

# THE 1/16 DIN COUNTERS



MODEL C48C INSTRUCTION MANUAL

## INTRODUCTION

*The C48 Counters (C48C) are a multi-purpose series of industrial control products that are field-programmable for solving various applications. This series of products is built around the concept that the end user has the capability to program different personalities and functions into the unit in order to adapt to different indication and control requirements.*

*The C48C unit, which you have purchased, has the same high quality workmanship and advanced technological capabilities that have made Red Lion Controls the leader in today's industrial market.*

*Red Lion Controls has a complete line of industrial indication and control equipment, and we look forward to servicing you now and in the future.*



**UL Recognized Component,  
File # E137808**



**CAUTION:**

Read complete instructions prior to installation and operation of the unit.



**CAUTION:**

Risk of electric shock.

## TABLE OF CONTENTS

<b>GENERAL DESCRIPTION</b> .....	1
Safety Summary .....	1
Block Diagram .....	2
<b>INSTALLATION &amp; CONNECTIONS</b> .....	3
Multiple Unit Stacking .....	3
Mounting Instructions .....	4
Unit Removal Procedure .....	4
Removing Unit Assembly .....	4
Installing Unit Assembly .....	5
Output Board .....	5
Replacing Relay Output Board .....	5
EMC Installation Guidelines .....	6
Wiring Connections .....	6
AC Versions (C48XX0X).....	7
DC Versions (C48CXX1X).....	7
Serial Communication Wiring.....	8
User Inputs.....	8
Output Wiring .....	8
Input A and Input/User B.....	8
Various Sensor Output Connections .....	10
<b>FRONT PANEL DESCRIPTION</b> .....	11
Keypad Functions.....	11
<b>BASIC OPERATION</b> .....	12
Single and Dual Preset Units .....	12
3 Preset Batch Unit .....	12
Normal Operating Mode .....	12
Modifying A Secondary Display Parameter From the Front Panel .....	12
Protected Value Menu .....	13
Front Panel Accessible Functions With Program Disable .....	14
<b>PROGRAMMING GENERAL DESCRIPTION</b> .....	15
Programming Option Values .....	15
Programming Numeric Data Values.....	15
Digit Entry .....	15

## TABLE OF CONTENTS (Cont'd)

Auto Scrolling.....	15
Saving Program.....	15
<b>USER INTERFACE/PROGRAMMING MODES</b> .....	<b>16</b>
Programming Menu.....	16
Numeric Value entry method.....	16
Access Prescaler Value.....	16
Prescaler (0.00001 - 9.99999*).....	16
Decimal Point Position.....	17
Count Input Mode.....	17
Count Modes.....	17
Counter (1) Operating Mode.....	18
Counter 2 Assignment (Batch Model only).....	20
Counter 2 Operating Mode (Batch Model only).....	21
Access Preset Values.....	22
Preset 1 Value.....	22
Preset 2 Value (Dual Preset/Batch Models only).....	22
Preset 3 Value (Batch Model only).....	22
Preset 1 Track Preset 2 (Dual Preset/Batch Models only).....	22
Access Output Time Values.....	23
Output Resolution.....	23
Output 1 Time Value.....	23
Output 2 Time Value (Dual Preset/Batch Models only).....	23
Output 3 Time Value (Batch Model only).....	23
Reverse Output Logic.....	23
Reverse Annunciator Logic.....	24
Output Power-Up State.....	24
User Inputs.....	24
User Input 1.....	25
User Input 2.....	25
User Input B.....	25
User F1 Key.....	25
Programming / Protected Parameter Menu Code Value (0-199).....	25
Scroll Display.....	26

## TABLE OF CONTENTS (Cont'd)

Serial Baud Rate and Parity Settings .....	26
Serial Unit Address (00-99) .....	26
Serial Abbreviate Mnemonics .....	26
Print Options .....	27
Print and Reset Count .....	27
Prescaler Output Pulse at [Prescaler Output Model Only] .....	27
Prescaler Output Pulse Length (1-9) [Prescaler Output Model Only] .....	27
Factory Settings .....	28
Factory Settings Chart .....	28
User Settings Chart .....	29
<b>RS-485 SERIAL COMMUNICATIONS</b> .....	<b>30</b>
Communication Format .....	30
Sending Commands and Data .....	30
Receiving Data .....	32
Terminal Emulation Program For IBM® PC .....	33
Serial Connections .....	33
Terminal Descriptions .....	33
Connecting To A Host Terminal .....	34
Troubleshooting Serial Communications .....	35
<b>PRESCALER OUTPUT OPTION</b> .....	<b>36</b>
<b>APPENDIX "A" - APPLICATION EXAMPLE</b> .....	<b>37</b>
<b>APPENDIX "B" - SPECIFICATIONS AND DIMENSIONS</b> .....	<b>39</b>
<b>APPENDIX "C" - TROUBLESHOOTING</b> .....	<b>43</b>
<b>APPENDIX "D" - CALCULATING THE PRESCALER</b> .....	<b>45</b>
<b>APPENDIX "E" - TERMINAL CONFIGURATIONS FOR C48 COUNTERS</b> .....	<b>46</b>
<b>APPENDIX "F" - ORDERING INFORMATION</b> .....	<b>48</b>



## GENERAL DESCRIPTION

The Model C48 Counter is available as a Standard Counter or a Batch Counter. The Standard Counter is available with single or dual presets. The Batch Counter has a main process counter with dual presets and a secondary counter with a single preset. The secondary counter can be selected to function as a batch or a total counter.

The C48C features a 7 segment, 2 line by 6 digit reflective or backlit LCD display. For the backlit versions, the main display line is red and shows the count value. When preset 3 or output 3 is viewed in the secondary display, the Batch/Total value is viewed in the main display. The smaller secondary display line is green and can be used to view the prescaler value, preset values, output time values or Batch/Total count values (Batch model).

The C48C offers a choice of nine programmable counting modes for use in applications requiring bi-directional, anti-coincidence, and quadrature counting. The unit may be programmed to register counts on both edges of the input signal providing frequency doubling capability. DIP switches are used for input configuration set-up and to provide a Program Disable function.

Four front panel push-buttons are used for programming the operating modes and data values, changing the viewed display, and performing user programmable functions, i.e. reset, etc. The C48C can be configured for one of two numeric data entry methods, digit entry or automatic scrolling. The digit entry method allows for the selection and incrementing of digits individually. The automatic scrolling method allows for the progressive change of one through all digit positions by pressing and holding the “up” or “down” button.

The C48 Counter has programmable User Inputs and a programmable front panel function key. The user inputs can be configured as sinking (active low) or sourcing (active high) inputs via a single plug jumper. The following functions are available for user inputs and the front panel function key.

Reset	Print Request
Store and Reset	Change Display
Program Disable	Count Inhibit
Store	Reset Outputs

The Program Disable DIP switch, a user-programmable code value, an external user input (selected for Program Disable), and the Accessible value

parameters can all be utilized to provide multi-level protection against unauthorized changes to data values and unit configuration.

The Standard Counter with Dual Presets is available with solid-state or Relay outputs. The Single Preset model has a solid-state and relay output. The Batch Counter has relay outputs for Output 2 and the Batch/Total Output (3), with Output 1 available as solid-state. The Batch Counter is also available with three solid-state outputs. For all C48 Counters, the solid-state outputs are available in a choice of NPN current sinking or PNP current sourcing, open-collector transistor outputs. All relay output boards are field replaceable.

A Prescaler Output model is available as a Dual Preset, with solid-state outputs. The Prescaler Output is useful for providing a lower frequency scaled pulse train to a PLC or another external totalizing counter. The Prescaler Output provides an output pulse for every count, or every 10 counts registered on the display.

Optional RS485 serial communication capabilities allow for interrogation and modification of the preset, count, and prescaler values.

Optional programming software (SFC48) is available to program all unit configuration parameters. The software allows unit configurations to be created, uploaded, downloaded, and saved to a file for later use or multi-unit programming.

The unit is constructed of a lightweight, high impact plastic case with a textured front panel and a clear display window. The front panel meets NEMA 4X/IP65 specifications for indoor use, when properly installed. Multiple units can be stacked horizontally or vertically. Modern surface-mount technology, extensive testing, plus high immunity to noise interference makes the C48 Counters extremely reliable in industrial environments.

## Safety Summary

All safety related regulations, local codes and instructions that appear in the manual or on equipment must be observed to ensure personal safety and to prevent damage to either the instrument or equipment connected to it. If equipment is used in a manner not specified by the manufacturer, the protection provided by the equipment may be impaired.

Do not use this unit to directly command motors, valves, or other actuators not equipped with safeguards. To do so, can be potentially harmful to persons or equipment in the event of a fault to the unit.

# BLOCK DIAGRAM

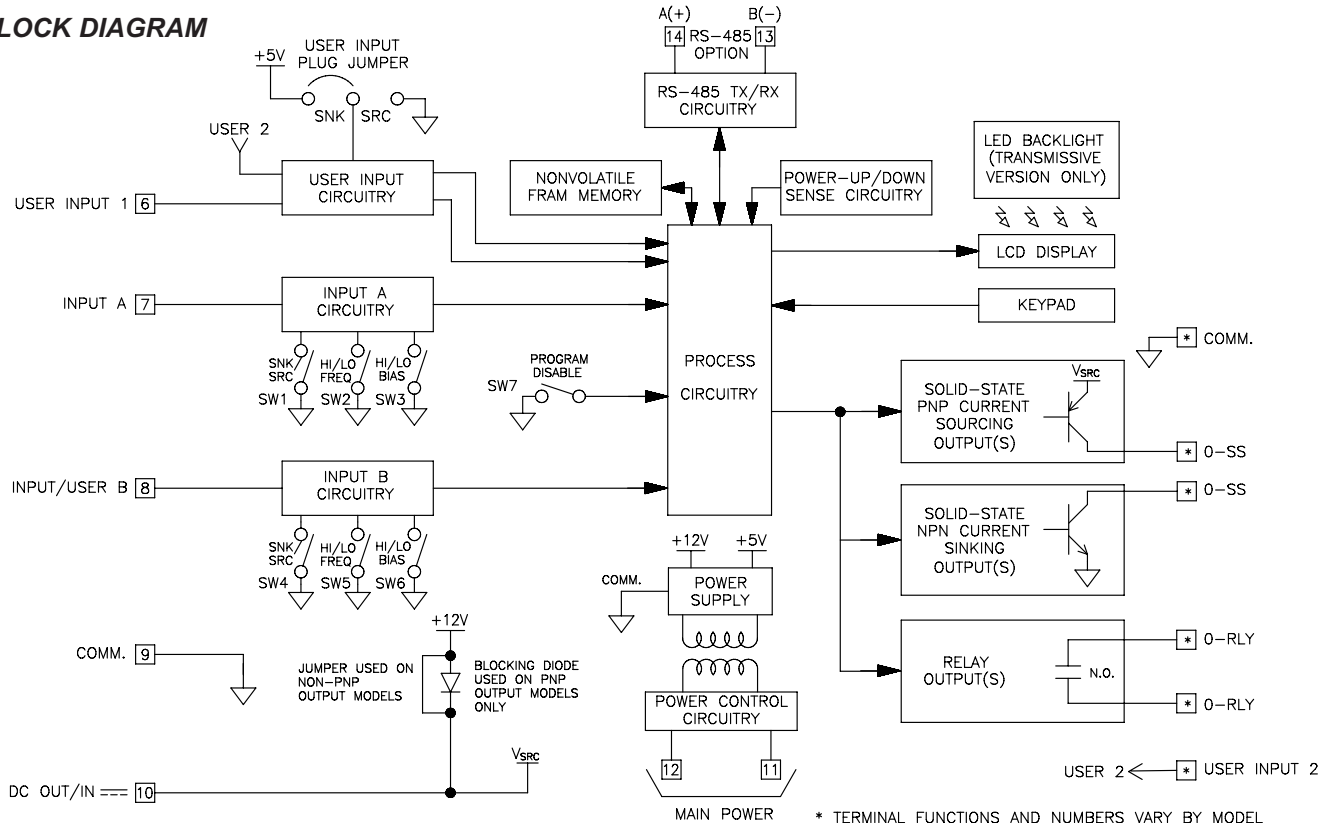

Figure 1, Block Diagram



## INSTALLATION & CONNECTIONS

The C48 Counter meets NEMA 4X/IP65 requirements for indoor use to provide a watertight seal in steel panels with a minimum thickness of 0.09 inch, or aluminum panels with a minimum thickness of 0.12 inch. The units are intended to be installed into an enclosed panel. The complete unit assembly (i.e. PC boards and bezel), **MUST** be in the case when mounting the unit.

### Multiple Unit Stacking

The C48C is designed for close spacing of multiple units. Units can be stacked either horizontally or vertically. For vertical stacking, install the panel latch with the screws to the sides of the unit. For horizontal stacking, the panel latch screws should be at the top and bottom of the unit. The minimum spacing from center line to center line of units is 1.96" (49.8 mm). This spacing is the same for vertical or horizontal stacking.

*Note: When stacking units, provide adequate panel ventilation to ensure that the maximum operating temperature range is not exceeded.*

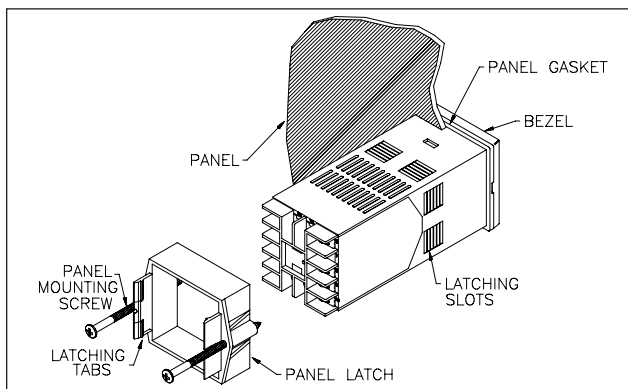

Figure 2, Panel Installation

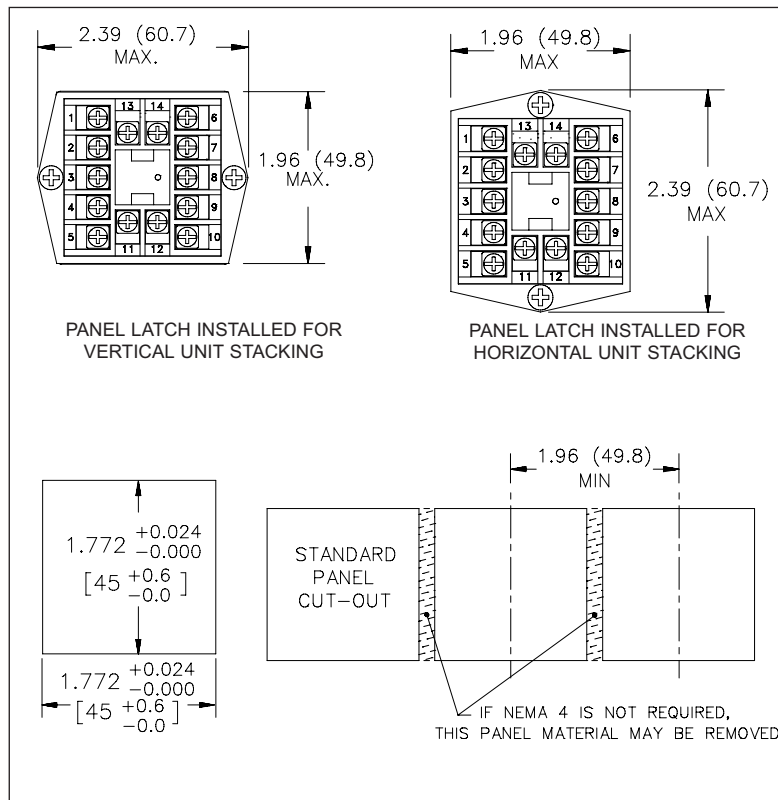

Figure 3, Multiple Unit Stacking

## Mounting Instructions

1. Prepare the panel cutout to the dimensions shown in Figure 3, Multiple Unit Stacking.
2. Remove the panel latch from the unit. Discard the cardboard sleeve.
3. Carefully remove the center section of the panel gasket and discard. Slide the panel gasket over the unit from the rear, seating it against the lip at the front of the case.
4. Insert the unit into the panel cutout. While holding the unit in place, push the panel latch over the rear of the unit, engaging the tabs of the panel latch in the farthest forward slot possible.
5. To achieve a proper seal, tighten the panel latch screws evenly until the unit is snug in the panel, torquing the screws to approximately 7 in-lbs. Overtightening can result in distortion of the panel, and reduce the effectiveness of the seal.

*Note: The installation location of the counter is important. Be sure to keep it away from heat sources (ovens, furnaces, etc.), and away from direct contact with caustic vapors, oils, steam, or any other process by-products in which exposure may affect proper operation.*



*Caution: Disconnect power to the unit and to the output control circuits to eliminate the potential shock hazard when removing the entire unit or unit assembly.*

## Unit Removal Procedure

To remove the entire unit with case and the panel, first loosen the panel latch screws. Insert flat blade screwdrivers between the panel latch and the case on either side of the unit, so that the latches disengage from the grooves in the case. Push the unit through the panel from the rear.

## Removing Unit Assembly

The unit assembly, shown in Figure 4, must be removed from the case to change DIP switch settings or to replace the relay output board. To remove the unit assembly, insert a flat blade screwdriver into the pry slot on either side of the unit. Twist the screwdriver handle until the unit is ejected enough to allow removal.

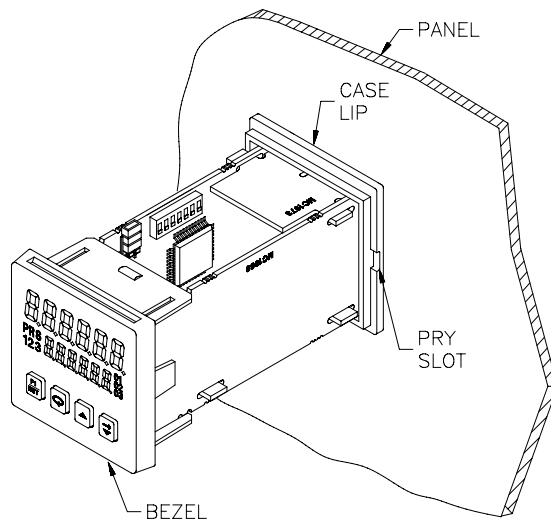

Figure 4, Unit Assembly

*Caution: The unit assembly contains electronic circuits that can be damaged by static electricity. Before removing the assembly, discharge static charge on your body by touching an earth ground point. It is also important that the unit assembly be handled only by the bezel. Additionally, if it is necessary to handle a circuit board, be certain that hands are free from dirt, oil, etc., to avoid circuit contamination that may lead to malfunction. If it becomes necessary to ship the unit for repairs, place the unit in its case before shipping it.*

## Installing Unit Assembly

To install the unit assembly, insert the assembly into the case until the bezel is fully seated against the lip of the case. Properly installing the unit assembly is necessary for watertight front panel sealing.

# Output Board

The C48C is supplied with an output board installed. The output board is preconfigured for the type of output needed, based upon the Model ordered. See Ordering Information, page 48, for available models. All relay output boards are field replaceable.

## Replacing Relay Output Board

1. Remove the unit assembly. (See Removing Unit Assembly, page 4).
2. Lift up on the top bezel board latch while gently pulling out on the bezel/display board assembly. Do NOT remove the display board from the bezel.
3. Remove the output board by pulling it away from the other boards. Replace the output board by aligning the board to board connectors. Be certain connectors are fully mated.
4. Connect the bezel/display board assembly by guiding the board ends into the bezel latches. Slide the assembly on evenly until the display board connector is completely engaged and bezel latches are fully seated onto the boards.

*Note: When replacing the relay output board, be certain to install a new output board of the same type.*

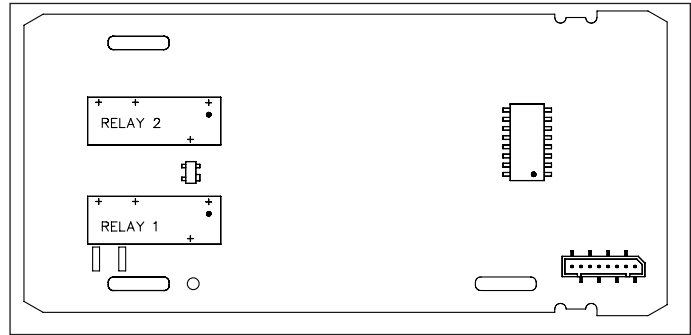

Figure 5, Relay Output Board

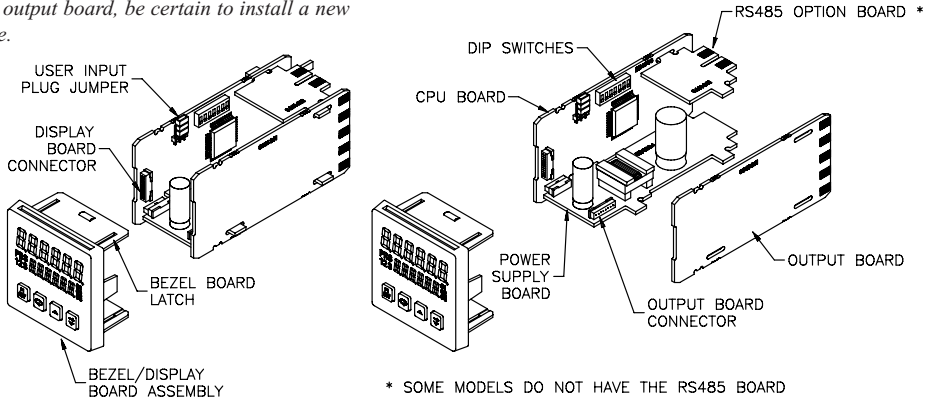

Figure 6, Relay Output Board Replacement

## EMC INSTALLATION GUIDELINES

Although this unit is designed with a high degree of immunity to Electro-Magnetic Interference (EMI), proper installation and wiring methods must be followed to ensure compatibility in each application. The type of electrical noise, source or coupling method into the unit may be different for various installations. The unit becomes more immune to EMI with fewer I/O connections. Cable length, routing and shield termination are very important and can mean the difference between a successful installation or a troublesome installation. Listed below are some EMC guidelines for successful installation in an industrial environment.

1. The unit should be mounted in a metal enclosure, that is properly connected to protective earth.
2. Use shielded (screened) cables for all Signal and Control inputs. The shield (screen) pigtail connection should be made as short as possible. The connection point for the shield depends somewhat upon the application. Listed below are the recommended methods of connecting the shield, in order of their effectiveness.
  - a. Connect the shield only at the panel where the unit is mounted to earth ground (protective earth).
  - b. Connect the shield to earth ground at both ends of the cable, usually when the noise source frequency is above 1 MHz.
  - c. Connect the shield to common of the unit and leave the other end of the shield unconnected and insulated from earth ground.
3. Never run Signal or Control cables in the same conduit or raceway with AC power lines, conductors feeding motors, solenoids, SCR controls, and heaters, etc. The cables should be run in metal conduit that is properly grounded. This is especially useful in applications where cable runs are long and portable two-way radios are used in close proximity or if the installation is near a commercial radio transmitter.
4. Signal or Control cables within an enclosure should be routed as far away as possible from contactors, control relays, transformers, and other noisy components.
5. In extremely high EMI environments, the use of external EMI suppression devices, such as ferrite suppression cores, is effective. Install them on Signal and Control cables as close to the unit as possible. Loop the cable through the

core several times or use multiple cores on each cable for additional protection. Install line filters on the power input cable to the unit to suppress power line interference. Install them near the power entry point of the enclosure. The following EMI suppression devices (or equivalent) are recommended:

Ferrite Suppression Cores for signal and control cables:

Fair-Rite # 0443167251 (RLC #FCOR0000)

TDK # ZCAT3035-1330A

Steward #28B2029-0A0

Line Filters for input power cables:

Schaffner # FN610-1/07 (RLC #LFIL0000)

Schaffner # FN670-1.8/07

Corcom #1VR3

*Note: Reference manufacturer's instructions when installing a line filter.*

6. Long cable runs are more susceptible to EMI pickup than short cable runs. Therefore, keep cable runs as short as possible.
7. Switching of inductive loads produces high EMI. Use of snubbers across inductive loads suppresses EMI.

Snubbers:  
RLC #SNUB0000

## Wiring Connections

All conductors should meet voltage and current ratings for each terminal. Also cabling should conform to appropriate standards of good installation, local codes and regulations. It is recommended that power supplied to the unit (AC or DC) be protected by a fuse or circuit breaker.

After the unit has been mechanically mounted, it is ready to be wired. All wiring connections are made to rear screw terminals. When wiring the unit, use the numbers on the label and those embossed on the back of the case, to identify the position number with the proper function. See page 46 for terminal descriptions. Strip the wire, leaving approximately 1/4" (6 mm) bare wire exposed (stranded wires should be tinned with solder). Insert the wire under the clamping washer and tighten the screw until the wire is clamped tightly.

*Caution: Unused terminals are NOT to be used as tie points. Damage to the counter may result if these terminals are used.*

## POWER WIRING

### AC Versions (C48CXX0X)

#### AC Power Wiring

Primary AC power is connected to terminals 11 and 12, labeled AC. To reduce the chance of noise spikes entering the AC line and affecting the counter, an AC feed separate from that of the load should be used to power the counter. Be certain that the AC power to the counter is relatively “clean” and within the specified range. Connecting power from heavily loaded circuits or circuits that also power loads that cycle on and off, (contacts, relays, motors, etc.) should be avoided.

#### DC Power Wiring (Non PNP Output models)

The DC power is connected to terminals 9 & 10, marked COMM. and DC OUT/IN. The DC power source must be capable of supplying the unit’s rated current (150 mA max.) and be within the specified 11 to 14 VDC range. The C48C has non-volatile memory that stores information on power down, thereby eliminating the need for battery back-up.

*Note: AC Versions with PNP outputs cannot be powered from DC.*



**CAUTION:** Observe proper polarity when connecting DC voltages. Damage to the unit will occur if polarity is reversed.

### DC Versions (C48CXX1X)

DC power (18 to 36 VDC) or low voltage AC power (24 VAC) is connected to terminals 11 and 12, labeled DC+ (AC) and DC- (AC) respectively.

#### Output Power

For DC/ Low Voltage AC units that do not have PNP current sourcing outputs, Terminal 10, DC OUT ( $V_{SRC}$  IN), provides a DC output for sensor power (+12 VDC +/-15%). The maximum sensor current is 100 mA.

For units with PNP current sourcing outputs, this terminal serves a dual purpose depending on the application’s PNP output voltage level and current requirements.

1. The terminal may be used as a +12 VDC output for sensor power. In this case, the PNP output voltage level will be +12 VDC ( $\pm 15\%$ ). A maximum of 100 mA is available for the combination of sensor current and PNP output sourcing current.
2. If a higher PNP output voltage level or additional output sourcing current is desired, an external DC supply may be connected between the “DC OUT ( $V_{SRC}$  IN)” and “COMM.” terminals. This supply will determine the PNP output voltage level, and must be in the range of +13 to +30 VDC.

An external DC supply can also provide the additional output sourcing current required in applications where two or more PNP outputs are “ON” simultaneously. However, the maximum current rating of 100 mA per individual output must not be exceeded, regardless of external supply capacity.

## Serial Communications Wiring

It is recommended that shielded (screened) cable be used for serial communications. This unit meets the EMC specifications using Alpha #2404 cable or equivalent. There are higher grades of shielded cable, such as four conductor twisted pair, that offer an even higher degree of noise immunity.

Refer to RS-485 Serial Communications, page 30, for wiring and operational procedures.

## User Inputs

The external user inputs are programmable inputs that can be configured as current sinking (active low) or current sourcing (active high) inputs via a single plug jumper. Programmable external user inputs are digital inputs. The use of shielded cable is recommended. Follow the EMC Installation Guidelines for shield connection. The active logic state of ALL user inputs is dictated by the position of the User Input plug jumper. The plug jumper is located on the CPU board to the left of the DIP switches (See Figure 7, User Input Jumper Location). Input/User B can be programmed to be a user input when only unidirectional counting is required (See CNT IN parameter, page 17). When programmed as a User Input, Input B's active logic level is also controlled by the User SNK/SRC plug jumper.

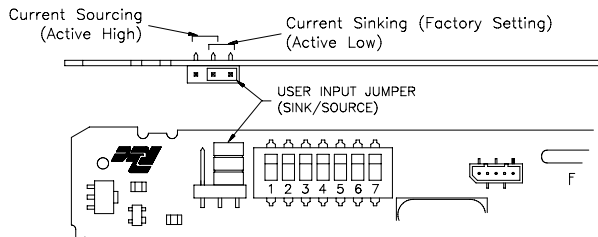

Figure 7, User Input Jumper Location

## OUTPUT WIRING

### Relay Connections

To prolong contact life and suppress electrical noise interference due to the switching of inductive loads, it is good installation practice to install a snubber across the contactor. Follow the manufacturer's instructions for installation.

*Note: Snubber leakage current can cause some electro-mechanical devices to be held ON.*

### Input A and Input/User B

Input A and Input B have identical circuitry and share the same "COMM." terminal. Each input has separate DIP switches that configure the circuitry to accept various types of sensor outputs.

The input schematic shows the details of the input circuitry. Each input has three DIP switches whose functions are listed below.

To access the DIP switches, the unit assembly must be removed from the case. See Removing The Unit Assembly, page 4, for instructions.

### INPUT A

**SW1 - SNK:** Provides a 7.8 K $\Omega$  internal pull-up resistor for sensors with current sinking outputs.

**SRC:** Provides a 3.9K $\Omega$  internal pull-down resistor for sensors with current sourcing outputs.

**SW2 - HI FRQ:** Removes damping capacitor and allows operation up to the maximum input frequency.

**LO FRQ:** Connects damping capacitor for switch contact debounce. Limits count speed to 50 Hz maximum and count pulse ON or OFF times to 10 msec. minimum.

*Note: The HI/LO FRQ selection switch must be set on "LO FRQ" when switch contacts are used to generate count input signals. The "LO FRQ" mode also provides very high immunity against electrical noise pickup. It is recommended that this mode also be used, whenever possible, with electronic sensor outputs. The "LO FRQ" mode can be used with any type of sensor output, provided count pulse widths never decrease below 10 msec, and the count rate does not exceed 50 Hz.*

**SW3 - HI BIAS:** Sets input trigger levels at mid-range, to accept outputs from 2-wire proximity sensors, resistive photo-cells, and logic pulses with full 0 to +12V swings.

Input trigger levels:  $V_{IL} = 5.5 \text{ V max}$ ;  $V_{IH} = 7.5 \text{ V min}$ .

**LO BIAS:** Sets input trigger levels to low range, to accept logic pulses with 0 to +5 V swings.

Input trigger levels:  $V_{IL} = 1.5 \text{ V max}$ ;  $V_{IH} = 3.75 \text{ V min}$ .

*Note:  $V_{IL}$  and  $V_{IH}$  levels given are typical values  $\pm 10\%$ , when the counter voltage at the DC OUT/IN terminal, is +12 VDC. These typical values will vary in proportion to the variations in DC OUT/IN terminal voltage, caused by line voltage and load changes.*

### INPUT B

**SW4** - Same as SW1

**SW5** - Same as SW2

**SW6** - Same as SW3

**SW7 - PGM.DIS.:** See Front Panel Accessible Functions With Program Disable, page 14, for details.

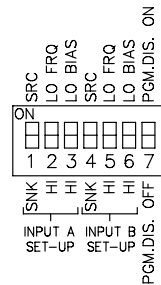

Figure 8, DIP Switches

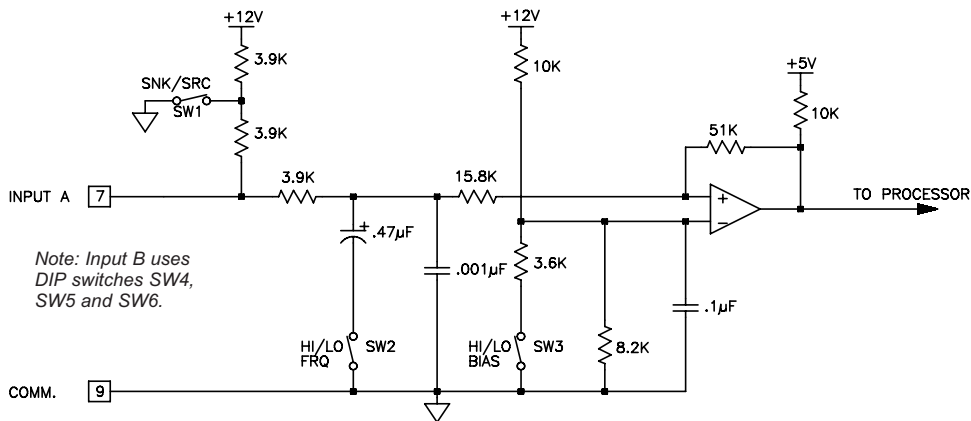

Figure 9, Input Circuit Schematic

# Various Sensor Output Connections

**COUNT SWITCH OR ISOLATED TRANSISTOR OUTPUTS**  
CURRENT SOURCE CONNECTED (COUNT ON OPENING)

RLC SENSOR MODELS:  
MPS, PR, AND RR PHOTO-ELECTRICS \* SEE NOTE 2

Terminal connections:  
 6 USER INPUT 1  
 7 INPUT A  
 8 INPUT/USER B  
 9 COMM.  
 10 DC OUT/IN

Switch/Transistor connections:  
 SRC (Source)  
 ON (Switch position)  
 SINK (Sink)  
 FRQ (Frequency)  
 LO (Low)  
 HI (High)  
 BIAS (Bias)

**OLDER STYLE SENSORS WITH E-F OUTPUT - CURRENT SOURCE CONNECTED (COUNT ON FALLING EDGE)**

SENSOR

RLC SENSOR MODELS: LMP-EC \* SEE NOTE 2

Terminal connections:  
 6 USER INPUT 1  
 7 INPUT A  
 8 INPUT/USER B  
 9 COMM.  
 10 DC OUT/IN

Switch/Transistor connections:  
 SRC (Source)  
 ON (Switch position)  
 SINK (Sink)  
 FRQ (Frequency)  
 LO (Low)  
 HI (High)  
 BIAS (Bias)

**CURRENT SINK CONNECTED (COUNT ON CLOSING)**

RLC SENSOR MODELS:  
MPS, PR, AND RR PHOTO-ELECTRICS \* SEE NOTE 2

Terminal connections:  
 6 USER INPUT 1  
 7 INPUT A  
 8 INPUT/USER B  
 9 COMM.  
 10 DC OUT/IN

Switch/Transistor connections:  
 SRC (Source)  
 ON (Switch position)  
 SINK (Sink)  
 FRQ (Frequency)  
 LO (Low)  
 HI (High)  
 BIAS (Bias)

**2 WIRE PROXIMITY SENSORS - CURRENT SOURCE CONNECTED (COUNT ON CURRENT FALL)**

RLC SENSOR MODELS:  
PSA-1  
PSA-2

\* SEE NOTE 2

Terminal connections:  
 6 USER INPUT 1  
 7 INPUT A  
 8 INPUT/USER B  
 9 COMM.  
 10 DC OUT/IN

Switch/Transistor connections:  
 SRC (Source)  
 ON (Switch position)  
 SINK (Sink)  
 FRQ (Frequency)  
 LO (Low)  
 HI (High)  
 BIAS (Bias)

**SENSORS WITH CURRENT SOURCE OUTPUT (PNP O.C.) (COUNT ON TURN-OFF)**

SENSOR

\* SEE NOTE 2

Terminal connections:  
 6 USER INPUT 1  
 7 INPUT A  
 8 INPUT/USER B  
 9 COMM.  
 10 DC OUT/IN

Wire colors:  
 WHT (White)  
 BLK (Black)  
 RED (Red)

Switch/Transistor connections:  
 SRC (Source)  
 ON (Switch position)  
 SINK (Sink)  
 FRQ (Frequency)  
 LO (Low)  
 HI (High)  
 BIAS (Bias)

**INTERFACING WITH TTL**

NOTE: CIRCUIT SHOWN FOR STD. TTL OUTPUT. TTL CIRCUITS ARE AVAILABLE WITH OPEN COLLECTOR OUTPUTS, ELIMINATING THE NEED FOR A CLAMP DIODE.

Terminal connections:  
 6 USER INPUT 1  
 7 INPUT A  
 8 INPUT/USER B  
 9 COMM.  
 10 DC OUT/IN

Switch/Transistor connections:  
 SRC (Source)  
 ON (Switch position)  
 SINK (Sink)  
 FRQ (Frequency)  
 LO (Low)  
 HI (High)  
 BIAS (Bias)

**SENSORS WITH CURRENT SINK OUTPUT (NPN O.C.) (COUNT ON TURN-ON)**

SENSOR

RLC SENSOR MODELS: ASTC, LMPC, PSAC, LSC, RPGC, RPGB, RPHG, RPHN, RPHG, RPHG, RPHG, HESS \* SEE NOTE 2

Terminal connections:  
 6 USER INPUT 1  
 7 INPUT A  
 8 INPUT/USER B  
 9 COMM.  
 10 DC OUT/IN

Wire colors:  
 WHT (White)  
 BLK (Black)  
 RED (Red)

Shielding: SHIELD SEE NOTE 3

Switch/Transistor connections:  
 SRC (Source)  
 ON (Switch position)  
 SINK (Sink)  
 FRQ (Frequency)  
 LO (Low)  
 HI (High)  
 BIAS (Bias)

**INTERFACING WITH CMOS CIRCUITRY (B TYPE)**

NOTE: IF EXTERNAL SUPPLY IS USED TO POWER CMOS CIRCUIT, VOLTAGE MUST BE EQUAL TO OR GREATER THAN DC OUT VOLTAGE.

Terminal connections:  
 6 USER INPUT 1  
 7 INPUT A  
 8 INPUT/USER B  
 9 COMM.  
 10 DC OUT/IN

Switch/Transistor connections:  
 SRC (Source)  
 ON (Switch position)  
 SINK (Sink)  
 FRQ (Frequency)  
 LO (Low)  
 HI (High)  
 BIAS (Bias)

## NOTES:

- 1. SENSOR VOLTAGE AND CURRENT**  
The DC OUT/IN terminal can supply +12 VDC @ 100 mA max. within a  $\pm 15\%$  range, due to line and internal load variations. Most RLC sensors will accommodate this range.
- 2. HI/LO FRQ SELECTION**  
The HI/LO FRQ selection switch must be set on "LO FRQ" when switch contacts are used to generate count input signals. The "LO FRQ" mode also provides very high immunity against electrical noise pickup. It is recommended that this mode also be used, whenever possible, with electronic sensor outputs. The "LO FRQ" mode can be used with any type of sensor output, provided count pulse widths never decrease below 10 msec, and the count rate does not exceed 50 Hz.
- When shielded cable is used, connect the shield to "COMM." at the counter and leave it disconnected at the sensor end.
- Inputs A and B can accept source pulses from other circuits up to +30 V in amplitude. For voltages above +30 V, a limiting resistor and zener diode should be used to limit the voltage at the input terminal.



## FRONT PANEL DESCRIPTION

The front panel bezel material is flame and scratch resistant, textured plastic with clear viewing window that meets NEMA 4X/IP65 requirements, when properly installed. Continuous exposure to direct sunlight might accelerate the aging process of the plastic material used in the bezel. The bezel should be cleaned only with a soft cloth and neutral soap product. Do NOT use solvents.

The display is a dual line, 6 digit LCD. On units with backlighting, the upper Main Display is red and the lower Secondary Display is green.

There are up to seven annunciators available in the lower display that illuminate to inform the operator of the counter and output status. See Figure 10, Front Panel, for a description of the annunciators.

Four front panel keys are used to access different modes and parameters. The following is a description of each key.

*Do not use tools of any kind (screwdrivers, pens, pencils, etc.) to operate the keypad of this unit.*

### Keypad Functions

 - This key is a user programmable key. When the key is pressed, the unit performs the appropriate function as programmed. The RST printing on this key is used as a quick reference for the operator if the function key is selected for a reset function.

 - This key is used to access programming, enter changes to data values, and scroll through the available parameters in any mode.

**VALUE ANNUNCIATORS**  
Indicate which value is being viewed or modified.

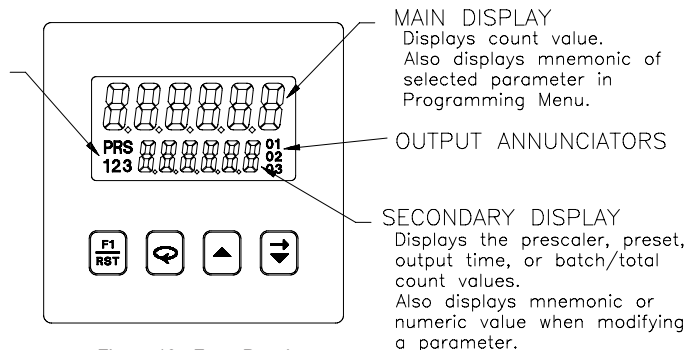



Figure 10 , Front Panel

-  - This key selects the next available mode option during programming. When programming a numerical value in digit entry mode, this key is used to increment the selected digit position. In auto scrolling entry mode, it increments the value. When in the operating mode, this key is pressed to allow changing of the data value viewed in the secondary display.
-  - When programming a numerical value in digit entry mode, this key accesses the value and selects the digit to the right. In auto scrolling entry mode, it decrements the value. When in the operating mode, this key is pressed to allow changing of the data value viewed in the secondary display.

## **BASIC OPERATION**

### **Single and Dual Preset Units**

The C48CS and C48CD have one counter that keeps track of the input pulse count. On each counter edge, the prescaler value is added to or subtracted from the count value. This results in the desired reading value for the count display.

The counter has two reset action modes; Reset to Zero (up-count modes) and Reset to Preset (down-count modes). A reset can be a manual reset, using a programmable user input, or it can be one of the programmable automatic reset modes.

The counter displays the scaled number of pulses that have been entered. When the count equals either preset 1 or 2, depending on the model, the appropriate output activates. The count can be programmed to automatically reset if desired.

### **3 Preset Batch Unit**

The C48CB contains two counters that keep track of the Process Count, and the Batch or Total Count. On each count edge, the prescaler value is added to or subtracted from the count input value. This results in the desired reading value for the process or total count displays. The batch count registers one count each time the process is completed.

The process counter has two reset action modes; Reset to Zero (up-count modes) and Reset to Preset (down-count modes). A reset can be a manual reset, using a programmable user input, or it can be one of the programmable automatic reset modes.

The batch counter displays the number of process cycles that have been completed.

The total count is the total number of counts that have been received since the total was last reset. It can be used to keep a running total of process units on a desired per shift, per day, per week, etc. basis.



### **Normal Operating Mode**

In the normal operating mode, the count or batch/total value is shown on the main display. By successively pressing the  key, the accessible presets, prescaler, output time values, or batch/total count can be viewed in the secondary display.

With the exception of the batch/total count, each of the values can be independently programmed to be viewable only, viewable and changeable, or locked (not viewable) in the normal operating mode. On the batch models, if all values are locked, only the batch/total count value is viewable in the secondary display. On single or dual preset models, the display will be blank. Only from the normal operating mode can access be gained to the Programming Menu or Protected Value Menu.

### **Modifying A Secondary Display Parameter From the Front Panel**

Secondary display parameters can be modified from the normal operating mode if the Operator Access privileges allow it.

To modify a parameter, it must be viewed in the secondary display. When the parameter to be modified is viewed, press the  or  key. Leading zeros appear and the least significant digit blinks. The value can now be modified as described in Programming Numeric Data Values, page 15.

## Protected Value Menu

The Protected Value Menu allows access to selected presets, prescaler, and output time values without having them viewable or changeable from the main display. To enter the protected menu, the  key is pressed and held, and a code value is entered. The Protected Value Menu and the Programming Menu are not available at the same time. See Front Panel Accessible Functions With Program Disable, page 14, for available options.

Access value parameters that are programmed for “P” or “n” are accessible in the Protected Value Menu. Parameters selected as “n” (no) are viewable from the main display, but can only be changed in the protected menu. Parameters selected as “P” (protected) are not viewable from the main display, but can be viewed and changed in the protected menu.

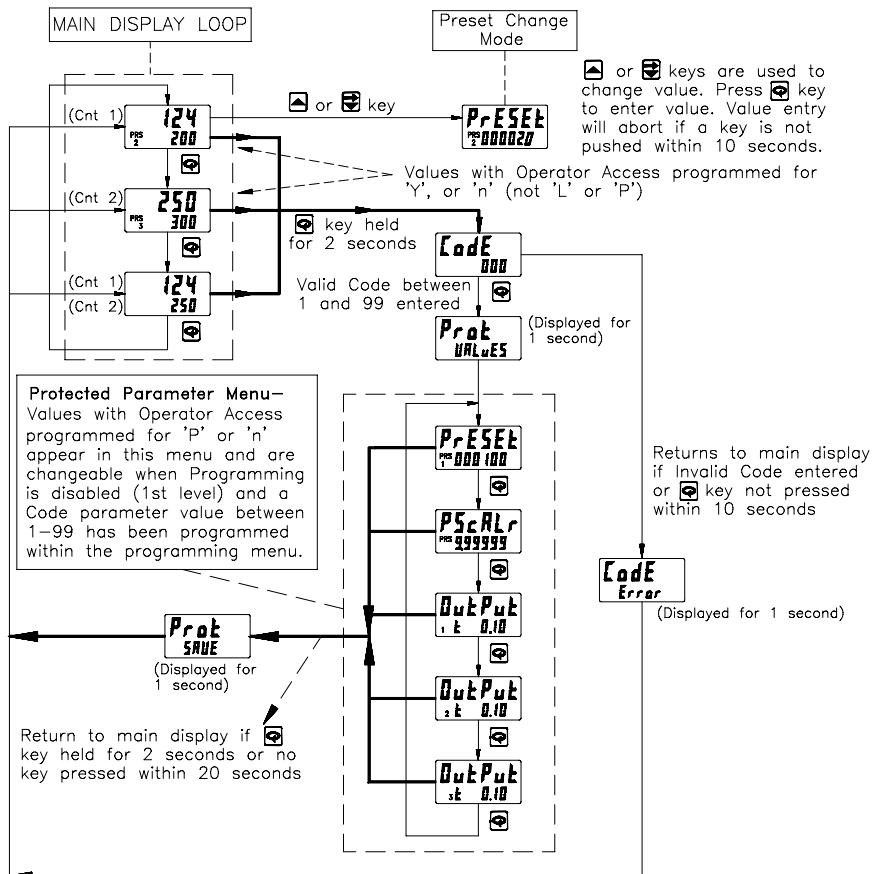

Figure 11, Protected Value Menu

## Front Panel Accessible Functions With Program Disable







There are several ways to limit the programming of parameters from the front panel keypad. The Accessible Value parameters are used with the Program Disable DIP switch and an external programmable User Input selected for *Pro.d* 5 to limit programming. To enter the programming mode, a code number

may need to be entered, depending on the Program Disable Setting. Front Panel Function Key F1 cannot be selected for program disable. The following table describes the possible program disabling functions.





PGM.DIS. SWITCH	USER INPUT TERMINAL	PROGRAM CODE NUMBER	PROTECTED VALUE MENU	OPERATOR ACCESS AT MAIN DISPLAY	PROGRAMMING ENABLED	PROGRAM DISABLE LEVEL
OFF	INACTIVE or Not Programmed for Pro.dis	ALL	No	All displayed values changeable	Yes	None
OFF	ACTIVE	0	No	Per Access Privileges programmed	No	Level 1
OFF	ACTIVE	1 to 99	Yes W/code	Per Access Privileges programmed	No	Level 1
OFF	ACTIVE	100 to 199	No	Per Access Privileges programmed	Yes W/code	Level 1
ON	INACTIVE or Not Programmed for Pro.dis	0	No	Per Access Privileges programmed	No	Level 1
ON	INACTIVE or Not Programmed for Pro.dis	1 to 99	Yes W/code	Per Access Privileges programmed	No	Level 1
ON	INACTIVE or Not Programmed for Pro.dis	100 to 199	No	Per Access Privileges programmed	Yes W/code	Level 1
ON	ACTIVE	ALL	No	Viewable only	No	Level 2

## PROGRAMMING GENERAL DESCRIPTION

Programming of the C48 Counter is done through the front panel keypad. English language prompts, flashing parameter values, and the front panel keypad aid the operator during programming.



Although the unit has been programmed at the factory, the parameters generally have to be changed to suit the desired application. In order to access the Programming Menu, the Program Disable DIP switch and/or any User Input programmed for *Prod 15* may need to be turned off or deactivated. When shipped from the factory, all programming is enabled. See Front Panel Accessible Functions With Program Disable, page 14, for program disabling options. With programming enabled, to enter the programming menu, the  key is pressed and held for two seconds. Once in the programming menu, the  key is used to sequence through the list of programming parameters. To loop backwards one item in the Programming Menu, press and hold the  key, then quickly press and hold the  key while releasing the  key. Repeatedly pressing the  key with the  key held will continue the backwards sequencing.

### Programming Option Values



The operator can scroll through the available options for a selected parameter by pressing the  or  keys to enter parameter change mode, and then pressing the  key repeatedly until the desired option is viewed. The option is entered by pressing the  key, which returns the operator to the Programming Menu.

### Programming Numeric Data Values



The presets, prescaler, and output time values may be accessible when the unit is in the normal operating mode (not programming mode), providing that the Program Disable input is not activated. Pressing the  key will sequence the secondary display through the available presets, prescaler, and output time values.

To change a numeric data value it must be visible on the secondary display. Pressing the  or  key will allow changing of the value. The two methods for changing numeric data values are “digit entry” and “auto scrolling”.





### Digit Entry

If the data entry method has been set to “digit entry”, the least significant digit will blink. Pressing the  key multiple times will select other digits. Pressing the  key will increment the selected digit. The data value will be entered when the  key is pushed, or the old value will be retained if no key activity is detected for 10 seconds.





### Short-Cut - Decrementing Value

To decrement a digit value, press and hold the  key and then press the  key. This will decrement the selected digit to zero if held.

### Auto Scrolling

If the data entry method is set to “auto scrolling”, the data value can be progressively changed by pressing and holding the  or  keys. If one of the keys is pushed and held, the value will scroll automatically. After 5 counts, the unit enters fast scroll mode. If a key remains pushed, a digit shift occurs every one hundred counts until the maximum value or zero is reached. When the digit shift occurs, the previously scrolling digit goes to zero. When scrolling at the higher order digit locations, you can switch directions by quickly pressing the other key ( or ) within a second following the release of previous direction key.

### Short-Cut - Quick Digit Shift

To quickly select higher order digits while incrementing or decrementing numeric values (with  or  held), press and hold the  key. This sequences the selected digit from the least to the most significant digit. As each digit is passed, it changes to zero. When the desired digit is reached, release the  key to increment or decrement from the new digit location.

### Saving Program

All parameter values changed in programming mode are saved when exiting. To exit programming mode, press and hold the  key for two seconds. The display will momentarily display *Prod 9 SAVE* while the parameter values are saved in non-volatile memory. The unit then returns to the indication display that was last viewed.

## USER INTERFACE/PROGRAMMING MODES

The operating modes of the C48 Counter are programmed using the front panel keypad. Accessibility to the Programming Menu depends on the Program Disable Function setting (See Front Panel Accessible Functions With Program Disable, page 14, for available settings).

*Note: Before attempting to program the C48C, read the section Programming General Description, page 15, for detailed information on using the front panel keypad to navigate through the Programming Menu.*

### Programming Menu



#### Numeric Value entry method

Configures push button response for entering numeric data values such as Presets, Prescaler, and Output Times.

MODE	DESCRIPTION
<b>AutoSc</b>	The auto scrolling method allows pressing and holding the “up” or “down” keys to progressively change all digits of the data value, similar to incrementing or decrementing a counter.
<b>digit</b>	The digit entry method allows the selecting and incrementing of each numeric digit on an individual digit-by-digit basis.

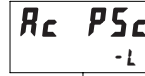

#### Access Prescaler Value

This parameter configures the type of access given to the Prescaler Value when in normal operating mode with Programming disabled. For more information on Program Disable, see page 14.

MODE	DESCRIPTION
<b>-L</b>	<b>Locked;</b> Prescaler is not viewable at main display or in Protected Value Menu. The Prescaler can only be viewed or changed in the Programming Menu.
<b>-P</b>	<b>Protected Value;</b> Prescaler value is viewable and changeable in Protected Value Menu only. It is not viewable at Main Display.
<b>-n</b>	<b>No;</b> Prescaler value is viewable only and not changeable from main display when Programming is Disabled. Value is viewable and changeable in Protected Value Menu.
<b>-y</b>	<b>Yes;</b> Prescaler value is viewable and changeable at main display when at 1st level program disable. Value is not shown in Protected Value Menu.



#### Prescaler (0.00001 - 9.99999\*)

The Prescaler is used to convert a pulse input signal to the desired units of indication. For each pulse input, the Prescaler value is added to or subtracted from the internal count value. A prescaler of 1.00000, provides unity scaling, i.e., for every pulse input, the display changes by 1. The prescaler value selected will affect the maximum count rate (See Appendix B - Specifications, page 39).

It is important to note that the precision of a counter application cannot be improved by using a prescaler greater than 1.

*\*Limited to 1.00000 or less on Prescaler Output Model or when Counter 2 is assigned to total on the Batch Counter.*

DEC Pt  
-----

## Decimal Point Position

Programmable for display of 0 to 5 digits right of decimal point.

MODE	DESCRIPTION
-----	No decimal Point
-----.	Decimal point for 10ths
-----..	Decimal point for 100ths
-----...	Decimal point for 1000ths
-----....	Decimal point for 10,000ths
-----.....	Decimal point for 100,000ths

Count In  
C1-Ud

## Count Input Mode

This parameter controls the Count / Control function of Inputs A and B. It also allows Input B to be used as a User Input when only uni-directional counting is required.

MODE	Input A	Input B
C1-USr*	Count X1; Count on falling edge	User Input B (See UsrInb parameter)
C2-USr	Count X2; Counts on both edges	User Input B (See UsrInb parameter)
C1-Ud*	Count X1; Counts on falling edge	Up/Down control; Input B high = Up Input B Low = Down
C2-Ud	Count X2; Counts on both edges	Up/Down control; Input B high = Up Input B Low = Down
Ad-Sub	Add count; Counts on falling edge	Subtract count; Counts on falling edge
Ad-Ad	Add count; Counts on falling edge	Add count; Counts on falling edge
QUAd 1	Quadrature X1 Input	Quadrature X1 Input
QUAd 2	Quadrature X2 Input	Quadrature X2 Input
QUAd 4	Quadrature X4 Input	Quadrature X4 Input

\*- These are the only count input modes available on the Prescaler Output model.

## Count Modes

Input A signal is used for the count input. Input B is used in combination with Input A for Count Direction Control, Quadrature counting, Anti-coincidence Add/Subtract, or Anti-coincidence Add/Add counting applications.

**C1-USR** - The unit counts one count on every negative edge of the input signal at Input A. In this mode, Input B acts as a user input and has no effect on the count function.

**C2-USR** - The unit counts one count on every negative edge of the input signal and one count on every positive edge of the input signal at Input A. In this mode, the input signal is effectively doubled. Input B acts as a user input and has no effect on the count function.

**C1-UD** - The unit counts one count on every negative edge of the input signal at Input A. The direction of the count is determined by the logic state of Input B. A high level at Input B causes the unit to count in a positive direction. A low level causes the unit to count in a negative direction.

**C2-UD** - The unit counts one count on every negative edge of the input signal and one count on every positive edge of the input signal at Input A. In this mode, the input signal is effectively doubled. The direction of the count is determined by the logic state of Input B. A high level at Input B causes the unit to count in a positive direction. A low level causes the unit to count in a negative direction.

**AD-SUB** - This mode effectively separates count pulses that may simultaneously appear at the two inputs. The C48C processes the count pulses into a string of time separated pulses, so the internal counter does not miss any count pulses. Input A serves as the add input (count increments) and Input B serves as the subtract input (count decrements).

**AD-AD** - This mode effectively sums count pulses that may simultaneously appear at the two inputs. The C48C processes the count pulses into a string of time-separated pulses so the internal counter does not miss any count pulses. Input A serves as an add input (count increments) and Input B serves as an additional add input (count increments).

**QUAD 1** - Quadrature counting modes are primarily used in positioning and anti-jitter applications. This mode works due to the manner in which the two incoming pulses are positioned relative to each other. The pulse signal on Input B is shifted 90° away from the pulse signal at Input A. These two signals are processed by the C48C as follows:

Input A serves as the count input, while Input B serves as the quadrature input. For quadrature with single edge counting, the counter counts in a positive direction when Input A is a negative going edge and Input B is at a low level. The counter counts in a negative direction when Input A is a positive going edge and Input B is at a low level. All transitions on Input A are ignored when Input B is at a high level. These logic rules provide the basis for anti-jitter operation which prevents false counts from occurring due to back-lash, vibration, chatter, etc.

**QUAD 2** - When two edge counting is used, the quadrature mode works the same as with single edge counting when Input B is low. But, when Input B is a high level, counts at Input A are no longer ignored. Instead, the logic rules for Input A are complemented, allowing both edges of Input A to be counted. This doubles the effective resolution of the encoded input.

**QUAD 4** - This takes the quadrature mode, with two edge counting, one step further. In quadrature times 4, both Input A and Input B serve as the count or quadrature input, depending on their state. In one instance, Input A serves as the count input and Input B serves as the quadrature input. In another instance, Input A is the quadrature input and Input B is the count input. This enables each edge, positive and negative going, of both inputs, A and B, to be counted. This results in a resolution four times greater than in the basic quadrature X1 mode.

## Counter (1) Operating Mode

Single or Dual  
Preset Model



The charts on the following pages show operating modes for Single Preset and the Dual Preset / Batch Counter Models. In the descriptions below the “Main Preset or Output” refers to “Preset or Output 1” on the Single Preset Model. On the Dual Preset or Batch Models it refers to “Preset or Output 2”.

Batch Model



**Reset Type:**

**Auto** - unit automatically resets when count triggers main preset's output or at its timed output end, as programmed.

**Manual** - unit does not reset when count triggers main presets output or at its timed output end. The counter can be manually reset by a User Input or by a Serial Communications command.

**Reset to:**

**Zero** - When reset (manually or automatically) counter goes to zero. The Main Preset Output is triggered when count value reaches main Preset Value

**Preset** - When reset (manually or automatically), the main Preset value is loaded into the counter. The main Preset Output is triggered when count reaches zero.

**At Timed Output End:**

When this mode is selected, Auto Reset occurs when the main preset's Output time elapses and the main output deactivates. If not selected, Auto reset occurs when the main output is triggered.

**Output 1:** (Main Output for Single Preset Model)

**Latched** - When Output 1 activates, it stays activated or latched until it is manually reset.

**Timed** - When Output 1 is activated it stays activated for the time specified by the Output 1 Time Value. Output 1 deactivates after the Output 1 time elapses.

**O1 Off at O2:** (Dual Preset / Batch Model only)

Output 1 activates at Preset 1. It deactivates when Output 2 is activated. Does not apply when activating Output 2 using Serial Communications command.

**Output 2:** (Dual Preset / Batch Model only; Main Output)

Operates similarly to Output 1 Latched and Timed modes.



### SINGLE PRESET OPERATING MODES

Use either of the two charts below for more information on specific operating modes.

SINGLE PRESET OPERATING MODES	
1	- Manual Reset to Zero, Latched Output
2	- Manual Reset to Zero, Timed Output
3	- Manual Reset to Preset, Latched Output
4	- Manual Reset to Preset, Timed Output
5	- Auto Reset to Zero, Timed Output
6	- Auto Reset to Preset, Timed Output
7	- Auto Reset to Zero at Timed Output End
8	- Auto Reset to Preset at Timed Output End

MODE#	RESET TYPE		RESET			OUTPUT 1	
	Manual	Auto	To Zero	To Preset	at Timed Output End	Latched	Timed
1	√		√			√	
2	√		√				√
3	√			√		√	
4	√			√			√
5		√	√				√
6		√		√			√
7		√	√		√		√
8		√		√	√		√

### DUAL PRESET/ BATCH COUNTER 1 OPERATING MODES

Use either of the two charts below for more information on specific operating modes.

DUAL PRESET AND BATCH COUNTER 1 OPERATING MODES	
1	- Manual Reset to Zero, Latched Outputs
2	- Manual Reset to Zero, 01 Timed, 02 Latched
3	- Manual Reset to Zero, 01 and 02 Timed
4	- Manual Reset to Zero, 01 off at 02, 02 Latched
5	- Manual Reset to Zero, 01 off at 02, 02 Timed
6	- Manual Reset to Preset 2, Latched Outputs
7	- Manual Reset to Preset 2, 01 Timed, 02 Latched
8	- Manual Reset to Preset 2, 01 and 02 Timed
9	- Manual Reset to Preset 2, 01 off at 02, 02 Latched
10	- Manual Reset to Preset 2, 01 off at 02, 02 Timed
11	- Auto Reset to Zero, 01 and 02 Timed
12	- Auto Reset to Zero, 01 off at 02, 02 Timed
13	- Auto Reset to Preset 2, 01 and 02 Timed
14	- Auto Reset to Preset 2, 01 off at 02, 02 Timed
15	- Auto Reset to Zero at 02 End, 01 and 02 Timed
16	- Auto Reset to Zero at 02 End, 01 off at 02, 02 Timed
17	- Auto Reset to Preset 2 at 02 End, 01 and 02 Timed
18	- Auto Reset to Preset 2 at 02 End, 01 off at 02, 02 Timed

## DUAL PRESET/ BATCH COUNTER 1 OPERATING MODES

MODE#	RESET TYPE		RESET			OUTPUT 1			OUTPUT 2	
	Manual	Auto	To Zero	To Preset 2	at Timed 02 End	Latched	Timed	O1 Off at O2	Latched	Timed
1	√		√			√			√	
2	√		√				√		√	
3	√		√				√			√
4	√		√					√	√	
5	√		√					√		√
6	√			√		√			√	
7	√			√			√		√	
8	√			√			√			√
9	√			√				√	√	
10	√			√				√		√
11		√	√				√			√
12		√	√					√		√
13		√		√			√			√
14		√		√				√		√
15		√	√		√		√			√
16		√	√		√			√		√
17		√		√	√		√			√
18		√		√	√			√		√

## Counter 2 Assignment (Batch Model only)

This parameter configures Counter 2 to function as a Batch or Total Counter.



### MODE DESCRIPTION

**batch** Counter 2 operates as a batch counter. A batch is counted when Output 2 of Counter 1 is triggered. The Count direction is determined by the Counter 2 Operating Mode.

**total** Counter 2 operates as a totalizing counter. The totalizer counts whenever Counter 1 increments or decrements. The count direction is determined by; Counter 1 count direction, Counter 1 Operating "Reset to" mode, and the Counter 2 Operating "Reset to" mode.

### Counter 2 Count Direction when configured as a Totalizer

COUNTER 1 COUNT DIRECTION FOR C1 OPERATING MODE		RESULTANT COUNTER 2 COUNT DIRECTION FOR C2 OPERATING MODE		NOTES
Reset to 0	Reset to P2	Reset to 0	Reset to P3	Count Reset Modes
Up	Dn	Up	Dn	Normal Count Direction
Dn	Up	Dn	Up	Reversed Count Direction

When Counter 2 is assigned to Total, the Prescaler value is limited to 1.00000 or less. For Prescaler values less than one, that are not evenly divisible into the Preset 2 value, the Total count incurs an accumulating error of up to 1 count for every auto reset cycle of Counter 1. In effect, it does not accumulate the "total" amount of material used, it accumulates the "total" number of counts registered in Counter 1.

## Counter 2 Operating Mode (Batch Model only)



### Reset Type:

**Auto** - unit automatically resets when count reaches Output 3 or timed output 3 end.

**Manual** - Counter can only be manually reset by a User Input or by Serial Communications command.

### Reset to:

**Zero** - When reset (manually or automatically), counter 2 goes to zero. Output 3 is triggered when counter 2 value reaches Preset 3 Value

**Preset** - When reset (manually or automatically), the Preset 3 Value is loaded into Counter 2. Output 3 is triggered when Counter 2 reaches zero.

### At Timed Output 3 End:

When this mode is selected, Auto Reset occurs when the Output 3 time value elapses and Output 3 deactivates. If not selected, Auto reset occurs when output 3 is triggered.

### Output 3:

**Latched** - When Output 3 activates, it stays activated or latched until it is manually reset.

**Timed** - When Output 3 is activated, it stays activated for the time specified by the Output 3 Time Value. Output 3 deactivates after the Output 3 time duration expires.

The chart below shows operating modes for Counter 2 of the Batch Counter Model.

MODE #	RESET TYPE		RESET			OUTPUT 3	
	Manual	Auto	To Zero	To Preset 3	At Timed 03 End	Latched	Timed
1	√		√			√	
2	√		√				√
3	√			√		√	
4	√			√			√
5		√	√				√
6		√	√		√		√
7		√		√			√
8		√		√	√		√

COUNTER 2 OPERATING MODES (C48CB ONLY)	
1	- Manual Reset to Zero, 03 Latched
2	- Manual Reset to Zero, 03 Timed
3	- Manual Reset to Preset 3, 03 Latched
4	- Manual Reset to Preset 3, 03 Timed
5	- Auto Reset to Zero, 03 Timed
6	- Auto Reset to Zero at 03 Timed Output End
7	- Auto Reset to Preset 3, 03 Timed
8	- Auto Reset to Preset 3 at 03 Timed Output End

Single Preset Model

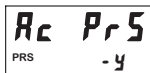

-OR-

Dual Preset Model

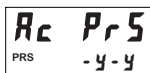

-OR-

Batch Model

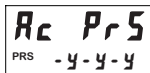

## Access Preset Values

This parameter configures the type of access given to each Preset Value when in normal operating mode with Programming disabled. The accessibility of each Preset can be individually configured. For more information on Program Disable, see Front Panel Accessible Functions With Program Disable, page 14.

### MODE DESCRIPTION

- L **Locked**; Preset is not viewable at main display or in Protected Value Menu. The Preset can only be viewed or changed in the Programming Menu.
- P **Protected Value**; Preset value is viewable and changeable in Protected Value Menu only. It is not viewable at Main Display.
- n **No**; Preset value is viewable only and not changeable from main display when Programming is Disabled. Value is viewable and changeable in the Protected Value Menu.
- y **Yes**; Preset value is viewable and changeable at main display when at 1st level program disable. Value is not shown in Protected Value Menu

### Programming Keys:

- Selects Preset Value being configured as indicated by the number on the left side of the bottom display line.
- Changes mode selection for selected Preset.

*Note: All three available secondary display variations are shown above. Subsequent displays pertaining to outputs will show only the batch version unless otherwise labeled.*

## Preset Values (0-999999)

The Preset Values control the activation of the respective Outputs.

### Preset 1 Value

The Preset 1 Value is used to control Output 1 and is assigned to the main counter (Counter 1 on Batch Model)



Dual Preset/Batch Models



### Preset 2 Value (Dual Preset/Batch Models only)

The Preset 2 Value is used to control Output 2 and is assigned to the main counter (Counter 1 on Batch Model)

### Preset 3 Value (Batch Model only)

The Preset 3 values is used to control Output 3 and is assigned to Counter 2.

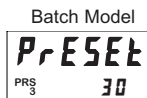

Dual Preset/Batch Models



### Preset 1 Track Preset 2 (Dual Preset/Batch Models only)

This parameter configures whether or not the Preset 1 value tracks or follows the Preset 2 value.

MODE	DESCRIPTION
n0	Preset 1 does not track Preset 2
YES	Preset 1 tracks Preset 2 value. When Preset 2 value is changed the Preset 1 value will change to maintain the same offset. Changing Preset 1 will modify the offset.

Ac Out  
-L-L-L

## Access Output Time Values

This parameter configures the type of access given to each Output Time Value when in normal operating mode with Programming disabled (See Front Panel Accessible Functions With Program Disable, page 14, for more details). The accessibility of each Output Time Value can be individually configured.

MODE	DESCRIPTION
-L	<b>Locked;</b> Output Time Value is not viewable at main display or in Protected Value Menu. The Output Time Value can only be viewed or changed in the Programming Menu.
-P	<b>Protected Value;</b> Output Time Value is viewable and changeable in Protected Value Menu only. It is not viewable at Main Display.
-n	<b>No;</b> Output Time Value is viewable only and not changeable from main display when Programming is Disabled. Value is viewable and changeable in the Protected Value Menu.
-y	<b>Yes;</b> Output Time Value is viewable and changeable at main display when at 1st level program disable. Value is not shown in Protected Value Menu.

### Programming Keys:

- ◀ - Selects Output Time Value being configured as indicated by the number on the left of the bottom display.
- ▲ - Changes mode selection for selected Output Time Value.

OutRES  
0.0 1SEC

## Output Resolution

This parameter configures the timed output resolution for all available Timed Outputs. Use the **0.0 1SEC** resolution if all Output Time Values are below 99.99 seconds.

MODE	DESCRIPTION
0.0 1SEC	0.01 Second Output Resolution; Maximum Output time: 99.99 Seconds
0.1 5EC	0.1 Second Output Resolution; Maximum Output time: 999.9 Seconds

OutPut  
1 t 0.10

## Output 1 Time Value

The Output 1 Time Value controls the Output 1 duration, when Output 1 is set for timed mode of operation (**OPEr** or **OPEr 1** parameter). The Output time value range will be 0.01-99.99 Seconds or 0.1-999.9 seconds, depending on the setting of the Output Resolution (**OutRES**) parameter.

Dual Preset/  
Batch Models

OutPut  
2 t 0.10

## Output 2 Time Value (Dual Preset/ Batch Models only)

The Output 2 Time Value controls the Output 2 duration, when Output 2 is set for timed mode of operation (**OPEr** or **OPEr 1** parameter). The Output time value range will be 0.01-99.99 Seconds or 0.1-999.9 seconds, depending on the setting of the Output Resolution (**OutRES**) parameter.

Batch Model

OutPut  
3 t 0.10

## Output 3 Time Value (Batch Model only)

The Output 3 Time Value controls the Output 3 duration, when Output 3 is set for timed mode of operation (**OPEr 2** parameter). The Output time value range will be 0.01-99.99 Seconds or 0.1-999.9 seconds, depending on the setting of the Output Resolution (**OutRES**) parameter.

ReverseOut  
-n-n-n

## Reverse Output Logic

This parameter individually configures whether or not the Output Logic is reversed, for all Preset Outputs.

MODE	DESCRIPTION
-n	<b>No;</b> Output Logic is not Reversed. Output / Relay will turn ON at Preset Value or Zero (Reset to Preset modes) and turn OFF when Reset or Output Time expires.
-y	<b>Yes;</b> Output Logic is Reversed. Output / Relay will turn OFF at Preset Value or Zero (Reset to Preset modes) and turn ON when Reset or Output Time expires.

### Programming Keys:

 - Selects Output being configured as indicated by the number on the left side of the bottom display line.

 - Selects Output Logic mode for selected Output

**rEURnn**  
- n - n - n



### Reverse Annunciator Logic

This parameter controls the logic state of the Output Annunciators ('01', '02', and '03').

MODE DESCRIPTION

- n **No;** Output Annunciator Logic is not Reversed. Output Annunciator will be ON when the Output is ON.

- y **Yes;** Output Annunciator Logic is Reversed. Output Annunciator will be ON when the Output is OFF.

### Programming Keys:

 - Selects Output Annunciator being configured as indicated by the number on the left side of the bottom display line.

 - Selects Output Annunciator Logic for selected Output

**OutPnP**  
- F - F - F



### Output Power-Up State

This parameter controls the Power-Up State of the Outputs

MODE DESCRIPTION

- F **Off;** The output will be off at power-up.

-  **On;** The output will turn on at power-up.

- P **Previous State;** For latched output modes only. The output will power-up in the state it was in at power-down. For non-latched modes, the output will power-up in the off state.

### Programming Keys:

 - Selects Output being configured as indicated by the number on the left side of the bottom display line.

 - Selects Output Power-up State for selected Output.

## User Inputs

Up to three external User Inputs plus the front panel function key are available on the C48 Counter/Batch Counter. The parameter list below shows all available user input functions. The Input Pull-Up / Pull-down resistor and Active logic level for all the User Inputs (except User Input B) are configured with the Snk/Src jumper (See page 8). For User Input B (*USR Inb*), the Active Logic Level is also configured with the Snk/Src jumper, however the input Pull-Up / Pull-Down resistor is configured by DIP Switch position 4 (Input B 'Snk/Src').

User Input State	Input Voltage Level for Jumper Position		
	Source	Sink*	Count Inhibit (SNK or SRC)
Active	Vin > 3.5 VDC	Vin < 1.5 VDC	Vin < 1.5 VDC
InActive	Vin < 1.5 VDC	Vin > 3.5 VDC	Vin > 3.5 VDC

\* Factory Setting

MODE DESCRIPTION

**StarE** **Store;** When the user input is activated, the main display will 'freeze' and remain frozen until user input is released. On Batch Counter Models, the unit will change to, and freeze the Counter 1/Counter 2 display. See Note 1.

**StarS-L** **Store&Reset (Level Active Reset);** When the user input is activated, the count display will freeze and the internal Counter value (Counter 2 on Batch Model) will reset. The count value will be frozen and internally held reset as long as the user input is held active. On Batch Counter Models, the unit will change to, and freeze the Counter 1/Counter 2 display. See Note 1.

**StarS-E** **Store&Reset (Edge Triggered Reset);** When the user input is activated, the display will freeze and be held until the user input is released. The internal Counter value (Counter 2 on Batch Model) will reset momentarily and then continue to count while input is held active. See Note 1.

**rSt. -L** **Reset (Level Active);** When the user input is activated, the counter (1) value and outputs will be reset and held reset until user input is released.

**rSt. -E** **Reset (Edge Triggered);** When the user input is activated, the counter (1) value and outputs will be momentarily reset and then continue to count and activate while input is held active.

**rSt2-L** **Reset Counter 2 (Level Active) [Batch model Only];** When the user input is activated, the Counter 2 value and outputs will reset and be held reset until user input is released.

MODE	DESCRIPTION
<b>rStZ-E</b>	<b>Reset Counter 2</b> (Edge Triggered) [Batch model Only]; When the user input is activated, the Counter 2 value and outputs will be momentarily reset and then continue to count and activate while input is held active.
<b>rSRL-L</b>	<b>Reset All</b> (Level Active) [Batch model Only]; When the user input is activated, the Counter 1 and Counter 2 values and outputs will reset and be held reset until user input is released.
<b>rSRL-E</b>	<b>Reset All</b> (Edge Triggered) [Batch Counter Only]; When the user input is activated, the Counter 1 and Counter 2 value and outputs will be momentarily reset and then continue to count and activate while input is held active.
<b>ChgD5P</b>	<b>Change Display</b> (edge triggered); When the user input is activated, the secondary display will sequence to the next available value.
<b>Prad.5</b>	<b>Program Disable</b> [level active] (not available for F1 Key); See page 14 for details of Program Disable options.
<b>inh ib</b>	<b>Count Inhibit</b> [level active] (User Input 1 only); When User Input 1 is activated, the Counter(s) will stop counting until User Input 1 is released.
<b>Pr int</b>	<b>Print Request</b> [level active] (RS485 Option only); When the user input is activated, the count, preset, prescaler values, as configured in the Print Options ("PmOPT") parameter will be continually transmitted on the RS485 terminals. See RS485 Serial Communications section.
<b>rStOut</b>	<b>Reset Outputs</b> (Edge Triggered); When the user input is activated, all active outputs will reset to their inactive states. This is a momentary reset.

Note 1: Only one user input may be programmed for a Store (**StorE**) or Store & Reset (**StR5-E** or **StR5-L**) function.

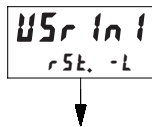

### User Input 1

User Input 1 can be programmed for any of the parameters listed above. Only User Input 1 may be programmed for the Inhibit function.

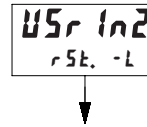

### User Input 2

User Input 2 can be programmed for any of the parameters listed previously except for the Inhibit function. User Input 2 is not available on the Batch Model with relay outputs.

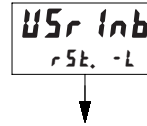

### User Input B

User Input B is available when the Count Input (**Cnt In**) parameter is set to '**C1-USr**' or '**C2-USr**'. This input can be programmed for any of the parameters listed previously except for the Inhibit function.

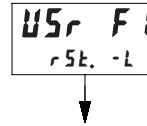

### User F1 Key

User F1 is the front panel function key. This user input can be programmed for any of the parameters listed previously except for the Inhibit and Program Disable functions.

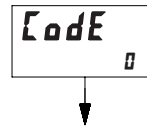

### Programming / Protected Parameter Menu Code Value (0-199)

The Programming Code value can be used to provide Data Value or Programming Menu security. Depending on the Code range selected and the Program Disable Level, it may be necessary to enter the code value before the unit allows access to Programming Menus or Protected Values. See Front Panel Accessible Functions With Program Disable, page 14, for more information.

CODE VALUE	DESCRIPTION
<b>0</b>	Programming is Disabled and Code entry display is not available when Program is Disabled.
<b>1-99</b>	Protected Parameter Menu appears when Code is entered and unit is at 1st level program disable.
<b>100-199</b>	Programming Menu appears when code is entered and unit is at 1st level program disable.

ScRrLL  
no

### Scroll Display

This parameter determines whether or not the secondary display will scroll or sequence automatically to the next available value.

MODE	DESCRIPTION
no	Disables or turns off display scrolling
YEE	Enables display scrolling (2.5 Sec display time)

*Note: The next five parameters pertain to serial communications, and are only available on Dual Preset and Batch Models with the RS485 serial option installed.*

SErSEt  
96n

### Serial Baud Rate and Parity Settings

This parameter configures the Baud Rate and Parity Settings for RS485 Serial Communications.

MODE	DESCRIPTION
12n	1200 Baud; No Parity (8 data bits)
12o	1200 Baud; Odd Parity (7 data bits)
12E	1200 Baud; Even Parity (7 data bits)
24n	2400 Baud; No Parity (8 data bits)
24o	2400 Baud; Odd Parity (7 data bits)
24E	2400 Baud; Even Parity (7 data bits)
48n	4800 Baud; No Parity (8 data bits)
48o	4800 Baud; Odd Parity (7 data bits)
48E	4800 Baud; Even Parity (7 data bits)
96n	9600 Baud; No Parity (8 data bits)
96o	9600 Baud; Odd Parity (7 data bits)
96E	9600 Baud; Even Parity (7 data bits)

SErAdr  
0

### Serial Unit Address (00-99)

This parameter configures the Serial Unit Address. The Address is used to uniquely identify each unit when multiple units are connected on an RS485 bus.

SErAbr  
no

### Serial Abbreviate Mnemonics

When transmitting data, the unit can be programmed to suppress the address number, mnemonics, and some spaces by selecting YEE for this parameter. A selection of YEE results in a faster transmission and may be useful when interfacing with a computer. However, when interfacing with a printer, sending mnemonics is usually desirable.

MODE	DESCRIPTION
no	Unit sends Serial Address, Value Mnemonic, and right justified numeric value when a serial Transmit Value command, Print Request command, or User Input Print Request is issued. A 400 msec "printer delay" is inserted between each value when a Serial Print Request command or User Input Print Request is performed.
YEE	Only the numeric data value is transmitted when a serial Transmit Value command, Print Request command, or User Input Print Request is issued. No unit address, mnemonics, or 400 msec printer delay are transmitted. This option is beneficial when communicating with a computer and faster data throughput is desired.



## Print Options

**PrnOpt**  
3

The Print Options parameter determines which values are printed in response to a Print Request command or user input print request.

MODE NUMBER		PRINT			
Batch Model	Dual Preset Model	Preset Values	Counter (1) Value	Prescaler Value	Counter 2 Value
01	01		√		
02	02	√			
03	03	√	√		
04	04			√	
05	05		√	√	
06	06	√		√	
07	07	√	√	√	
08					√
09			√		√
10		√			√
11		√	√		√
12				√	√
13			√	√	√
14		√		√	√
15		√	√	√	√
Dual Preset Model					
Batch Models					

## Print and Reset Count

**PrnrSt**  
no

This parameter is used in conjunction with Print Request (User Input or Serial Command) and the Print Options to determine whether or not all count values are reset after being acquired for serial transmission.

MODE	DESCRIPTION
no	Do not reset count after Print.
YES	Each Count Value specified in Print Options will reset after being printed (transmitted on Serial) when a Print Request is issued.

## Prescaler Output Pulse at [Prescaler Output Model Only]

**PScORt**  
1 d.9

This parameter selects if the Prescaler Output pulse occurs when the 1's or 10's digit of the Count value changes. See Prescaler Output, page 36, for more details.

MODE	DESCRIPTION
1 d.9	Prescaler Output Pulse activates when 1's digit of counter changes.
10 d.9	Prescaler Output Pulse activates when 10's digit of counter changes.

## Prescaler Output Pulse Length (1-9) [Prescaler Output Model Only]

**PScLEn**  
1

This parameter determines the Prescaler Output Pulse width. The Prescaler Output activates on falling edges of the count signal. Once activated the Prescaler Output Pulse will remain activated for the number of positive count (input) edges specified by the Parameter. See Prescaler Output, page 36, for more details.

**FACTORY SETTINGS**  
no

## Factory Settings

This parameter is used to reset all parameters to their factory defaults. The Factory Settings Chart below shows the settings for each programming parameter.

MODE	DESCRIPTION
no	Do not reset parameters to Factory Settings.
YES	Reset all programming parameters to their Factory Settings.

### FACTORY SETTINGS CHART \*

<b>Entry</b>	NUMERIC VALUE ENTRY METHOD	<u>AutoSc</u>
<b>PRESCALER</b>		
<b>Rc PSc</b>	ACCESS PRESCALER VALUE	<u>-L</u>
<b>PScALr</b>	PRESCALER VALUE	<u>100000</u>
<b>COUNTER</b>		
<b>dEc Pt</b>	DECIMAL POINT POSITION	<u>-----</u>
<b>Cnt In</b>	COUNT MODE	<u>[1-4d</u>
<b>OPEr (1)</b>	COUNTER (1) OPERATING MODE	<u>11</u>
<b>[2 ASn</b>	COUNTER 2 ASSIGNMENT	<u>bAtch</u>
<b>OPEr 2</b>	COUNTER 2 OPERATING MODE	<u>1</u>
<b>PRESETS</b>		
<b>Rc PrS</b>	ACCESS PRESET VALUES	<u>3 2 1</u> <u>-y-y-y</u>
<b>PrESEt</b>	PRESET 1 VALUE	<u>10</u>
<b>PrESEt</b>	PRESET 2 VALUE	<u>20</u>
<b>PrESEt</b>	PRESET 3 VALUE	<u>30</u>
<b>P1trRc</b>	P1 TRACK P2	<u>no</u>

### OUTPUTS

<b>Rc Out</b>	ACCESS OUTPUT TIME VALUES	<u>3 2 1</u> <u>-L-L-L</u>
<b>OutRES</b>	OUTPUT RESOLUTION	<u>0.01SEC</u>
<b>OutPwt</b>	OUTPUT 1 TIME	<u>0.10</u>
<b>OutPwt</b>	OUTPUT 2 TIME	<u>0.10</u>
<b>OutPwt</b>	OUTPUT 3 TIME	<u>0.10</u>
<b>rEUOut</b>	REVERSE RELAY/OUTPUT LOGIC	<u>-n-n-n</u>
<b>rEURnu</b>	REVERSE ANNUNCIATOR LOGIC	<u>-n-n-n</u>
<b>OutP,uP</b>	OUTPUT POWER-UP STATE	<u>-F-F-F</u>

### USER INPUTS

<b>USr In1</b>	USER INPUT 1	<u>rSt, -L</u>
<b>USr In2</b>	USER INPUT 2	<u>rSt, -L</u>
<b>USr Inb</b>	USER INPUT B	<u>rSt, -L</u>
<b>USr F1</b>	USER F1 KEY	<u>rSt, -L</u>

<b>Code</b>	PROGRAMMING CODE VALUE	<u>0</u>
<b>Scroll</b>	SCROLL DISPLAY	<u>no</u>

### RS-485 SERIAL OPTION (DUAL PRESET/BATCH MODELS ONLY)

<b>SErSEt</b>	SERIAL BAUD RATE & PARITY	<u>96n</u>
<b>SErAdr</b>	SERIAL UNIT ADDRESS	<u>0</u>
<b>SErAbr</b>	ABBREVIATE SERIAL MNEMONICS	<u>no</u>
<b>PrnOPt</b>	PRINT OPTIONS	<u>3</u>
<b>PrnrSt</b>	PRINT & RESET COUNT VALUES	<u>no</u>

### PRESCALER OUTPUT MODEL ONLY

<b>PScORt</b>	PRESCALER OUTPUT PULSE AT	<u>1 d.9</u>
<b>PScLEn</b>	PRESCALER OUT PULSE LENGTH	<u>1</u>

\* Settings on the previous page are shown for Dual Preset and Batch models.  
 Changes to Factory Settings for Single Preset Model are as follows:

<b>OPEr</b>	COUNTER OPERATING MODE	5
<b>PrESEt</b>	PRESET 1 VALUE	20

### USER SETTINGS CHART

**Entry** NUMERIC VALUE ENTRY METHOD \_\_\_\_\_

#### PRESCALER

**Rc PSc** ACCESS PRESCALER VALUE \_\_\_\_\_  
**PScALr** PRESCALER VALUE \_\_\_\_\_

#### COUNTER

**dEc Pt** DECIMAL POINT POSITION \_\_\_\_\_  
**Cnt In** COUNT MODE \_\_\_\_\_  
**OPEr (1)** COUNTER (1) OPERATING MODE \_\_\_\_\_  
**C2 ASn** COUNTER 2 ASSIGNMENT \_\_\_\_\_  
**OPEr 2** COUNTER 2 OPERATING MODE \_\_\_\_\_

#### PRESETS

		3	2	1
<b>Rc PrS</b>	ACCESS PRESET VALUES	_____		
<b>PrESEt</b>	PRESET 1 VALUE	_____		
<b>PrESEt</b>	PRESET 2 VALUE	_____		
<b>PrESEt</b>	PRESET 3 VALUE	_____		
<b>P1trRc</b>	P1 TRACK P2	_____		

#### OUTPUTS

		3	2	1
<b>Rc Out</b>	ACCESS OUTPUT TIME VALUES	_____		
<b>OutRES</b>	OUTPUT RESOLUTION	_____		
<b>OutPut</b>	OUTPUT 1 TIME	_____		
<b>OutPut</b>	OUTPUT 2 TIME	_____		
<b>OutPut</b>	OUTPUT 3 TIME	_____		
<b>rEUOut</b>	REVERSE RELAY/OUTPUT LOGIC	_____		
<b>rEUAnn</b>	REVERSE ANNUNCIATOR LOGIC	_____		
<b>OutPwP</b>	OUTPUT POWER-UP STATE	_____		

#### USER INPUTS

**USr In1** USER INPUT 1 \_\_\_\_\_  
**USr In2** USER INPUT 2 \_\_\_\_\_  
**USr Inb** USER INPUT B \_\_\_\_\_  
**USr F1** USER F1 KEY \_\_\_\_\_

**Code** PROGRAMMING CODE VALUE \_\_\_\_\_

**ScroLL** SCROLL DISPLAY \_\_\_\_\_

#### RS-485 SERIAL OPTION (DUAL PRESET/BATCH MODELS ONLY)

**SErSEt** SERIAL BAUD RATE & PARITY \_\_\_\_\_  
**SErAdr** SERIAL UNIT ADDRESS \_\_\_\_\_  
**SErAbbr** ABBREVIATE SERIAL MNEMONICS \_\_\_\_\_  
**PrnOPt** PRINT OPTIONS \_\_\_\_\_  
**PrnrSt** PRINT & RESET COUNT VALUES \_\_\_\_\_

#### PRESCALER OUTPUT MODEL ONLY

**PScORt** PRESCALER OUTPUT PULSE AT \_\_\_\_\_  
**PScLEn** PRESCALER OUT PULSE LENGTH \_\_\_\_\_

## RS-485 SERIAL COMMUNICATIONS

RS-485 communications allows for transmitting and receiving of data over a single pair of wires. This feature can be used for monitoring various values, changing values, and resetting output(s), from a remote location. Typical devices that are connected to a C48C unit are a printer, a terminal, a PLC, an HMI, or a host computer.

PC software (SFC48) allows for easy configuration of unit parameters. These setting can be saved to disk for later use, or used for multi-unit down loading. On-line help is provided within the software.

The RS-485 differential (balanced) design has good noise immunity and allows for communication distances of up to 4000 feet. Up to 32 units can be connected on a pair of wires and a common. The unit's address can be programmed from 00 to 99.

### Communication Format

The half-duplex communication operation sends data by switching voltage levels on the common pair of wires. Data is received by monitoring the levels and interpreting the codes that were transmitted. After the unit receives a Transmit Command or Print Request, it will wait 100 msec before it will begin transmitting data. In order for data to be interpreted correctly, there must be identical formats and baud rates between the communicating devices. The formats available for the C48C unit are 1 start bit, 7 or 8 data bits, No parity or 1 parity bit (odd or even) and 1 stop bit. The available baud rates are 1200, 2400, 4800, or 9600 baud.

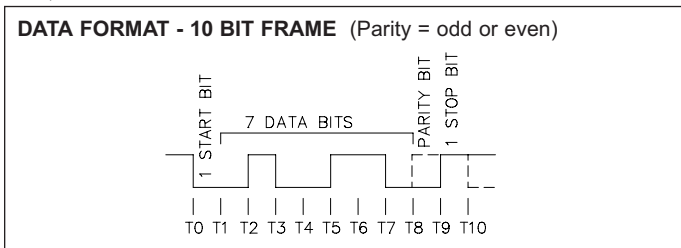

Figure 12, Data Format - 7 Data Bits

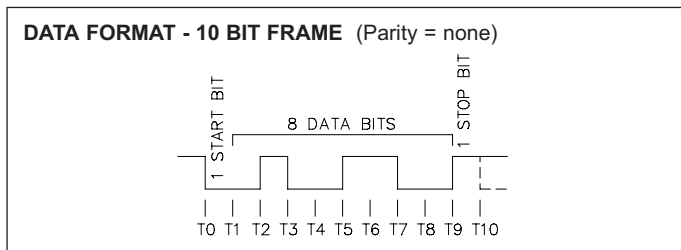

Figure 13, Data Format - 8 Data Bits

Before serial communication can take place, the unit must be programmed to the same baud rate and parity as the connected equipment. In addition, the loop address number and print options should be known. When used with a terminal or host computer and only one unit is employed, an address of zero (00) may be used to eliminate the requirement for the address specifier when sending a command. If more than one unit is on the line, assignment of unique non-zero addresses is recommended.

### Sending Commands and Data

When sending commands to the C48C unit, a command string must be constructed. The command string may consist of command codes, value identifiers, and numerical data. Below is a list of commands and value identifiers that are used when communicating with the C48C unit.

COMMAND	DESCRIPTION
N(4EH)	Unit Address ; Followed by a one or two digit address number 1-99
P (50H)	Transmit Print Options; Transmits the options selected in the Print Options section of the Programming Menu
R (52H)	Reset value; Followed by one value identifier (E, F, 1, 2 or 3)
S (53H)	Set value; Followed by one value identifier (1, 2 or 3)
T (54H)	Transmit value; Followed by one value identifier (A thru F)
V (56H)	Change value; Followed by one value identifier (A thru F) then the proper numerical data

VALUE IDENTIFIERS	MNEMONIC
A (41H) Preset 1	P1
B (42H) Preset 2	P2
C (43H) Preset 3	P3
D (44H) Prescaler	PSC
E (45H) Count 1	CT1
F (46H) Count 2	CT2
1 (31H) Output 1	N/A
2 (32H) Output 2	N/A
3 (33H) Output 3	N/A

*Note: Command identifiers other than those listed should NOT be transmitted. Otherwise, undefined or unpredictable operation could result.*

The command string is constructed by using a command, a value identifier, a data value if required, and the command terminator(\*). The Data value need not contain the decimal point since it is fixed within the C48C, when programmed at the front panel. The unit will accept the decimal point, however, it does not interpret them in any way. Leading zeros can be eliminated, but all trailing zeros must be present.

Example: If a Preset of 1.0000 is to be sent, the data value can be transmitted as 1.0000 or 10000. If a “1” is transmitted, the Preset will be changed to 0.0001.

The Address command is used to allow a command to be directed to a specific unit on the Serial Communications Line. When the unit address is zero, transmission of the Address command is not required. This is done for applications that do not require more than one unit. For applications that require several units, it is recommended that each unit on the line be given a specific non-zero address. If they are given the same address, a command such as the Transmit Value Command, will cause all of the units to respond simultaneously, resulting in a communication collision. All units in a multiple unit application should be given an address other than zero. If a unit has an address of zero, it will attempt to process any transmissions from the other units as commands. These transmissions fill up the receive buffer of the unit with an address of zero, which may produce unpredictable results.

In a multiple unit configuration, an asterisk (2AH) must be sent to clear the input buffer of all units on the line after a transmit value or print request command is sent to a specific unit on the line. The C48C will require a maximum of 50 msec to process the asterisk (\*).

The command string is constructed in a specific logical sequence. The C48C will not accept command strings that do not follow this sequence. Only one operation can be performed per command string. Below is the procedure to be used when constructing a command string.

1. The first two to three characters of the command string must consist of the Address Command (N) and the address number of the unit (1 thru 99). If the C48C address is zero, the address command and number need NOT be sent.
2. The next character in the command string is the actual command that the unit is to perform (P, R, S, T, or V).
3. A Value Identifier is next if it pertains to the command. The print command (P) does not require a Value Identifier.
4. The numerical data will be next in the command string if the Change Value command (V) is used.
5. All command strings must be terminated with an asterisk \* (2AH). This character indicates to the C48C that the command string is complete.

Below are some typical examples of properly constructed command strings.

#### **Examples:**

1. Change Preset 1 Value to 123.4 on the C48C with an address of 2.  
COMMAND STRING: N2VA1234\*
2. Transmit the Count Value of the C48C unit with an address of 3.  
COMMAND STRING: N3TE\*
3. Reset Output 1 of the C48C unit with an address of 0.  
COMMAND STRING: R1\*

If illegal commands or characters are sent to the C48C, the unit will respond by transmitting an error character “E” (45H) in which case the string must be re-transmitted.

When writing application programs in Basic, the transmission of spaces or carriage return and line feed should be inhibited by using the semicolon delimiter with the “PRINT” statement. The C48C will not accept a carriage return or line feed as valid characters. See Terminal Emulation Program, page 33, for a listing of an IBM® PC Basic terminal emulation program.

It is recommended that a “Transmit Value” command follow a “Change Value” Command. If this is done, the reception of the data can provide a timing reference for sending another command and will ensure that the change has occurred. When a “Change Value or Reset Value” command is sent to the C48, there is time required for the unit to process the command string. The diagrams show the timing considerations that need to be made.

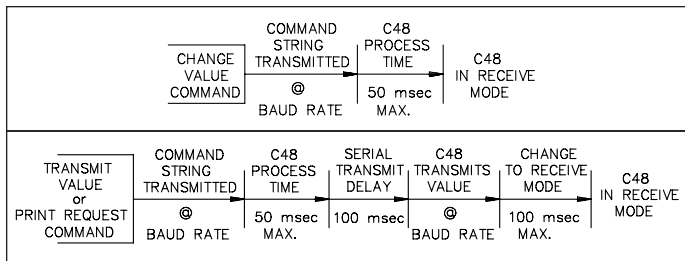

## Receiving Data

Data is transmitted from the C48C when a “T” Transmit Value or a “P” Transmit Print Options command is sent to the unit via the serial port or when a User Input, programmed for the Print Request function, is activated. The C48C will wait a minimum of 100 msec and then begin transmissions. The C48C can also be programmed to transmit mnemonics. The format for a typical transmission string with mnemonics is shown below:

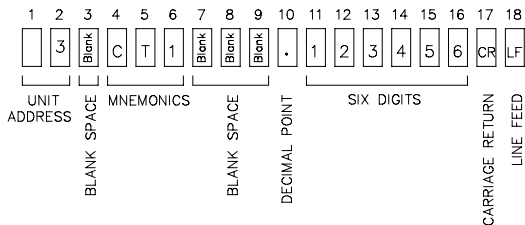

Figure 14, Transmission String

The first two digits transmitted are the unit address followed by one blank space. The next three characters are the mnemonics followed by three or more blank spaces. The numerical data value is transmitted next. The decimal point position will “float” within the data field depending on the actual value it represents. The numeric data is right justified without leading zeros.

When a “T” command or print request is issued, the above character string is sent for each line of a block transmission. An extra <SP><CR><LF> is transmitted following the last line of transmission from a print request, to provide separation between print outs.

If serial is abbreviated (**SErAbr = YES**), just numeric data is sent with no time delay. If the C48C transmits mnemonics, there is a 400 msec built-in time delay after each transmission string when “P” command or a Print Request is issued. When interfacing to a printer, sending mnemonics is usually desirable. Examples of transmissions are shown below:

```
3 P2      6732.5<CR><LF>      Mnemonics Sent
6732.5<CR><LF>                NO Mnemonics Sent
```

The various Print Options are used with a printer or a Computer Terminal. They provide a choice of which C48C data values are to be printed, when either the User Input, programmed for the print request function is activated, or a “P” (Transmit Print Options) command is sent to the C48C via the serial port. See Print Options, page 27, for the available options.

Print outs from a C48C unit with an address of 1 and the following print options are shown below:

DUAL <i>PrnOpt</i> = 7		BATCH <i>PrnOpt</i> = 15	
1	CT1	54	1 CT1 54
1	PSC	1.00000	1 CT2 100
1	P1	4000	1 PSC 1.00000
1	P2	5000	1 P1 4000
			1 P2 5000
			1 P3 6000

## Terminal Emulation Program For IBM® PC

Utilizing the Serial communications capability of the C48C will require the use of an RS485 serial card in the computer. If an IBM® PC compatible is being used, this card would be installed in an expansion slot on the mother-board. The RS485 card should be configured for "2-wire half-duplex" operation. For this mode of operation, each piece of equipment must be able to switch from receive mode to transmit mode and vice-versa. The C48C is normally in the receive mode. It will automatically switch to the transmit mode when a Transmit Value Command is issued or a Print Request is issued. For the computer to switch from receive to transmit mode, the controlling software must be written to perform this task. On most RS485 serial cards, the RTS (Request-to-send) signal can be configured to be used as the direction (transmit/receive) control signal. The controlling software must switch the state of the RTS line when the computer is to switch from transmitting to receiving data.

Listed below is a basic program that will emulate a terminal. It is written using IBM® PC Basic. The program may need to be modified if using a different basic interpreter. Set up the C48C for a baud rate of 9600. When the program is running, commands can be typed in from the keyboard as shown in the previous examples above. An asterisk (\*) is used to end all commands. Do NOT use the carriage return to end a command.

```
1 REM "FOR THIS PROGRAM TO WORK THE "RS485" CARD SHOULD BE
SET-UP AS COM2"
2 REM "ALSO THE CARD SHOULD USE "RTS" FOR HANDSHAKING"
3 REM "THE C48C UNIT SHOULD BE SET-UP FOR 9600 BAUD, AND ODD
PARITY"
4 TXEMPTY = &H60
5 LSR = &H2FD: REM "COMM2 LINE STATUS REGISTER"
6 MCR = &H2FC: REM "COMM2 MODEM CONTROL REGISTER"
10 CLS : CLOSE :
20 OPEN "COM2:9600,0,7,1" FOR RANDOM AS #1
30 ON TIMER(1) GOSUB 300
40 A$ = INKEY$: IF A$ " " THEN GOTO 1000: REM "CHECK FOR KEYBOARD
INPUT"
50 IF LOC(1) = 0 THEN 40 ELSE 80: REM CHECK FOR INPUT
60 IF LOC(1) = 0 THEN 80: REM "SKIP CLEARING OF BUFFER"
70 B$ = INPUT$(LOC(1), #1): REM "CLEAR BUFFER"
80 F = INP (MCR) AND 253: OUT MCR, F: REM "SET FOR RECEIVE MODE"
```

```
90 IF INP(LSR) TXEMPTY THEN 90: REM "WAIT UNTIL DONE
TRANSMITTING"
100 TIMER ON
110 IF LOC(1) = 0 THEN 110
120 B$ = INPUT$(1, #1)
130 IF B$ = CHR$(10) THEN 160" REM "TO PREVENT DOUBLE SPACING ON
PRINT"
140 PRINT B$:
160 IF NOT B$ = " " THEN GOTO 90
170 TIMER OFF
200 GOTO 40
300 TIMER OFF: RETURN 40
1000 D = INP(MCR) OR 2: OUT MCR, D: REM "SET FOR TRANSMIT MODE"
1010 PRINT #1, A$: : PRINT A$: : REM "PRINT KEYSTROKE"
1020 IF A$ = "*" THEN PRINT
1030 IF A$ = "*" THEN IF INP(LSR) TXEMPTY THEN 1030 ELSE GOTO 60
1040 A$ = INKEY$: IF A$ " " THEN GOTO 1000
1050 GOTO 1010
```

## Serial Connections

When wiring, refer to the numbers listed on the label with the terminal description for installing each wire in its proper location.

For RS-485, the data (transceiver) wires connect to the A(+) and B(-) terminals. It is recommended that shielded (screened) cable be used for serial communications. In some applications, a signal ground may be required to establish a ground reference. The signal ground is required if the equipment does not have internal bias resistors connected to the transceiver lines. If necessary, the shield can be used as the signal ground.

## TERMINAL DESCRIPTIONS

COMM. - Common required for communication hook-up.

A (+) & B (-) - The C48C transmits and receives on these two terminals which are connected to the external device.

## CONNECTING TO A HOST TERMINAL

Six C48C units are used to monitor and control parts packaging machines in a plant. C48C units are located at each machine in the production area of the building. A communication line is run to an Industrial computer located in the production office. The drawing shows the line connection. Each C48C is programmed for a

OFFICE COMPUTER  
(WITH RS485 INTERFACE CARD INSTALLED)

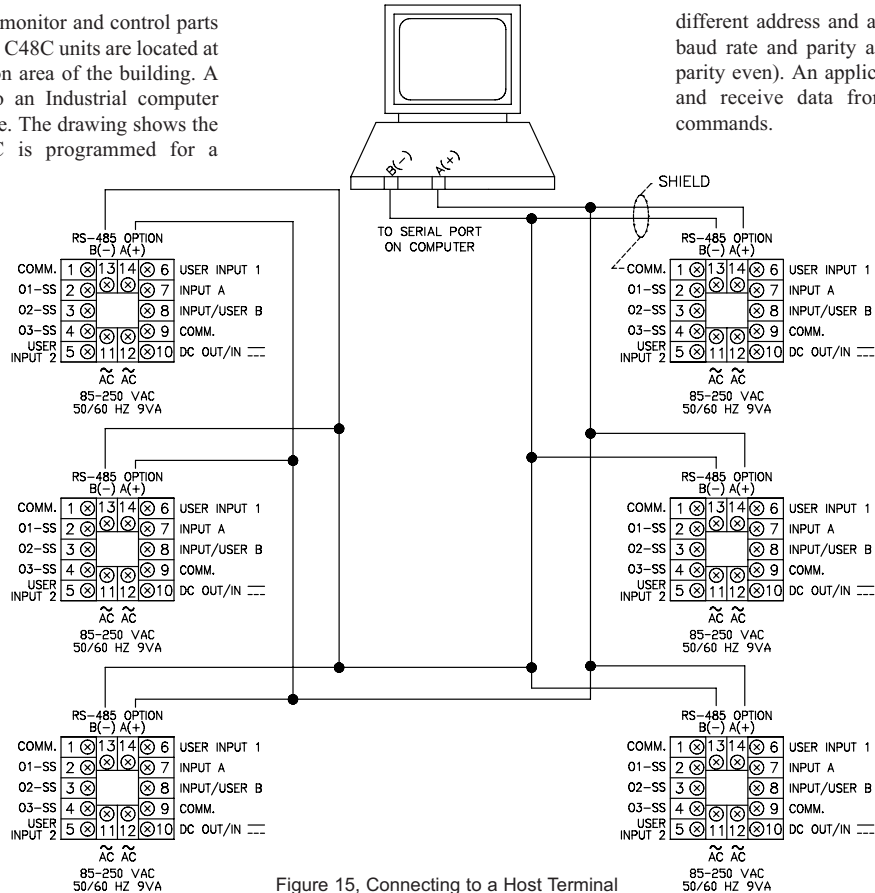

different address and all are programmed for the same baud rate and parity as the computer (ex. 9600 baud, parity even). An application program is written to send and receive data from the units using the proper commands.

Figure 15, Connecting to a Host Terminal



## ***Troubleshooting Serial Communications***

If problems are encountered when interfacing the C48C(s) and host device or printer, the following check list can be used to help find a solution.

1. Check all wiring. Refer to the previous application example and use it as a guide to check your serial communication wiring. Proper polarity of all C48C(s) and other peripherals must be observed.
2. If the C48C is connected to a “host computer”, device or printer, check to make sure that the computer or device is configured with the same communication format as the C48C. The communication format the C48C will accept is; 1 start bit, 7 or 8 data bits, no parity or 1 parity bit (odd or even), and 1 stop bit.
3. Check the baud rate and parity in the Programming Menu **SErSEt** parameter, and make sure all devices on the line are set to the same baud rate and parity.
4. Check the C48C's unit address (**SErAdr**). If the Address command is not used when transmitting a command to the C48C, the C48C's address must be set to 0. See Sending Commands & Data, page 26, for command structure.
5. If two-way communications are to be established between the C48C and a computer, have the computer receive transmissions from the C48C first. Activating a User Input, programmed for the print request function, will initiate transmissions from the C48C.
6. When sending commands to the C48C, an asterisk \* (2AH) must terminate the command. Make sure a carriage return or line feed does not follow the command terminator.
7. In multiple unit configurations, make sure each unit has a different address other than zero. If a transmit value or print request command is issued, an asterisk (\*) must be sent before sending another transmission.
8. If all of the above has been done, try reversing the polarity of the transceiver wires between the C48C(s) and the RS485 interface card. Some cards have the polarity reversed.

## PRESCALER OUTPUT OPTION

The prescaler output is useful for providing a lower frequency scaled pulse train to a PLC or another external totalizing counter. The prescaler output provides programming parameters to determine when to turn the output on (**PScDRt**) [display dependent] and when to turn the output off (**PScLEn**) [input pulse dependent].

The prescaler output turns on when the LSD (least significant digit) of the display value changes by one digit (**1 d.9**), or when the 2nd LSD changes by one digit, effectively a display change of 10 (**10 d.9**).

The (**PScLEn**) is the turnoff point of the prescaler output after the programmed number of positive edge input pulses (1 through 9).

*Note: The activation of the prescaler output is dependent on the display value change. The deactivation of the prescaler output is dependent on the positive edge of the input pulse, and NOT display value change.*

During manual reset of the counter, an activated prescaler output is reset (turned off).

The optimum prescaler length value for a specific prescaler value and prescaler output at (**PScDRt**) setting can be obtained from the tables at right. Where possible, the optimum value will provide a duty cycle close to 50%.

For <b>PScDRt</b> = <b>1 d.9</b>	
PRESCALER VALUE <b>PScALr</b>	OUTPUT LENGTH VALUE <b>PScLEn</b>
0.50001-1.00000	1
0.25001-0.50000	2
0.17001-0.25000	3
0.12501-0.17000	4
0.10001-0.12500	5
0.08251-0.10000	6
0.07001-0.08250	7
0.06251-0.07000	8
0.00001-0.06250	9

For <b>PScDRt</b> = <b>10 d.9</b>	
PRESCALER VALUE <b>PScALr</b>	OUTPUT LENGTH VALUE <b>PScLEn</b>
0.82501-1.00000	6
0.70001-0.82500	7
0.62501-0.70000	8
0.00001-0.62500	9

When **PScLEn** value is obtained from the tables:

$$\text{Effective Prescaler Output Frequency} = \frac{\text{Application's Max. Input Frequency}}{2 \times (\text{PScLEn} - 0.5)}$$

As a rule, the counter connected to the prescaler output should be able to accept a count rate at or higher than the "Effective Prescaler Output Frequency".

**Example:** A manufacturer needs to measure the flow of a liquid to their process in tenths of a gallon. They also require a signal to their PLC to register the total number of gallons used. The flow meter outputs 50 pulses per gallon. Using the programming parameters set as described at right, the prescaler output provides one output pulse for every 50 input signal pulses, or 1.0 display value change.

**PScALr = 020000** (Display will change 0.1 gallons for every 5 input signal pulses)  
**PScDRt = 10 d.9** (Prescaler output will turn on as the 2nd LSD changes by one digit, or when the display changes to every whole gallon.)  
**PScLEn = 9** (Prescaler output turns off 9 input pulses after turn on. Effectively 0.2 gallons after each whole gallon.)

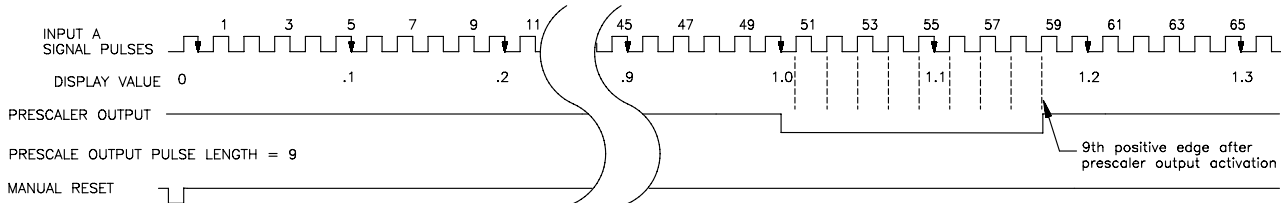

## APPENDIX "A" - APPLICATION EXAMPLE

### Slow Down & Cut to Length with Total Yardage

To improve production efficiency, a wallpaper manufacturing plant is installing cut to length counters on the roll form machines. Currently, electro-mechanical counters are used for length measurements. The operator slows the machine down upon arriving at the desired length, stops and then cuts. The addition of the C48CB batch counters eliminates the operator's manual observation and control.

The operator programs the required cut length as Preset 2. Preset 1 is preprogrammed for tracking and will automatically follow Preset 2. Preset 1 is used as the slow down, and is set for a value 0.25 yards less than Preset 2. The process count is programmed to automatically reset at the Preset 2 cut length of 11.00 yards, and begin counting for the next roll. Counter 2 is programmed as a totalizer and is recorded and reset (via key switch)

at the end of the operator's shift. The C48CB was ordered with the RS-485 serial communication option. Future plans include a data acquisition program to interrogate the C48CB's. A 100 ppr rotary pulse generator is shaft coupled to a 4" pinch roller for length measurement. Display units desired is 0.01 yards. Program Security features are set to allow access to Preset 2 only. This allows the operator to change the required cut length, but prevents accidental changes to other programming parameters that may adversely affect process operation. After all programming is complete, the Program Disable DIP switch is moved to the up position to enable the Program Security function.

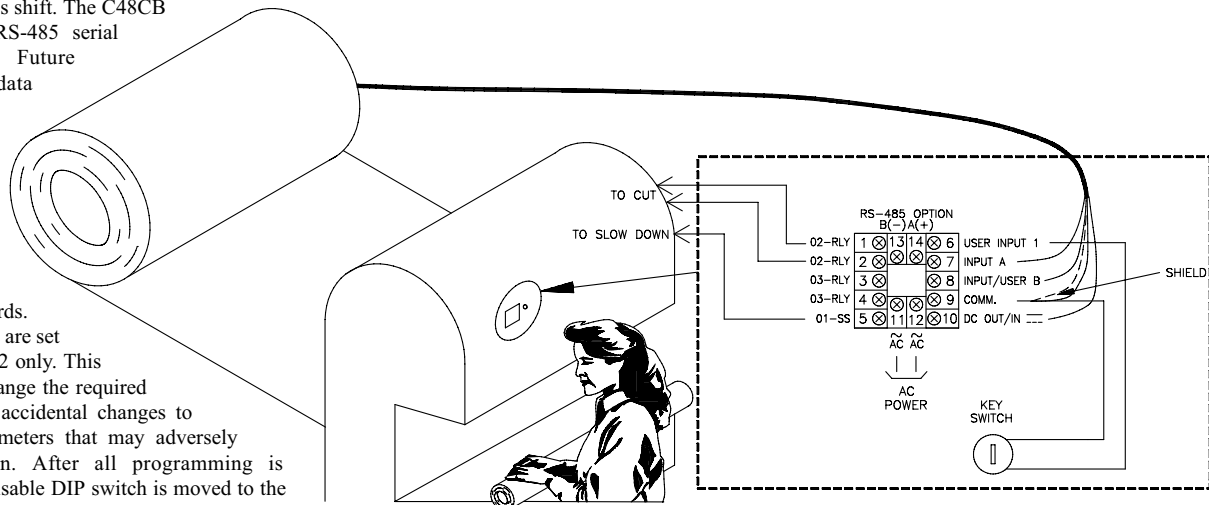

#### Circumference of pinch roller:

$$\text{circumference} = \pi \times \text{diameter}$$

$$12.56636 = 3.14159 \times 4.00$$

#### Pulses per yard:

$$\frac{36 \text{ inches}}{1 \text{ yard}} \times \frac{1 \text{ rev}}{12.56636} = 2.8647913 \text{ rev/yard}$$

#### Prescaler:

$$\text{Prescaler} = \frac{\text{Display Units}}{\text{number of pulses}}$$

$$\text{Prescaler} = \frac{100}{286.47913}$$

$$\text{Prescaler} = 0.34907$$

## APPLICATION PROGRAMMING

```
EntErY      RuLoSc
Ac PSc      -L (locked)
PScALr      034907
dEc Pk      ----
Ent In      QUAd 1
OPEr 1      12
C2 RSn      kOkAL
OPEr 2      02
Ac PrS      -L-Y-L
PrESEt      PRS1 10.75 (value 0.25 less than PRS2 for slow down)
PrESEt      PRS2 1000 (cut length)
PrESEt      PRS3 900000 (set high so output does not activate)
PtkRAc      YES
Ac Out      -L-L-L
OutRES      0015EC
OutPuk 1t   0.10
OutPuk 2t   100
OutPuk 3t   0.10
rEUOut      -n-n-n
rEURnu      -n-n-n
OutPwP      -F-F-F
USr In 1    rSk2-E
USr F 1     rSk-E
CodE        003
ScroLL      no
SErSEt      960
SErAdr      00
SErRbr      no
PrnOPk      00
PrnrSk      no
FRcSEt      no
```

## APPENDIX “B” - SPECIFICATIONS AND DIMENSIONS

1. **DISPLAY:** 2 Line by 6 digit LCD display. Positive image reflective or negative image transmissive with red (top line) and green (bottom line) backlighting

**Main Display:** 0.3” (7.62 mm) high digits

**Secondary Display:** 0.2” (5.08 mm) high digits

**Annunciators:**

**Value:** PRS, 1, 2, and 3

**Output:** 01, 02, and 03.

2. **POWER REQUIREMENTS:**

**AC Versions (C48CXX0X):**

**AC Power:** 85 to 250 VAC, 50/60 Hz, 9 VA max.

**DC Power:** 11 to 14 VDC @ 150 mA max. (Non PNP output models)

*Note: AC Versions with PNP outputs cannot be powered from DC.*

**DC Versions (C48CXX1X):**

**CONTINUOUS:**

**DC Power:** 18 to 36 VDC; 5.5 W max.

**AC Power:** 24 VAC  $\pm 10\%$ ; 50/60 Hz; 7 VA max.

*Note: The +10% tolerance range on AC input voltage must be strictly adhered to. DO NOT EXCEED 26.4 VAC.*

**PEAK (START-UP CURRENT):**

**AC or DC Power:** 500 mA peak start-up current for 10 msec max.

3. **MEMORY:** Nonvolatile E<sup>2</sup>PROM retains all programmable parameters and count values.

4. **SENSOR POWER:** +12 VDC ( $\pm 15\%$ ) @ 100 mA max.

5. **COUNT INPUTS A & B:** Accepts count pulses from a variety of sources, DIP switch selectable.

**Current Sourcing:** 3.9K $\Omega$  pull-down,  $V_{IN}$  max = 30 VDC

**Current Sinking:** 7.8K $\Omega$  pull-up to 12 VDC;  $I_{SNK}$  = 1.8 mA max.

**Debounce:** 50 Hz max.

**Lo Bias:**  $V_{IL}$  = 1.5 VDC max.,  $V_{IH}$  = 3.75 VDC min.

**Hi Bias:**  $V_{IL}$  = 5.5 VDC max.,  $V_{IH}$  = 7.5 VDC min.

6. **USER INPUTS:** Configurable as current sinking (active low) or current sourcing (active high) inputs via a single plug jumper.

**Current Sinking:**  $V_{IL}$  = 1.5 VDC max, 22 K $\Omega$  pull-up to 5 VDC.

**Current Sourcing:**  $V_{IH}$  = 3.5 VDC min.,  $V_{IN}$  max = 30 VDC; 22 K $\Omega$  pull-down.

**Response Time** = 10 msec max.

**Inhibit Response Time** = 250  $\mu$ sec max.

### DIMENSIONS In inches (mm)

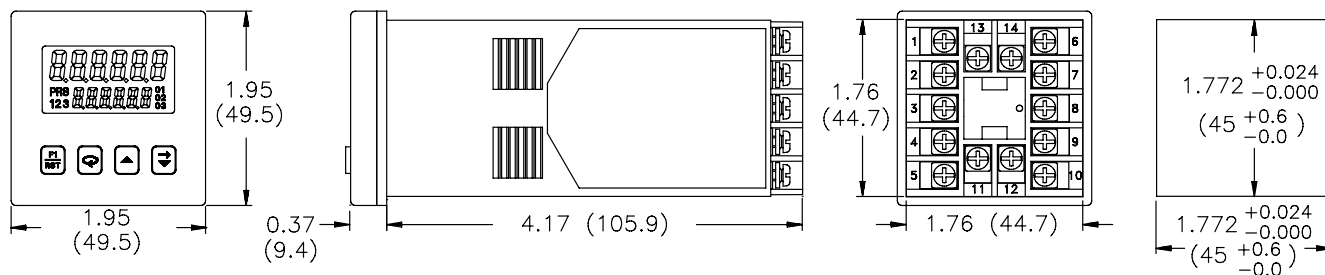

7. **MAX. COUNT RATE:** Model dependent. All listed values are in KHz.

**Single Preset Model C48CS**

PRESCALER VALUE	C1-Usr C1-Ud	C2-Usr C2-Ud	* Ad-Sub Ad-Ad	QUAD		
				X1	X2	X4
0.00001-0.99999	8.4	4.1	9.4	5.1	4.5	2.1
1.00000	12	5.9	12.4	5.8	6	3
1.00001-2	6.6	3.2	6.8	4.3	3.3	1.6
2.00001-3	5.3	2.6	5.6	3.7	2.6	1.3
3.00001-4	4.3	2.1	4.6	3	2.2	1.1
4.00001-5	3.6	1.8	3.8	2.7	1.8	0.9
5.00001-6	3.1	1.5	3.4	2.4	1.6	0.8
6.00001-7	2.8	1.4	3.2	2.1	1.4	0.7
7.00001-8	2.6	1.3	2.8	1.9	1.3	0.6
8.00001-9	2.3	1.1	2.4	1.8	1.1	0.5
9.00001-9.99999	2.1	1	2.3	1.7	1.1	0.5

**Dual Preset Model C48CD**

PRESCALER VALUE	C1-Usr C1-Ud	C2-Usr C2-Ud	* Ad-Sub Ad-Ad	QUAD		
				X1	X2	X4
0.00001-0.99999	8.3	4.1	8.6	4.5	4.1	2.1
1.00000	11.5	5.7	11.5	6	5.8	3
1.00001-2	6.5	3.2	6.6	4	3.2	1.6
2.00001-3	5	2.4	5.2	3.4	2.5	1.3
3.00001-4	4.1	2	4.4	2.8	2	1
4.00001-5	3.4	1.7	3.8	2.5	1.7	0.8
5.00001-6	2.9	1.4	3.2	2.2	1.4	0.7
6.00001-7	2.7	1.3	2.8	2	1.3	0.6
7.00001-8	2.2	1.1	2.4	1.8	1.2	0.6
8.00001-9	2.2	0.9	2.3	1.6	1.1	0.5
9.00001-9.99999	1.9	0.9	2	1.5	0.9	0.4

**Batch Model C48CB:**

With Counter 2 configured as a Batch Counter ( $\Sigma 2 \text{ } R5n = \text{batch}$ )

PRESCALER VALUE	C1-Usr C1-Ud	C2-Usr C2-Ud	* Ad-Sub Ad-Ad	QUAD		
				X1	X2	X4
0.00001-0.99999	8.3	4.1	8.4	3.35	3.6	2.2
1.00000	11.4	5.5	11.8	3.87	4.2	3
1.00001-2	6.5	3.2	6.6	3.2	3	1.6
2.00001-3	5	2.5	5.4	2.8	2.5	1.3
3.00001-4	4.1	2	4.2	2.4	2	1
4.00001-5	3.4	1.7	3.8	2.1	1.7	0.8
5.00001-6	2.9	1.4	3.2	1.9	1.5	0.7
6.00001-7	2.7	1.3	2.8	1.7	1.3	0.6
7.00001-8	2.4	1.1	2.6	1.6	1.2	0.6
8.00001-9	2.2	1.1	2.4	1.5	1.1	0.5
9.00001-9.99999	1.9	0.9	2.2	1.4	1	0.4

**Batch Model C48CB:**

With Counter 2 configured as a Total Counter ( $\Sigma 2 \text{ } R5n = \text{total}$ )

PRESCALER VALUE	C1-Usr C1-Ud	C2-Usr C2-Ud	* Ad-Sub Ad-Ad	QUAD		
				X1	X2	X4
0.00001-0.99999	6.5	3.3	6.6	3.5	3.3	1.6
1.00000	8.5	3.6	8.6	3.8	4	2.1

**Prescaler Output Model C48CP**

PRESCALER VALUE	C1-Usr C1-Ud	C2-Usr C2-Ud	* Ad-Sub Ad-Ad	QUAD		
				X1	X2	X4
0.00001-0.99999	6	N/A	N/A	N/A	N/A	N/A
1.00000	8	N/A	N/A	N/A	N/A	N/A

*Note 1: Maximum count rates for X2 & X4 modes are given for 50 % duty cycle signals and quad signals with 90° phase shift.*

*\* - Inputs A & B rates summed.*

## 8. OUTPUTS: (Output type and quantity, model dependent)

### Solid-State:

**NPN Open Collector:**  $I_{SNK} = 100$  mA max. @  $V_{OL} = 1.1$  VDC max.;  
 $V_{OH} = 30$  VDC max.

**PNP Open Collector:**  $I_{SRC} = 100$  mA max.(See note);  
 $V_{OH} = 12$  VDC  $\pm 15\%$  (using internal supply);  $V_{OH} = 13$  to 30 VDC  
(using external supply).

*Note: The internal supply of the C48C can provide a total of 100 mA for the combination of sensor current and PNP output sourcing current. The supply voltage is +12 VDC ( $\pm 15\%$ ), which will be the PNP output voltage level when using only the internal supply.*

*If additional PNP output sourcing current or a higher output voltage level is desired, an external DC supply may be connected between the "DC Out/In" and "Comm." terminals. This supply will determine the PNP output voltage level, and must be in the range of +13 to +30 VDC.*

*An external supply can provide the additional output sourcing current required in applications where two or more outputs are "ON" simultaneously. However, the maximum rating of 100 mA per individual output must not be exceeded, regardless of external supply capacity.*

**Relay:** Form A contact, Rating = 5 A @ 250 VAC, 30 VDC (resistive load),  
1/10 HP @ 120 VAC (inductive load)

**Relay Life Expectancy:** 100,000 cycles min. at max. load rating

**Programmable Timed Output:** User selectable output time resolution.

**0.01 Second Resolution:** 0.01 to 99.99 sec,  $\pm 0.01\%$  +20 msec max.  
(Prescalers less than 2)

**0.1 Second Resolution:** 0.1 to 999.9 sec,  $\pm 100$  msec  
(Prescalers less than 2)

*Note: For Prescaler values above 2, the timed delay output is affected by the count speed (rate).*

## 9. RS485 SERIAL COMMUNICATIONS (Optional): Up to 32 units can be connected.

**Baud Rate:** Programmable from 1200 to 9600 baud

**Address:** Programmable from 0 to 99

**Data Format:** 10 Bit Frame, 1 start bit, 7 or 8 data bits, 1 or No Parity bit,  
and 1 stop bit

**Parity:** Programmable for Odd (7 data bits), Even (7 data bits), or None (8  
data bits)

## 10. CERTIFICATIONS AND COMPLIANCES:

### SAFETY

UL Recognized Component, File #E137808, UL508, CSA C22.2 No. 14  
Recognized to U.S. and Canadian requirements under the Component  
Recognition Program of Underwriters Laboratories, Inc.  
Type 4X Indoor Enclosure rating (Face only), UL50  
IEC 1010-1, EN 61010-1: Safety requirements for electrical equipment for  
measurement, control, and laboratory use, Part 1.  
IP65 Enclosure rating (Face only), IEC 529

### ELECTROMAGNETIC COMPATIBILITY

#### Immunity to EN 50082-2

Electrostatic discharge	EN 61000-4-2	Level 2; 4 Kv contact Level 3; 8 Kv air
Electromagnetic RF fields	EN 61000-4-3	Level 3; 10 V/m 80 MHz - 1 GHz
Fast transients (burst)	EN 61000-4-4	Level 4; 2 Kv I/O Level 3; 2 Kv power
RF conducted interference	EN 61000-4-6	Level 3; 10 V/rms 150 KHz - 80 MHz
Simulation of cordless telephone	ENV 50204	Level 3; 10 V/m 900 MHz $\pm 5$ MHz 200 Hz, 50% duty cycle

#### Emissions to EN 50081-2

RF interference	EN 55011	Enclosure class A
-----------------	----------	-------------------

*Notes:*

#### AC VERSIONS

1. A power line filter, RLC#LFIL0000 or equivalent, was installed when the unit was DC powered.

#### DC VERSIONS

*To insure compliance with the EMC standards listed above, do not connect any wires from the terminal(s) labeled "COMM." to the "DC-" supply terminal (12), when powering the unit from a DC supply.*



*Refer to EMC Installation Guidelines section of the manual for additional information.*

11. **ELECTRICAL CONNECTIONS:** Wire clamping screw terminals.
12. **CONSTRUCTION:** Black plastic case with collar style panel latch. The panel latch can be installed for horizontal or vertical stacking. Black plastic textured bezel with clear display viewing window. Unit assembly with circuit boards can be removed from the case without removing the case from the panel or disconnecting the wiring. This unit is rated for NEMA 4X/IP65 indoor use. Installation Category II, Pollution Degree 2.
13. **ENVIRONMENTAL CONDITIONS:**  
**Operating Temperature:** 0°C to 50°C  
**Storage Temperature:** -40°C to 70°C  
**Operating and Storage Humidity:** 85% max. relative humidity (non-condensing) from 0°C to 50°C.  
**Altitude:** Up to 2000 meters
14. **WEIGHT:** 6.0 oz (170 g)



## APPENDIX “C” - TROUBLESHOOTING

The majority of problems can be traced to improper connections or incorrect set-up parameters. Be sure all connections are clean and tight, that the correct output board is fitted, and that the set-up parameters are correct. Also, be sure the DIP switch settings and the User Input Plug Jumper position are correct for the particular application. For further technical assistance, contact technical support at the numbers listed on the back cover of this instruction manual.

PROBLEMS	POSSIBLE CAUSE	REMEDIES
NO DISPLAY	<ol style="list-style-type: none"> <li>1. Power off.</li> <li>2. Loose connection or improperly wired.</li> <li>3. Brown out condition.</li> <li>4. Bezel assembly not fully seated into rear of unit.</li> <li>5. If powered by +12 VDC source, not enough current to drive C48.</li> </ol>	<ol style="list-style-type: none"> <li>1. Verify power.</li> <li>2. Check connections and wiring.</li> <li>3. Verify power reading.</li> <li>4. Check installation.</li> <li>5. Verify Source current rating.</li> </ol>
<b>Err 1</b> DISPLAYED AT POWER UP	<ol style="list-style-type: none"> <li>1. Data error in count values detected by processor.</li> </ol>	<ol style="list-style-type: none"> <li>1. Press  key.</li> <li>2. Check signal lines for possible noise sources.</li> </ol>
<b>Err 2</b> DISPLAYED AT POWER UP	<ol style="list-style-type: none"> <li>1. Data error in preset, prescaler, or output time values detected by processor.</li> </ol>	<ol style="list-style-type: none"> <li>1. Press  key.               <ol style="list-style-type: none"> <li>a. Check presets, prescaler, and output time values.</li> </ol> </li> <li>2. Check signal lines for possible noise sources.</li> </ol>
<b>Err 3</b> DISPLAYED AT POWER UP	<ol style="list-style-type: none"> <li>1. Data error in programming parameters detected by processor.</li> </ol>	<ol style="list-style-type: none"> <li>1. Press  key.               <ol style="list-style-type: none"> <li>a. Check all programming parameters.</li> </ol> </li> <li>2. Check signal lines for possible noise sources.</li> </ol>
UNIT DOES NOT COUNT	<ol style="list-style-type: none"> <li>1. No input signal.</li> <li>2. Type of input signal incorrectly selected.</li> <li>3. Count inhibited.</li> <li>4. Prescaler value too small.</li> </ol>	<ol style="list-style-type: none"> <li>1. Check sensor connections.               <ol style="list-style-type: none"> <li>a. Verify power to sensor.</li> </ol> </li> <li>2. Check DIP switch settings.</li> <li>3. Disable count inhibit.</li> <li>4. Check prescaler value.</li> </ol>
UNIT COUNTS INCORRECTLY	<ol style="list-style-type: none"> <li>1. Input signal type incorrectly selected.</li> <li>2. Inputs improperly connected.</li> <li>3. Electrical noise interference.</li> <li>4. Incorrect counting mode.</li> <li>5. Prescaler incorrect.</li> </ol>	<ol style="list-style-type: none"> <li>1. Check DIP switches. Set HI/LO FRQ. switch to LO for count speed of less than 50 Hz.</li> <li>2. Check sensor input connections.</li> <li>3. Check power source for noise.               <ol style="list-style-type: none"> <li>a. Check signal wire routing.</li> </ol> </li> <li>4. Verify count input mode.</li> <li>5. Verify prescaler.</li> </ol>

## **APPENDIX “C” - TROUBLESHOOTING (Cont’d)**

<b>PROBLEMS</b>	<b>POSSIBLE CAUSE</b>	<b>REMEDIES</b>
CAN NOT ENTER INTO PROGRAMMING	1. Front panel disabled.	1. Check “Front Panel Accessible Functions With Program Disable” section of the manual.
PROCESS, BATCH, OR TOTAL VALUES WILL NOT RESET WHEN A MANUAL RESET IS PERFORMED	1. User input not properly programmed. 2. User Input Snk/Src jumper configured improperly.	1. Verify programming of User Input parameter. 2. Configure Snk/Src jumper.
PRESCALER, PRESETS, OR OUTPUT TIME VALUES CAN BE VIEWED BUT NOT CHANGED	1. Front panel disabled.	1. Verify programming of Access parameters. 2. Check “Front Panel Accessible Functions With Program Disable” section of manual.
UNIT COUNTS WHILE RESET IS ACTIVATED	1. User input reset mode set for momentary reset.	1. Program User input to a maintained reset.
OUTPUT WILL NOT RESET	1. User input not properly programmed.	1. Verify programming of the user input parameter.
OUTPUTS NOT WORKING	1. Output board not installed. 2. Improperly wired. 3. Incorrect output board. 4. Defective output board.	1. Install output board. 2. Check wiring. 3. Check output board. 4. Check or replace output board.

## APPENDIX “D” - CALCULATING THE PRESCALER

The C48C is factory set to provide one count on the display for each pulse that is input to the unit. In many applications, there will not be a one to one correspondence between input pulses and desired display units. In these applications, it will be necessary for the C48C to scale or multiply the input pulses by a prescaler to achieve the proper display units desired (feet, meters, gallons, etc.).

The first step in determining the prescaler is to obtain the Number of Pulses per Display Unit. This may require a small amount of deductive reasoning.

**Example:** A 48-tooth gear is mounted to a 2 ft circumference feed roll in a paper processing plant. It is desired to display the footage of paper processed per day. In this example, the display units are in feet. A sensor sensing the gear teeth provides 48 pulses for each revolution of the feed roll. Each revolution equates to a linear distance of 2 feet. The number of Display Units desired is 2. The Number of Pulses per Display Units is 48. When the number of Display Units and the Number of Pulses have been obtained, the prescaler can be calculated.

The Prescaler is obtained by dividing the Display Units by the Number of Pulses as shown in the Formula below.

$$\text{Prescaler} = \frac{\text{Display Units} \times \text{Display Decimal Point}}{\text{Number of Pulses}}$$

For the preceding example, the prescaler is calculated by plugging 2 and 48 into the formula:

**WHERE:**

**Display Units** = The number of desired units (revolutions, feet, 10ths of feet, meters, etc.) that would be acquired after the Number of Pulses has occurred.

**Number of Pulses** = The number of pulses required to achieve the number of Display Units.

**Display Decimal Point** = The desired Display Decimal Point position.

<u>Desired Decimal Point</u>	<u>Enter In Formula</u>
0	1
0.0	10
0.00	100
0.000	1000
0.0000	10000
0.00000	100000

$$\text{Prescaler} = \frac{2}{48}$$

$$\text{Prescaler} = 0.041667$$

# APPENDIX "E" - TERMINAL CONFIGURATIONS FOR C48 COUNTERS

## C48CXX0X VERSIONS (85 to 250 VAC POWERED)



**CAUTION:** Observe proper polarity when connecting DC voltages. Damage to the unit will occur if polarity is reversed.

<p><b>C48CS - SINGLE PRESET RELAY AND SOLID-STATE OUTPUTS</b></p> <p>RS-485 OPTION B(-)A(+)</p> <table border="1"> <tr> <td>COMM.</td> <td>1 ⊗</td> <td>13 ⊗</td> <td>14 ⊗</td> <td>6 ⊗</td> <td>USER INPUT 1</td> </tr> <tr> <td>O1-SS</td> <td>2 ⊗</td> <td>⊗</td> <td>⊗</td> <td>7 ⊗</td> <td>INPUT A</td> </tr> <tr> <td>O1-RLY</td> <td>3 ⊗</td> <td></td> <td></td> <td>8 ⊗</td> <td>INPUT/USER B</td> </tr> <tr> <td>O1-RLY</td> <td>4 ⊗</td> <td>⊗</td> <td>⊗</td> <td>9 ⊗</td> <td>COMM.</td> </tr> <tr> <td>USER INPUT 2</td> <td>5 ⊗</td> <td>11 ⊗</td> <td>12 ⊗</td> <td>10 ⊗</td> <td>DC OUT/IN <math>\equiv</math></td> </tr> </table> <p style="text-align: center;">~ AC ~ AC</p>	COMM.	1 ⊗	13 ⊗	14 ⊗	6 ⊗	USER INPUT 1	O1-SS	2 ⊗	⊗	⊗	7 ⊗	INPUT A	O1-RLY	3 ⊗			8 ⊗	INPUT/USER B	O1-RLY	4 ⊗	⊗	⊗	9 ⊗	COMM.	USER INPUT 2	5 ⊗	11 ⊗	12 ⊗	10 ⊗	DC OUT/IN $\equiv$	<p><b>C48CD - DUAL PRESET RELAY OUTPUTS</b></p> <p>RS-485 OPTION B(-)A(+)</p> <table border="1"> <tr> <td>O2-RLY</td> <td>1 ⊗</td> <td>13 ⊗</td> <td>14 ⊗</td> <td>6 ⊗</td> <td>USER INPUT 1</td> </tr> <tr> <td>O2-RLY</td> <td>2 ⊗</td> <td>⊗</td> <td>⊗</td> <td>7 ⊗</td> <td>INPUT A</td> </tr> <tr> <td>O1-RLY</td> <td>3 ⊗</td> <td></td> <td></td> <td>8 ⊗</td> <td>INPUT/USER B</td> </tr> <tr> <td>O1-RLY</td> <td>4 ⊗</td> <td>⊗</td> <td>⊗</td> <td>9 ⊗</td> <td>COMM.</td> </tr> <tr> <td>USER INPUT 2</td> <td>5 ⊗</td> <td>11 ⊗</td> <td>12 ⊗</td> <td>10 ⊗</td> <td>DC OUT/IN <math>\equiv</math></td> </tr> </table> <p style="text-align: center;">~ AC ~ AC</p>	O2-RLY	1 ⊗	13 ⊗	14 ⊗	6 ⊗	USER INPUT 1	O2-RLY	2 ⊗	⊗	⊗	7 ⊗	INPUT A	O1-RLY	3 ⊗			8 ⊗	INPUT/USER B	O1-RLY	4 ⊗	⊗	⊗	9 ⊗	COMM.	USER INPUT 2	5 ⊗	11 ⊗	12 ⊗	10 ⊗	DC OUT/IN $\equiv$	<p><b>C48CD - DUAL PRESET SOLID-STATE OUTPUTS</b></p> <p>RS-485 OPTION B(-)A(+)</p> <table border="1"> <tr> <td>COMM.</td> <td>1 ⊗</td> <td>13 ⊗</td> <td>14 ⊗</td> <td>6 ⊗</td> <td>USER INPUT 1</td> </tr> <tr> <td>O1-SS</td> <td>2 ⊗</td> <td>⊗</td> <td>⊗</td> <td>7 ⊗</td> <td>INPUT A</td> </tr> <tr> <td>O2-SS</td> <td>3 ⊗</td> <td></td> <td></td> <td>8 ⊗</td> <td>INPUT/USER B</td> </tr> <tr> <td>N/C</td> <td>4 ⊗</td> <td>⊗</td> <td>⊗</td> <td>9 ⊗</td> <td>COMM.</td> </tr> <tr> <td>USER INPUT 2</td> <td>5 ⊗</td> <td>11 ⊗</td> <td>12 ⊗</td> <td>10 ⊗</td> <td>DC OUT/IN <math>\equiv</math></td> </tr> </table> <p style="text-align: center;">~ AC ~ AC</p>	COMM.	1 ⊗	13 ⊗	14 ⊗	6 ⊗	USER INPUT 1	O1-SS	2 ⊗	⊗	⊗	7 ⊗	INPUT A	O2-SS	3 ⊗			8 ⊗	INPUT/USER B	N/C	4 ⊗	⊗	⊗	9 ⊗	COMM.	USER INPUT 2	5 ⊗	11 ⊗	12 ⊗	10 ⊗	DC OUT/IN $\equiv$
COMM.	1 ⊗	13 ⊗	14 ⊗	6 ⊗	USER INPUT 1																																																																																							
O1-SS	2 ⊗	⊗	⊗	7 ⊗	INPUT A																																																																																							
O1-RLY	3 ⊗			8 ⊗	INPUT/USER B																																																																																							
O1-RLY	4 ⊗	⊗	⊗	9 ⊗	COMM.																																																																																							
USER INPUT 2	5 ⊗	11 ⊗	12 ⊗	10 ⊗	DC OUT/IN $\equiv$																																																																																							
O2-RLY	1 ⊗	13 ⊗	14 ⊗	6 ⊗	USER INPUT 1																																																																																							
O2-RLY	2 ⊗	⊗	⊗	7 ⊗	INPUT A																																																																																							
O1-RLY	3 ⊗			8 ⊗	INPUT/USER B																																																																																							
O1-RLY	4 ⊗	⊗	⊗	9 ⊗	COMM.																																																																																							
USER INPUT 2	5 ⊗	11 ⊗	12 ⊗	10 ⊗	DC OUT/IN $\equiv$																																																																																							
COMM.	1 ⊗	13 ⊗	14 ⊗	6 ⊗	USER INPUT 1																																																																																							
O1-SS	2 ⊗	⊗	⊗	7 ⊗	INPUT A																																																																																							
O2-SS	3 ⊗			8 ⊗	INPUT/USER B																																																																																							
N/C	4 ⊗	⊗	⊗	9 ⊗	COMM.																																																																																							
USER INPUT 2	5 ⊗	11 ⊗	12 ⊗	10 ⊗	DC OUT/IN $\equiv$																																																																																							
<p><b>C48CP - DUAL PRESET W/PRESCALER OUTPUT SOLID-STATE OUTPUTS</b></p> <p>RS-485 OPTION B(-)A(+)</p> <table border="1"> <tr> <td>COMM.</td> <td>1 ⊗</td> <td>13 ⊗</td> <td>14 ⊗</td> <td>6 ⊗</td> <td>USER INPUT 1</td> </tr> <tr> <td>O1-SS</td> <td>2 ⊗</td> <td>⊗</td> <td>⊗</td> <td>7 ⊗</td> <td>INPUT A</td> </tr> <tr> <td>O2-SS</td> <td>3 ⊗</td> <td></td> <td></td> <td>8 ⊗</td> <td>INPUT/USER B</td> </tr> <tr> <td>PSC-SS</td> <td>4 ⊗</td> <td>⊗</td> <td>⊗</td> <td>9 ⊗</td> <td>COMM.</td> </tr> <tr> <td>USER INPUT 2</td> <td>5 ⊗</td> <td>11 ⊗</td> <td>12 ⊗</td> <td>10 ⊗</td> <td>DC OUT/IN <math>\equiv</math></td> </tr> </table> <p style="text-align: center;">~ AC ~ AC</p>	COMM.	1 ⊗	13 ⊗	14 ⊗	6 ⊗	USER INPUT 1	O1-SS	2 ⊗	⊗	⊗	7 ⊗	INPUT A	O2-SS	3 ⊗			8 ⊗	INPUT/USER B	PSC-SS	4 ⊗	⊗	⊗	9 ⊗	COMM.	USER INPUT 2	5 ⊗	11 ⊗	12 ⊗	10 ⊗	DC OUT/IN $\equiv$	<p><b>C48CB - THREE PRESET RELAY OUTPUTS (02 &amp; 03) SOLID-STATE OUTPUT (01)</b></p> <p>RS-485 OPTION B(-)A(+)</p> <table border="1"> <tr> <td>O2-RLY</td> <td>1 ⊗</td> <td>13 ⊗</td> <td>14 ⊗</td> <td>6 ⊗</td> <td>USER INPUT 1</td> </tr> <tr> <td>O2-RLY</td> <td>2 ⊗</td> <td>⊗</td> <td>⊗</td> <td>7 ⊗</td> <td>INPUT A</td> </tr> <tr> <td>O3-RLY</td> <td>3 ⊗</td> <td></td> <td></td> <td>8 ⊗</td> <td>INPUT/USER B</td> </tr> <tr> <td>O3-RLY</td> <td>4 ⊗</td> <td>⊗</td> <td>⊗</td> <td>9 ⊗</td> <td>COMM.</td> </tr> <tr> <td>O1-SS</td> <td>5 ⊗</td> <td>11 ⊗</td> <td>12 ⊗</td> <td>10 ⊗</td> <td>DC OUT/IN <math>\equiv</math></td> </tr> </table> <p style="text-align: center;">~ AC ~ AC</p>	O2-RLY	1 ⊗	13 ⊗	14 ⊗	6 ⊗	USER INPUT 1	O2-RLY	2 ⊗	⊗	⊗	7 ⊗	INPUT A	O3-RLY	3 ⊗			8 ⊗	INPUT/USER B	O3-RLY	4 ⊗	⊗	⊗	9 ⊗	COMM.	O1-SS	5 ⊗	11 ⊗	12 ⊗	10 ⊗	DC OUT/IN $\equiv$	<p><b>C48CB - THREE PRESET SOLID-STATE OUTPUT</b></p> <p>RS-485 OPTION B(-)A(+)</p> <table border="1"> <tr> <td>COMM.</td> <td>1 ⊗</td> <td>13 ⊗</td> <td>14 ⊗</td> <td>6 ⊗</td> <td>USER INPUT 1</td> </tr> <tr> <td>O1-SS</td> <td>2 ⊗</td> <td>⊗</td> <td>⊗</td> <td>7 ⊗</td> <td>INPUT A</td> </tr> <tr> <td>O2-SS</td> <td>3 ⊗</td> <td></td> <td></td> <td>8 ⊗</td> <td>INPUT/USER B</td> </tr> <tr> <td>O3-SS</td> <td>4 ⊗</td> <td>⊗</td> <td>⊗</td> <td>9 ⊗</td> <td>COMM.</td> </tr> <tr> <td>USER INPUT 2</td> <td>5 ⊗</td> <td>11 ⊗</td> <td>12 ⊗</td> <td>10 ⊗</td> <td>DC OUT/IN <math>\equiv</math></td> </tr> </table> <p style="text-align: center;">~ AC ~ AC</p>	COMM.	1 ⊗	13 ⊗	14 ⊗	6 ⊗	USER INPUT 1	O1-SS	2 ⊗	⊗	⊗	7 ⊗	INPUT A	O2-SS	3 ⊗			8 ⊗	INPUT/USER B	O3-SS	4 ⊗	⊗	⊗	9 ⊗	COMM.	USER INPUT 2	5 ⊗	11 ⊗	12 ⊗	10 ⊗	DC OUT/IN $\equiv$
COMM.	1 ⊗	13 ⊗	14 ⊗	6 ⊗	USER INPUT 1																																																																																							
O1-SS	2 ⊗	⊗	⊗	7 ⊗	INPUT A																																																																																							
O2-SS	3 ⊗			8 ⊗	INPUT/USER B																																																																																							
PSC-SS	4 ⊗	⊗	⊗	9 ⊗	COMM.																																																																																							
USER INPUT 2	5 ⊗	11 ⊗	12 ⊗	10 ⊗	DC OUT/IN $\equiv$																																																																																							
O2-RLY	1 ⊗	13 ⊗	14 ⊗	6 ⊗	USER INPUT 1																																																																																							
O2-RLY	2 ⊗	⊗	⊗	7 ⊗	INPUT A																																																																																							
O3-RLY	3 ⊗			8 ⊗	INPUT/USER B																																																																																							
O3-RLY	4 ⊗	⊗	⊗	9 ⊗	COMM.																																																																																							
O1-SS	5 ⊗	11 ⊗	12 ⊗	10 ⊗	DC OUT/IN $\equiv$																																																																																							
COMM.	1 ⊗	13 ⊗	14 ⊗	6 ⊗	USER INPUT 1																																																																																							
O1-SS	2 ⊗	⊗	⊗	7 ⊗	INPUT A																																																																																							
O2-SS	3 ⊗			8 ⊗	INPUT/USER B																																																																																							
O3-SS	4 ⊗	⊗	⊗	9 ⊗	COMM.																																																																																							
USER INPUT 2	5 ⊗	11 ⊗	12 ⊗	10 ⊗	DC OUT/IN $\equiv$																																																																																							

# TERMINAL CONFIGURATIONS FOR C48 COUNTERS (Cont'd)

## C48CXX1X VERSIONS (18 to 36 VDC/24 VAC POWERED)



**CAUTION:** Observe proper polarity when connecting DC voltages. Damage to the unit will occur if polarity is reversed.

<p><b>C48CS - SINGLE PRESET RELAY AND SOLID-STATE OUTPUTS</b></p> <p>RS-485 OPTION B(-) A(+)</p> <table border="1"> <tr> <td>COMM.</td> <td>1</td> <td>⊗</td> <td>13</td> <td>14</td> <td>⊗</td> <td>6</td> <td>USER INPUT 1</td> </tr> <tr> <td>01-SS</td> <td>2</td> <td>⊗</td> <td>⊗</td> <td>⊗</td> <td>⊗</td> <td>7</td> <td>INPUT A</td> </tr> <tr> <td>01-RLY</td> <td>3</td> <td>⊗</td> <td></td> <td></td> <td>⊗</td> <td>8</td> <td>INPUT/USER B</td> </tr> <tr> <td>01-RLY</td> <td>4</td> <td>⊗</td> <td>⊗</td> <td>⊗</td> <td>⊗</td> <td>9</td> <td>COMM.</td> </tr> <tr> <td>USER INPUT 2</td> <td>5</td> <td>⊗</td> <td>11</td> <td>12</td> <td>⊗</td> <td>10</td> <td>DC OUT (V<sub>src</sub> IN)</td> </tr> <tr> <td></td> <td></td> <td></td> <td>DC+ (AC)</td> <td>DC- (AC)</td> <td></td> <td></td> <td></td> </tr> </table>	COMM.	1	⊗	13	14	⊗	6	USER INPUT 1	01-SS	2	⊗	⊗	⊗	⊗	7	INPUT A	01-RLY	3	⊗			⊗	8	INPUT/USER B	01-RLY	4	⊗	⊗	⊗	⊗	9	COMM.	USER INPUT 2	5	⊗	11	12	⊗	10	DC OUT (V <sub>src</sub> IN)				DC+ (AC)	DC- (AC)				<p><b>C48CD - DUAL PRESET RELAY OUTPUTS</b></p> <p>RS-485 OPTION B(-) A(+)</p> <table border="1"> <tr> <td>02-RLY</td> <td>1</td> <td>⊗</td> <td>13</td> <td>14</td> <td>⊗</td> <td>6</td> <td>USER INPUT 1</td> </tr> <tr> <td>02-RLY</td> <td>2</td> <td>⊗</td> <td>⊗</td> <td>⊗</td> <td>⊗</td> <td>7</td> <td>INPUT A</td> </tr> <tr> <td>01-RLY</td> <td>3</td> <td>⊗</td> <td></td> <td></td> <td>⊗</td> <td>8</td> <td>INPUT/USER B</td> </tr> <tr> <td>01-RLY</td> <td>4</td> <td>⊗</td> <td>⊗</td> <td>⊗</td> <td>⊗</td> <td>9</td> <td>COMM.</td> </tr> <tr> <td>USER INPUT 2</td> <td>5</td> <td>⊗</td> <td>11</td> <td>12</td> <td>⊗</td> <td>10</td> <td>DC OUT (V<sub>src</sub> IN)</td> </tr> <tr> <td></td> <td></td> <td></td> <td>DC+ (AC)</td> <td>DC- (AC)</td> <td></td> <td></td> <td></td> </tr> </table>	02-RLY	1	⊗	13	14	⊗	6	USER INPUT 1	02-RLY	2	⊗	⊗	⊗	⊗	7	INPUT A	01-RLY	3	⊗			⊗	8	INPUT/USER B	01-RLY	4	⊗	⊗	⊗	⊗	9	COMM.	USER INPUT 2	5	⊗	11	12	⊗	10	DC OUT (V <sub>src</sub> IN)				DC+ (AC)	DC- (AC)				<p><b>C48CD - DUAL PRESET SOLID-STATE OUTPUTS</b></p> <p>RS-485 OPTION B(-) A(+)</p> <table border="1"> <tr> <td>COMM.</td> <td>1</td> <td>⊗</td> <td>13</td> <td>14</td> <td>⊗</td> <td>6</td> <td>USER INPUT 1</td> </tr> <tr> <td>01-SS</td> <td>2</td> <td>⊗</td> <td>⊗</td> <td>⊗</td> <td>⊗</td> <td>7</td> <td>INPUT A</td> </tr> <tr> <td>02-SS</td> <td>3</td> <td>⊗</td> <td></td> <td></td> <td>⊗</td> <td>8</td> <td>INPUT/USER B</td> </tr> <tr> <td>N/C</td> <td>4</td> <td>⊗</td> <td>⊗</td> <td>⊗</td> <td>⊗</td> <td>9</td> <td>COMM.</td> </tr> <tr> <td>USER INPUT 2</td> <td>5</td> <td>⊗</td> <td>11</td> <td>12</td> <td>⊗</td> <td>10</td> <td>DC OUT (V<sub>src</sub> IN)</td> </tr> <tr> <td></td> <td></td> <td></td> <td>DC+ (AC)</td> <td>DC- (AC)</td> <td></td> <td></td> <td></td> </tr> </table>	COMM.	1	⊗	13	14	⊗	6	USER INPUT 1	01-SS	2	⊗	⊗	⊗	⊗	7	INPUT A	02-SS	3	⊗			⊗	8	INPUT/USER B	N/C	4	⊗	⊗	⊗	⊗	9	COMM.	USER INPUT 2	5	⊗	11	12	⊗	10	DC OUT (V <sub>src</sub> IN)				DC+ (AC)	DC- (AC)			
COMM.	1	⊗	13	14	⊗	6	USER INPUT 1																																																																																																																																											
01-SS	2	⊗	⊗	⊗	⊗	7	INPUT A																																																																																																																																											
01-RLY	3	⊗			⊗	8	INPUT/USER B																																																																																																																																											
01-RLY	4	⊗	⊗	⊗	⊗	9	COMM.																																																																																																																																											
USER INPUT 2	5	⊗	11	12	⊗	10	DC OUT (V <sub>src</sub> IN)																																																																																																																																											
			DC+ (AC)	DC- (AC)																																																																																																																																														
02-RLY	1	⊗	13	14	⊗	6	USER INPUT 1																																																																																																																																											
02-RLY	2	⊗	⊗	⊗	⊗	7	INPUT A																																																																																																																																											
01-RLY	3	⊗			⊗	8	INPUT/USER B																																																																																																																																											
01-RLY	4	⊗	⊗	⊗	⊗	9	COMM.																																																																																																																																											
USER INPUT 2	5	⊗	11	12	⊗	10	DC OUT (V <sub>src</sub> IN)																																																																																																																																											
			DC+ (AC)	DC- (AC)																																																																																																																																														
COMM.	1	⊗	13	14	⊗	6	USER INPUT 1																																																																																																																																											
01-SS	2	⊗	⊗	⊗	⊗	7	INPUT A																																																																																																																																											
02-SS	3	⊗			⊗	8	INPUT/USER B																																																																																																																																											
N/C	4	⊗	⊗	⊗	⊗	9	COMM.																																																																																																																																											
USER INPUT 2	5	⊗	11	12	⊗	10	DC OUT (V <sub>src</sub> IN)																																																																																																																																											
			DC+ (AC)	DC- (AC)																																																																																																																																														
<p><b>C48CP - DUAL PRESET W/PRESCALER OUTPUT SOLID-STATE OUTPUTS</b></p> <p>RS-485 OPTION B(-) A(+)</p> <table border="1"> <tr> <td>COMM.</td> <td>1</td> <td>⊗</td> <td>13</td> <td>14</td> <td>⊗</td> <td>6</td> <td>USER INPUT 1</td> </tr> <tr> <td>01-SS</td> <td>2</td> <td>⊗</td> <td>⊗</td> <td>⊗</td> <td>⊗</td> <td>7</td> <td>INPUT A</td> </tr> <tr> <td>02-SS</td> <td>3</td> <td>⊗</td> <td></td> <td></td> <td>⊗</td> <td>8</td> <td>INPUT/USER B</td> </tr> <tr> <td>PSC-SS</td> <td>4</td> <td>⊗</td> <td>⊗</td> <td>⊗</td> <td>⊗</td> <td>9</td> <td>COMM.</td> </tr> <tr> <td>USER INPUT 2</td> <td>5</td> <td>⊗</td> <td>11</td> <td>12</td> <td>⊗</td> <td>10</td> <td>DC OUT (V<sub>src</sub> IN)</td> </tr> <tr> <td></td> <td></td> <td></td> <td>DC+ (AC)</td> <td>DC- (AC)</td> <td></td> <td></td> <td></td> </tr> </table>	COMM.	1	⊗	13	14	⊗	6	USER INPUT 1	01-SS	2	⊗	⊗	⊗	⊗	7	INPUT A	02-SS	3	⊗			⊗	8	INPUT/USER B	PSC-SS	4	⊗	⊗	⊗	⊗	9	COMM.	USER INPUT 2	5	⊗	11	12	⊗	10	DC OUT (V <sub>src</sub> IN)				DC+ (AC)	DC- (AC)				<p><b>C48CB - THREE PRESET RELAY OUTPUTS (02 &amp; 03) SOLID-STATE OUTPUT (01)</b></p> <p>RS-485 OPTION B(-) A(+)</p> <table border="1"> <tr> <td>02-RLY</td> <td>1</td> <td>⊗</td> <td>13</td> <td>14</td> <td>⊗</td> <td>6</td> <td>USER INPUT 1</td> </tr> <tr> <td>02-RLY</td> <td>2</td> <td>⊗</td> <td>⊗</td> <td>⊗</td> <td>⊗</td> <td>7</td> <td>INPUT A</td> </tr> <tr> <td>03-RLY</td> <td>3</td> <td>⊗</td> <td></td> <td></td> <td>⊗</td> <td>8</td> <td>INPUT/USER B</td> </tr> <tr> <td>03-RLY</td> <td>4</td> <td>⊗</td> <td>⊗</td> <td>⊗</td> <td>⊗</td> <td>9</td> <td>COMM.</td> </tr> <tr> <td>01-SS</td> <td>5</td> <td>⊗</td> <td>11</td> <td>12</td> <td>⊗</td> <td>10</td> <td>DC OUT (V<sub>src</sub> IN)</td> </tr> <tr> <td></td> <td></td> <td></td> <td>DC+ (AC)</td> <td>DC- (AC)</td> <td></td> <td></td> <td></td> </tr> </table>	02-RLY	1	⊗	13	14	⊗	6	USER INPUT 1	02-RLY	2	⊗	⊗	⊗	⊗	7	INPUT A	03-RLY	3	⊗			⊗	8	INPUT/USER B	03-RLY	4	⊗	⊗	⊗	⊗	9	COMM.	01-SS	5	⊗	11	12	⊗	10	DC OUT (V <sub>src</sub> IN)				DC+ (AC)	DC- (AC)				<p><b>C48CB - THREE PRESET SOLID-STATE OUTPUTS</b></p> <p>RS-485 OPTION B(-) A(+)</p> <table border="1"> <tr> <td>COMM.</td> <td>1</td> <td>⊗</td> <td>13</td> <td>14</td> <td>⊗</td> <td>6</td> <td>USER INPUT 1</td> </tr> <tr> <td>01-SS</td> <td>2</td> <td>⊗</td> <td>⊗</td> <td>⊗</td> <td>⊗</td> <td>7</td> <td>INPUT A</td> </tr> <tr> <td>02-SS</td> <td>3</td> <td>⊗</td> <td></td> <td></td> <td>⊗</td> <td>8</td> <td>INPUT/USER B</td> </tr> <tr> <td>03-SS</td> <td>4</td> <td>⊗</td> <td>⊗</td> <td>⊗</td> <td>⊗</td> <td>9</td> <td>COMM.</td> </tr> <tr> <td>USER INPUT 2</td> <td>5</td> <td>⊗</td> <td>11</td> <td>12</td> <td>⊗</td> <td>10</td> <td>DC OUT (V<sub>src</sub> IN)</td> </tr> <tr> <td></td> <td></td> <td></td> <td>DC+ (AC)</td> <td>DC- (AC)</td> <td></td> <td></td> <td></td> </tr> </table>	COMM.	1	⊗	13	14	⊗	6	USER INPUT 1	01-SS	2	⊗	⊗	⊗	⊗	7	INPUT A	02-SS	3	⊗			⊗	8	INPUT/USER B	03-SS	4	⊗	⊗	⊗	⊗	9	COMM.	USER INPUT 2	5	⊗	11	12	⊗	10	DC OUT (V <sub>src</sub> IN)				DC+ (AC)	DC- (AC)			
COMM.	1	⊗	13	14	⊗	6	USER INPUT 1																																																																																																																																											
01-SS	2	⊗	⊗	⊗	⊗	7	INPUT A																																																																																																																																											
02-SS	3	⊗			⊗	8	INPUT/USER B																																																																																																																																											
PSC-SS	4	⊗	⊗	⊗	⊗	9	COMM.																																																																																																																																											
USER INPUT 2	5	⊗	11	12	⊗	10	DC OUT (V <sub>src</sub> IN)																																																																																																																																											
			DC+ (AC)	DC- (AC)																																																																																																																																														
02-RLY	1	⊗	13	14	⊗	6	USER INPUT 1																																																																																																																																											
02-RLY	2	⊗	⊗	⊗	⊗	7	INPUT A																																																																																																																																											
03-RLY	3	⊗			⊗	8	INPUT/USER B																																																																																																																																											
03-RLY	4	⊗	⊗	⊗	⊗	9	COMM.																																																																																																																																											
01-SS	5	⊗	11	12	⊗	10	DC OUT (V <sub>src</sub> IN)																																																																																																																																											
			DC+ (AC)	DC- (AC)																																																																																																																																														
COMM.	1	⊗	13	14	⊗	6	USER INPUT 1																																																																																																																																											
01-SS	2	⊗	⊗	⊗	⊗	7	INPUT A																																																																																																																																											
02-SS	3	⊗			⊗	8	INPUT/USER B																																																																																																																																											
03-SS	4	⊗	⊗	⊗	⊗	9	COMM.																																																																																																																																											
USER INPUT 2	5	⊗	11	12	⊗	10	DC OUT (V <sub>src</sub> IN)																																																																																																																																											
			DC+ (AC)	DC- (AC)																																																																																																																																														

## APPENDIX “F” - ORDERING INFORMATION

### SINGLE AND DUAL PRESET COUNTERS

MODEL NO.	DESCRIPTION	NPN O.C. * OUTPUT(S)	RELAY OUTPUT(S)	RS485	PART NUMBERS FOR AVAILABLE SUPPLY VOLTAGES		REPLACEMENT RELAY OUTPUT BOARD
					18-36 VDC/24 VAC	85 to 250 VAC	
C48CS	1 Preset Counter, Reflective LCD	Yes	Yes	No	C48CS013	C48CS003	RBC48001
	1 Preset Counter, Backlit LCD	Yes	Yes	No	C48CS113	C48CS103	RBC48001
C48CD	2 Preset Counter, Reflective LCD	Yes	No	Yes	C48CD015	C48CD005	N/A
	2 Preset Counter, Reflective LCD	No	Yes	No	C48CD012	C48CD002	RBC48003
	2 Preset Counter, Reflective LCD	No	Yes	Yes	C48CD017	C48CD007	RBC48003
	2 Preset Counter, Backlit LCD	Yes	No	No	C48CD110	C48CD100	N/A
	2 Preset Counter, Backlit LCD	Yes	No	Yes	C48CD115	C48CD105	N/A
	2 Preset Counter, Backlit LCD	No	Yes	No	C48CD112	C48CD102	RBC48003
C48CP	2 Preset Counter, Backlit LCD	No	Yes	Yes	C48CD117	C48CD107	RBC48003
	2 Preset Counter w/Prescaler Output, Reflective LCD	Yes	No	Yes	C48CP015	C48CP005	N/A
	2 Preset Counter w/Prescaler Output, Backlit LCD	Yes	No	No	C48CP110	C48CP100	N/A
	2 Preset Counter w/Prescaler Output, Backlit LCD	Yes	No	Yes	C48CP115	C48CP105	N/A

\*PNP O.C. Output(s) versions available, contact the factory.

### THREE PRESET BATCH COUNTERS

MODEL NO.	DESCRIPTION	NPN O.C. * OUTPUT(S)	RELAY OUTPUT(S)	RS485	PART NUMBERS FOR AVAILABLE SUPPLY VOLTAGES		REPLACEMENT RELAY OUTPUT BOARD
					18-36 VDC/24 VAC	85 to 250 VAC	
C48CB	3 Preset Batch Counter, Reflective LCD	Yes (O1)	Yes	No	N/A	C48CB003	RBC48004
	3 Preset Batch Counter, Reflective LCD	Yes (O1)	Yes	Yes	N/A	C48CB008	RBC48004
	3 Preset Batch Counter, Reflective LCD	Yes	No	Yes	N/A	C48CB005	N/A
	3 Preset Batch Counter, Backlit LCD	Yes (O1)	Yes	No	N/A	C48CB103	RBC48004
	3 Preset Batch Counter, Backlit LCD	Yes (O1)	Yes	Yes	N/A	C48CB108	RBC48004
	3 Preset Batch Counter, Backlit LCD	Yes	No	No	C48CB110	C48CB100	N/A
	3 Preset Batch Counter, Backlit LCD	Yes	No	Yes	N/A	C48CB105	N/A

*Note: On Batch Relay Models, Outputs 2 and 3 are Relays, and Output 1 is a solid-state output.*

*\*PNP O.C. Output(s) versions available, contact the factory.*

MODEL NO.	DESCRIPTION	PART NUMBER
SFC48	PC Configuration Software for Windows 3.x and 95 (3.5" disk)	SFC48

## LIMITED WARRANTY

*The Company warrants the products it manufactures against defects in materials and workmanship for a period limited to one year from the date of shipment, provided the products have been stored, handled, installed, and used under proper conditions. The Company's liability under this limited warranty shall extend only to the repair or replacement of a defective product, at The Company's option. The Company disclaims all liability for any affirmation, promise or representation with respect to the products.*

*The customer agrees to hold Red Lion Controls harmless from, defend, and indemnify RLC against damages, claims, and expenses arising out of subsequent sales of RLC products or products containing components manufactured by RLC and based upon personal injuries, deaths, property damage, lost profits, and other matters which Buyer, its employees, or sub-contractors are or may be to any extent liable, including without limitation penalties imposed by the Consumer Product Safety Act (P.L. 92-573) and liability imposed upon any person pursuant to the Magnuson-Moss Warranty Act (P.L. 93-637), as now in effect or as amended hereafter.*

*No warranties expressed or implied are created with respect to The Company's products except those expressly contained herein. The Customer acknowledges the disclaimers and limitations contained and relies on no other warranties or affirmations.*



Red Lion Controls  
20 Willow Springs Circle  
York PA 17402  
Tel +1 (717) 767-6511  
Fax +1 (717) 764-0839

Red Lion Controls BV  
Basicweg 11b  
NL - 3821 BR Amersfoort  
Tel +31 (0) 334 723 225  
Fax +31 (0) 334 893 793

Red Lion Controls AP  
31, Kaki Bukit Road 3,  
#06-04/05 TechLink  
Singapore 417818  
Tel +65 6744-6613  
Fax +65 6743-3360