

MCC

REPAIR PARTS

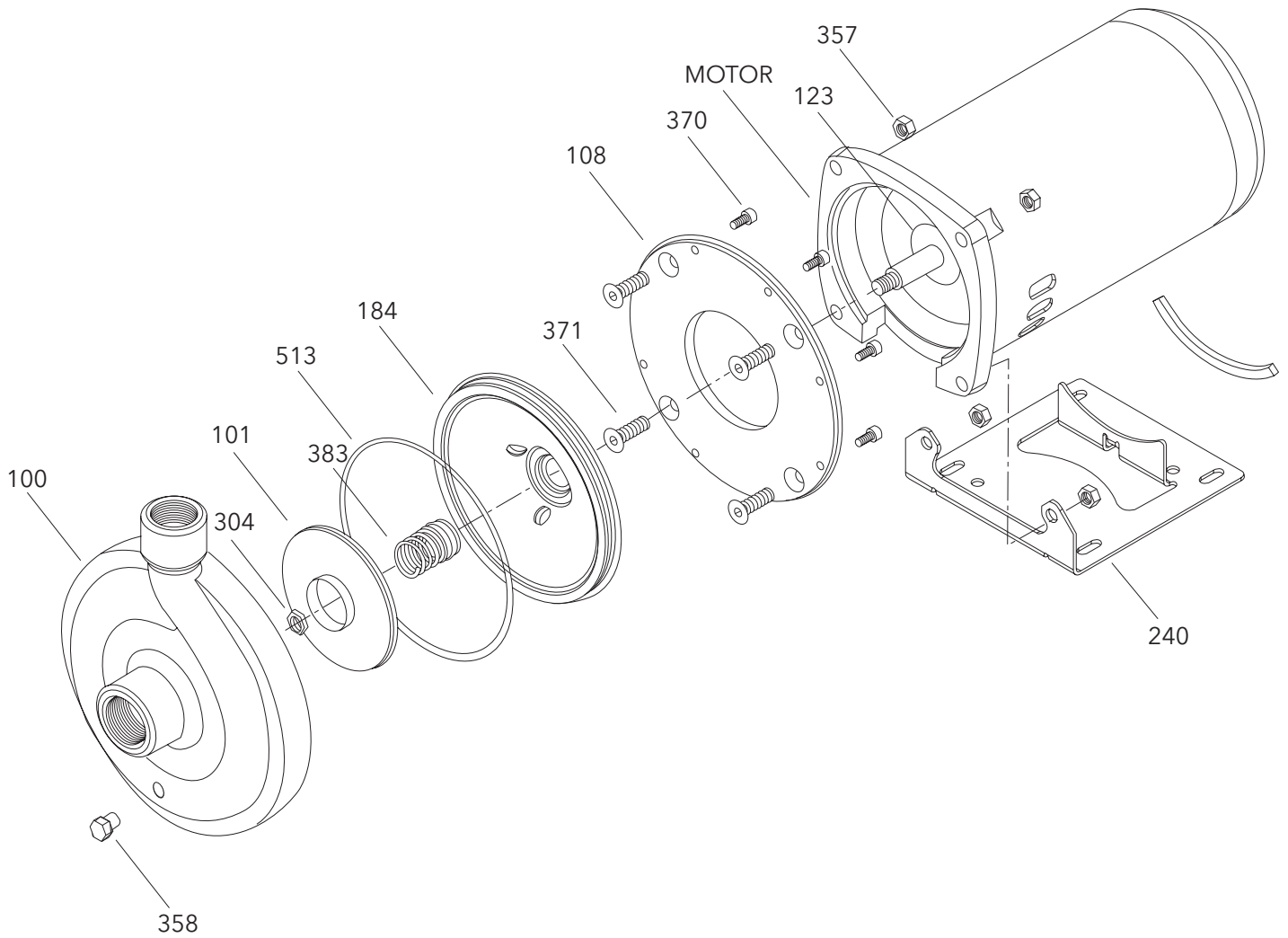

Item No.	Description	Materials of Construction	1MC 1 x 1¼	2MC 1¼ x 1½	3MC 1½ x 2	Quantity
100	Casing	Iron	1K337	1K338	1K339	1
101	Impeller	AISI 316L SS	See Impeller Chart			1
108	Motor adapter	Aluminum	1K336			1
123	Deflector	BUNA-N	5K7			1
184	Seal housing	AISI 316L SS	1L79			1
240	Motor support	Steel	4K628			1
	Rubber channel - 56 FRM - 48 FRM	Rubber	9K188			1
			9K286			1
304	Impeller locknut	AISI 316 SS	13K286			1
357	Nut, motor	AISI 300 SS	13K262			4
358	Plug, drain	Plated Steel	6K2			1
370	Socket head screw, casing	AISI 410 SS	13K268			8
371	Bolts, motor	AISI 300 SS	13K287			4
383	Mechanical seal	-	See mechanical seal chart			1
513	O-ring, casing	BUNA	5K4			1
		EPR	5K193			
		Viton standard	5K206			

Mechanical Seal (5/8" Seal)				
Rotary	Stationary	Elastomers	Metal Parts	Part No.
Carbon	Ceramic	BUNA	18-8SS	10K10
		EPR	316SS	10K18
		Viton		10K55*
Sil-Carbide	Sil-Carbide	EPR	316SS	10K81
		Viton		10K62

Note: *Replaces obsolete 10K24

Impeller Code	Pump Size					
	1MC 1 x 1¼ - 6		2MC 1¼ x 1½ - 6		3MC 1½ x 2 - 6	
	Diameter	Part No.	Diameter	Part No.	Diameter	Part No.
K	-	-	6⅞	2K1221	-	-
G	-	-	5⅞	2K1206	5⅞	2K1209
H	-	-	5½	2K1205	5	2K1208
A	6⅞	2K1203	5¼	2K1216	4¾	2K1220
B	5¾	2K1202	5⅞	2K1204	4⅞	2K1207
C	5⅞	2K1201	4⅞	2K1215	4⅞	2K1219
D	4¾	2K1200	4⅞	2K1214	4⅞	2K1218
E	4⅞	2K1199	4¼	2K1213	3⅞	2K1217
F	4⅞	2K1211	3⅞	2K1212	-	-

Xylem Inc.

2881 East Bayard Street Ext., Suite A, Seneca Falls, NY 13148

Phone: (800) 453-6777 Fax: (888) 322-5877

www.gouldswatertechnology.com



Goulds is a registered trademark of Goulds Pumps, Inc. and is used under license.

G&L is a trademark of Xylem Inc. or one of its subsidiaries.

© 2012 Xylem Inc. RMCC R1 July 2013