

Sizes in millimeters
Dimensions en millimètres

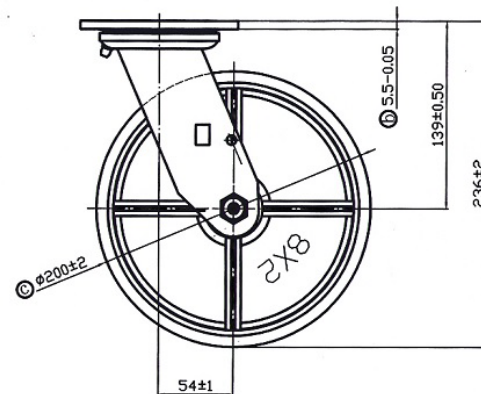

REFERENCE: F25108

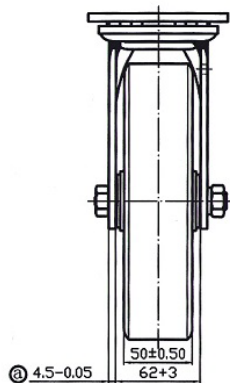