

Free Code - Combinaison Lock

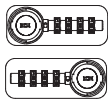

Lock for Cam

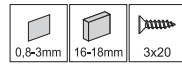
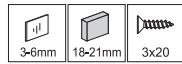
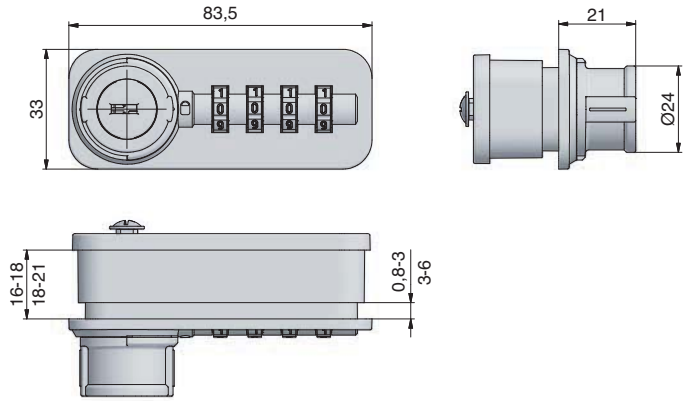

Order-No.	Order-No.	Finish	Position
<b>58021290</b>	<b>58018290</b>	black	Right
<b>58021390</b>	<b>58018390</b>	black	Left

System components

Straight Cam

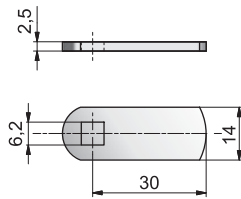

Finish
nickel plated

Offset Cam

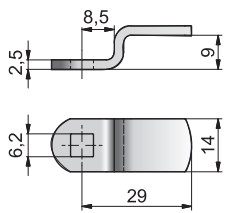

Finish
nickel plated

Hook Cam

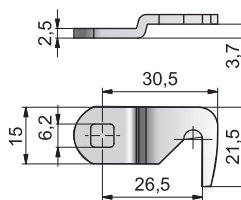

Finish
nickel plated

Free Code - Combinaison Lock

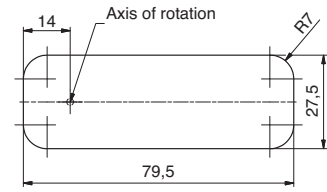
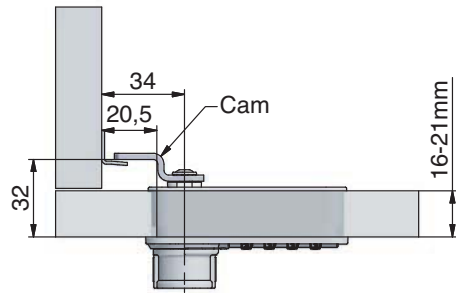

Milling groove

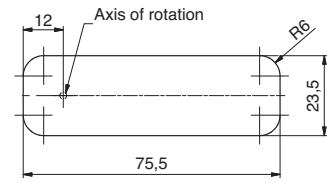
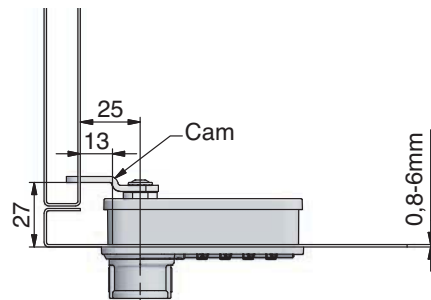

Stamping configuration

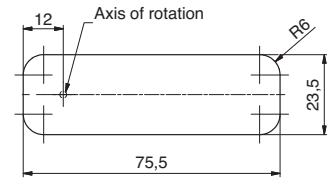
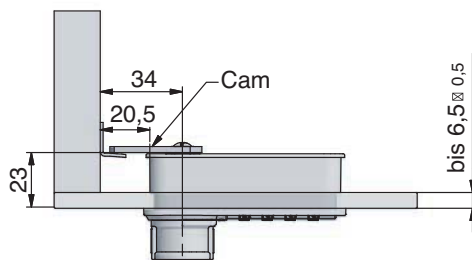

Stamping configuration

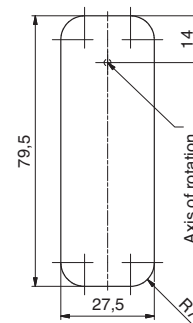
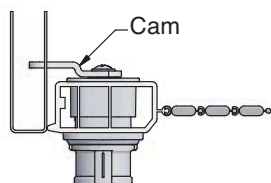
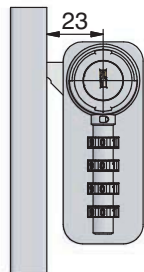

Milling groove