

SYSPEND ALUMINUM HMI ENCLOSURES, TYPE 12

INDUSTRY STANDARDS

 UL 508A Listed; Type 12; File No. E61997
 cUL Listed per CSA C22.2 No. 94; Type 12; File No. E61997

 NEMA/EEMAC Type 12
 IEC 60529; IP 65

APPLICATION

The SYSPEND Aluminum HMI enclosure is designed to accommodate modern touch-screen HMI devices and can be pendant- or pedestal-mounted. Extruded aluminum sides provide enhanced usability with internal mounting channels. The single-walled aluminum reduces the overall weight of the enclosure, eliminating strain during installation and use. The integrated side handles provide enhanced ergonomics. The SYSPEND Aluminum HMI enclosure's aesthetics are clean and modern and the life of the HMI system is extended due to increased heat dissipation.

FEATURES

- **Extruded, single-walled aluminum construction** for enhanced ergonomics and heat dissipation
- **Anodized and RAL 7035 sections**
- **Two body style options** for a variety of configurations
- **Integrated side handles** for clean appearance and ease of operation
- **Integrated mounting extrusions** for installing components or din rail directly inside the enclosure using brackets or spring nuts
- **Anodized aluminum front plate** installed into enclosure
- **Pre-cut mounting holes** compatible with support arm systems; pedestal mounting when enclosure is inverted

SPECIFICATIONS

- Extruded channels inside enclosure
- Seamless integrated handles
- Body is available hinged or solid with hinged back-plate
- Single-walled aluminum body
- Oil-resistant gasket attached with oil-resistant adhesive

FINISH

Enclosure vertical components are clear anodized aluminum; horizontal components are painted RAL 7035 light gray aluminum. Rear covers and front plates have a clear anodized aluminum finish.

BULLETIN: VMA
Standard Product Hinged Back Plate

Catalog Number	AxBxC mm/in.	X mm/in.	Y mm/in.	Z mm/in.	Weight (kg)	Weight (lb.)	Compatibility	Replacement Front Plate
SY222266A	336 x 350 x 80	225	225	66	5.27	11.62	COMPACT Series 2 Flange Coupling, SYSPEND 180-MAX*	SY2222AFP
	13.23 x 13.78 x 3.15	8.86	8.86	2.60				
SY273066A	386 x 425 x 80	275	300	66	6.84	15.08	COMPACT Series 2 Flange Coupling, SYSPEND 180-MAX*	SY2730AFP
	15.20 x 16.73 x 3.15	10.83	11.81	2.60				
SY322266A	436 x 350 x 80	325	225	66	6.30	13.89	COMPACT Series 2 Flange Coupling, SYSPEND 180-MAX*	SY3222AFP
	17.17 x 13.78 x 3.15	12.80	8.86	2.60				
SY323518A	436 x 475 x 200	325	350	186	13.27	29.26	Compact Series 2, SYSPEND 180-MAX, SYSPEND 281-MAX	SY3235AFP
	17.17 x 18.70 x 7.87	12.80	13.78	7.32				
SY353718A	461 x 500 x 200	350	375	186	14.29	31.50	Compact Series 2, SYSPEND 180-MAX, SYSPEND 281-MAX	SY3537AFP
	18.15 x 19.69 x 7.87	13.78	14.76	7.32				
SY405018A	511 x 625 x 200	400	500	186	18.03	39.75	Compact Series 2, SYSPEND 180-MAX, SYSPEND 281-MAX	SY4050AFP
	20.12 x 24.61 x 7.87	15.75	19.69	7.32				
SY455218A	561 x 650 x 200	450	525	186	19.78	43.61	Compact Series 2, SYSPEND 180-MAX, SYSPEND 281-MAX	SY4552AFP
	22.09 x 25.59 x 7.87	17.72	20.67	7.32				
SY605018A	711 x 625 x 200	600	500	186	22.76	50.18	Compact Series 4, System 80 **	SY6050AFP
	27.99 x 24.61 x 7.87	23.62	19.69	7.32				
SY505018A	611 x 625 x 200	500	500	186	20.39	44.95	Compact Series 4, System 80 **	SY5050AFP
	24.06 x 24.61 x 7.87	19.69	19.69	7.32				

XxYxZ dimensions refer to usable space (height x width x depth)

All enclosures come with front plates installed.

* Can be used with an adapter to accommodate the SYSPEND 180-MAX.

** Includes strengthening for pendant arm system due to dimensions.

Standard Product **Hinged Door**

Catalog Number	AxBxC mm/in.	X mm/in.	Y mm/in.	Z mm/in.	Weight (kg)	Weight (lbs.)	Compatibility	Replacement Front Plate
SY252516A	361 x 375 x 180 14.21 x 14.76 x 7.09	250 9.84	250 9.84	166 6.54	9.63	21.23	Compact Series 2, SYSPEND 180-MAX, SYSPEND 281-MAX	SY2525AFP
SY323716A	436 x 500 x 180 17.17 x 19.69 x 7.09	325 12.80	375 14.76	166 6.54	13.52	29.81	Compact Series 2, SYSPEND 180-MAX, SYSPEND 281-MAX	SY3237AFP
SY374216A	486 x 550 x 180 19.13 x 21.65 x 7.09	375 14.76	425 16.73	166 6.54	15.61	34.41	Compact Series 2, SYSPEND 180-MAX, SYSPEND 281-MAX	SY3742AFP
SY303016A	411 x 425 x 180 16.18 x 16.73 x 7.09	300 11.81	300 11.81	166 6.54	11.50	25.35	Compact Series 2, SYSPEND 180-MAX, SYSPEND 281-MAX	SY3030AFP
SY322516A	436 x 375 x 180 17.17 x 14.76 x 7.09	325 12.80	250 9.84	166 6.54	10.90	24.03	Compact Series 2, SYSPEND 180-MAX, SYSPEND 281-MAX	SY3225AFP
SY353516A	461 x 475 x 180 18.15 x 18.70 x 7.09	350 13.78	350 13.78	166 6.54	13.47	29.70	Compact Series 2, SYSPEND 180-MAX, SYSPEND 281-MAX	SY3535AFP
SY354516A	461 x 575 x 180 18.15 x 22.64 x 7.09	350 13.78	450 17.72	166 6.54	15.62	34.44	Compact Series 2, SYSPEND 180-MAX, SYSPEND 281-MAX	SY3545AFP
SY404016A	511 x 525 x 180 20.12 x 20.67 x 7.09	400 15.75	400 15.75	166 6.54	15.57	34.33	Compact Series 2, SYSPEND 180-MAX, SYSPEND 281-MAX	SY4040AFP
SY454716A	561 x 600 x 180 22.09 x 23.62 x 7.09	450 17.72	475 18.70	166 6.54	18.36	40.48	Compact Series 2, SYSPEND 180-MAX, SYSPEND 281-MAX	SY4547AFP
SY505216A	611 x 650 x 180 24.06 x 25.59 x 7.09	500 19.69	525 20.67	166 6.54	20.71	45.66	Compact Series 2, SYSPEND 180-MAX, SYSPEND 281-MAX	SY5052AFP
SY353726A	461 x 500 x 280 18.15 x 19.69 x 11.02	350 13.78	375 14.76	266 10.47	18.48	40.74	Compact Series 2, SYSPEND 180-MAX, SYSPEND 281-MAX	SY3537AFP
SY405026A	511 x 625 x 280 20.12 x 24.61 x 11.02	400 15.75	500 19.69	266 10.47	23.19	51.13	Compact Series 2, SYSPEND 180-MAX, SYSPEND 281-MAX	SY4050AFP
SY605026A	711 x 625 x 280 27.99 x 24.61 x 11.02	600 23.62	500 19.69	266 10.47	28.74	63.36	Compact Series 4, System 80 **	SY6050AFP
SY505026A	611 x 625 x 280 24.06 x 24.61 x 11.02	500 19.69	500 19.69	266 10.47	25.97	57.25	Compact Series 4, System 80 **	SY5050AFP

XxYxZ dimensions refer to usable space (height x width x depth)

All enclosures come with front plates installed.

** Includes strengthening for pendant arm system due to dimensions.

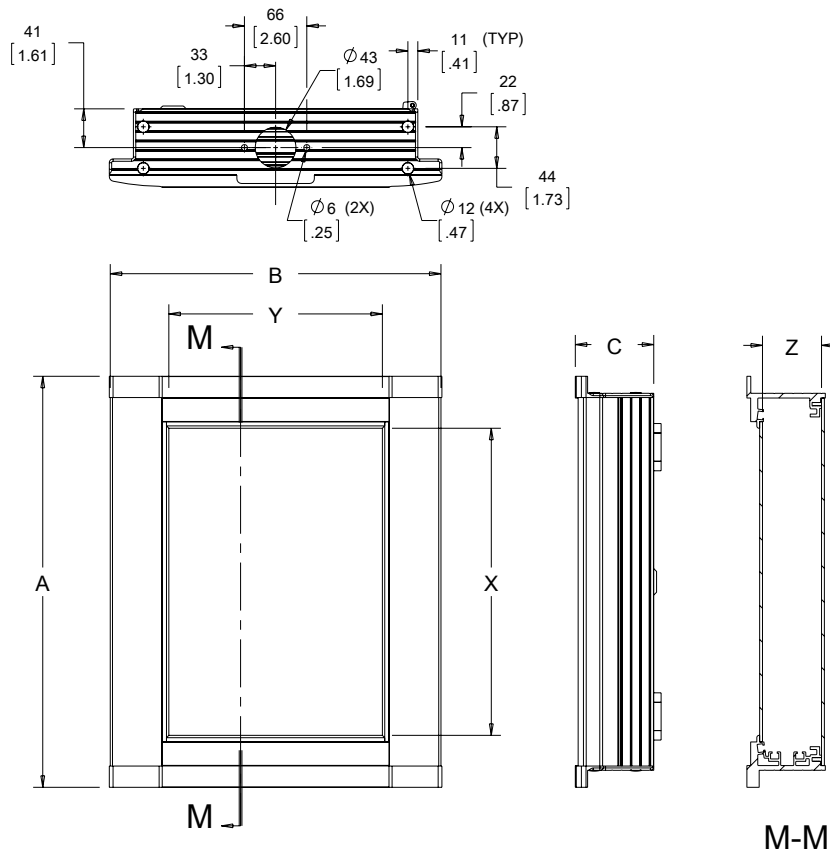

89143154

REPLACEMENT FRONT PLATE

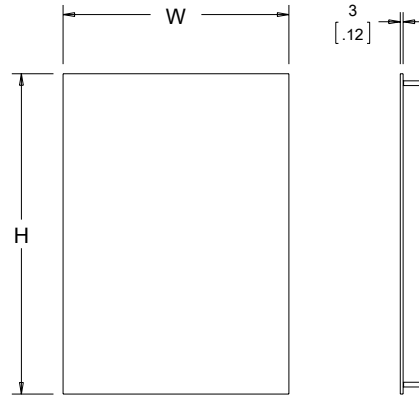
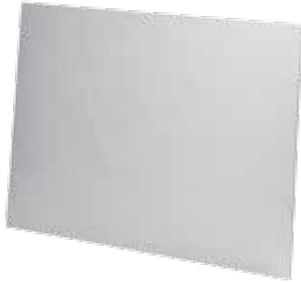

Front plates are 14 gauge aluminum with clear anodized brushed finish. Mounting hardware included.

BULLETIN: VMY

89143155

Standard Product

Catalog Number	AxB mm/in.	Fits Enclosure H x W mm	H mm/in.	W mm/in.	Weight (kg)	Weight (lb.)
SY2222AFP	239 x 239 9.41 x 9.41	225 x 225	239 9041	239 9.41	.59	1.30
SY2730AFP	389 x 314 11.38 x 12.36	275 x 300	389 11.38	314 12.36	.86	1.90
SY3222AFP	339 x 239 13.35 x 9.41	325 x 225	339 13.35	239 9.41	.78	1.72
SY3235AFP	339 x 364 13.35 x 14.33	325 x 350	339 13.35	364 14.33	1.12	2.47
SY3537AFP	364 x 389 14.33 x 15.32	350 x 375	364 14.33	389 15.32	1.27	2.80
SY4050AFP	414 x 514 16.30 x 20.24	400 x 500	414 16.30	514 20.24	1.85	4.08
SY4552AFP	464 x 539 18.27 x 21.22	450 x 525	464 18.27	539 21.22	2.15	4.74
SY6050AFP	614 x 514 24.17 x 20.24	600 x 500	614 24.17	514 20.24	2.68	5.91
SY5050AFP	514 x 514 20.24 x 20.24	500 x 500	514 20.24	514 20.24	2.26	4.99
SY2525AFP	264 x 264 10.39 x 10.39	250 x 250	264 10.39	264 10.39	.69	1.52
SY3237AFP	339 x 389 13.35 x 15.32	325 x 375	339 13.35	389 15.32	1.19	2.63
SY3742AFP	389 x 439 15.32 x 17.28	375 x 425	389 15.32	439 17.28	1.51	3.32
SY3030AFP	314 x 314 12.36 x 12.36	300 x 300	314 12.36	314 12.36	.92	2.04
SY3225AFP	339 x 264 13.35 x 10.39	325 x 250	339 13.35	264 10.39	.85	1.87
SY3535AFP	364 x 364 14.33 x 14.33	350 x 350	364 14.33	364 14.33	1.20	2.64
SY3545AFP	364 x 464 14.33 x 18.27	350 x 450	364 14.33	464 18.27	1.49	3.29
SY4040AFP	414 x 414 16.30 x 16.30	400 x 400	414 16.30	414 16.30	1.51	3.34
SY4547AFP	464 x 489 18.27 x 19.25	450 x 475	464 18.27	489 19.25	1.96	4.33
SY5052AFP	514 x 539 20.24 x 21.22	500 x 525	514 20.24	239 21.22	2.37	5.22

STEEL MOUNTING BRACKETS



Steel mounting brackets for installing components or DIN rails directly inside the enclosure.

BULLETIN: VMY

Catalog Number	Description
SYMBRK	Aluminum HMI Mounting Brackets

STEEL SPRING NUTS



No drilling required when using steel spring nuts to mount into enclosure. Package includes (10) M5 spring nuts.

BULLETIN: VMY

Catalog Number	Description
SYSPN	Aluminum HMI Spring Nuts

REPLACEMENT GROUNDING KIT



Grounding kit includes spring nuts for installation into mounting extrusions.

BULLETIN: VMY

Catalog Number	Description
SYAGK	Replacement Grounding Kit

REPLACEMENT KEY



Metallic 3-mm double-bit key.

BULLETIN: VMY

Standard Product

Catalog Number	Description
SYARK	Replacement Key



The interface allows access to programmable components installed inside the enclosure without opening the door. It can also be used as a keyboard or mouse connection.

BULLETIN: CC3

Catalog Number	Description
CCUSB	USB Data Port

Notes