

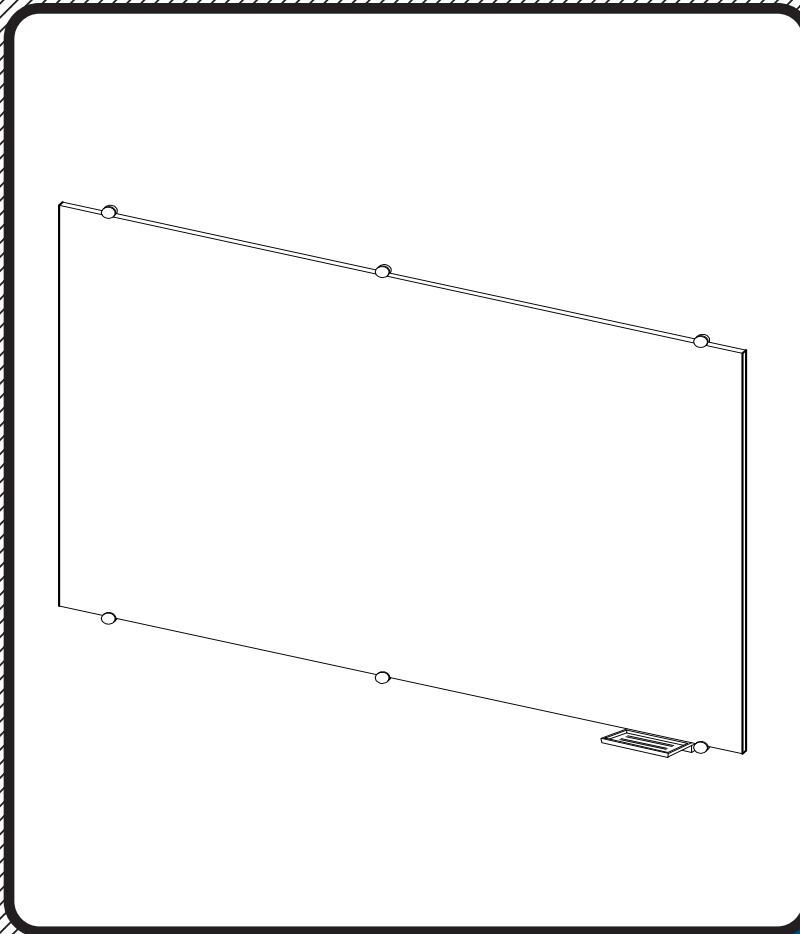

Visionary™ Boards



2' X 3', 3' X 4', 4' X 4', 4' X 6' and 4' X 8'



Assembly Instructions

Visionary™ Board

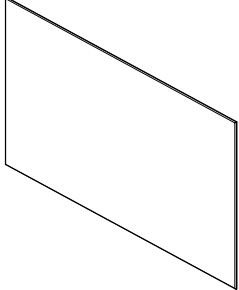
Part Drawing Description Qty



P-1		Glass Board	1 EA
P-2		Glass Tray	1 EA

Hardware Chart by Model # & Board Size

83843	2'X3' GBoard - 4 pcs. (A), (B) 6 pcs. (C), (D), (F) 2 pcs. (E)
83844	3'X4' GBoard - 4 pcs. (A), (B) 6 pcs. (C), (D), (F) 2 pcs. (E)
83847	4'X4' PJWBoard - 4 pcs. (A), (B) 6 pcs. (C), (D), (F) 2 pcs. (E)
83845	4'X6' GBoard - 6 pcs. (A), (B) 8 pcs. (C), (D), (F) 2 pcs. (E)
83846	4'X8' GBoard - 8 pcs. (A), (B) 10 pcs. (C), (D), (F) 2 pcs. (E)
83849	4'X4' PJGBoard- 4 pcs. (A),(B) 6 pcs. (C), (D), (F) 2 pcs. (E)
83848	4'X6' PJWBoard- 6 pcs. (A), (B) 8 pcs. (C), (D), (F) 2 pcs. (E)
83850	4'X6' PJGBoard-6 pcs. (A),(B) 8 pcs. (C), (D), (F) 2 pcs. (E)

Part Drawing Description Qty

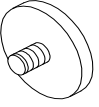
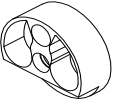
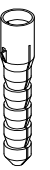
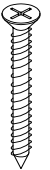
Hardware List

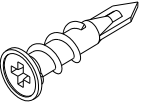
A		Outer Cap	See Chart
B		Wall Mount	See Chart
C		Plastic Anchor	See Chart
D		CS Screw	See Chart
E		Glass Tray Mount	See Chart
F		Drywall Anchor	See Chart

Missing Parts or UPS Damaged Parts

For Your Convenience you can
EMAIL us at

support@moorecoinc.com

24HOURS 7 DAYS A WEEK

Should you require assistance during assembly,

please call our

Customer Service Department

Monday - Friday 8 a.m. - 5 p.m.

Central Standard Time

Toll-Free Customer Service

1-800-749-2258

Important Information

Do not use unless all screws are tight. At least every six months, check all screws to be sure they are tight. If parts are missing, broken, damaged, or worn, stop use of the product until repairs are made by your dealer using factory authorized parts.

Preparing to Install Your New Visionary™ Board

Measure the length and width of your new board. Determine the wall center line and height off the floor that you want your new board to be located. Hold your board up in position and draw a line 3/8" above the top edge of your board and 3/8" below the bottom edge of your board. If your wall has studs, determine the centerline of the studs. It is recommended that you tie into as many studs as possible when mounting your board.

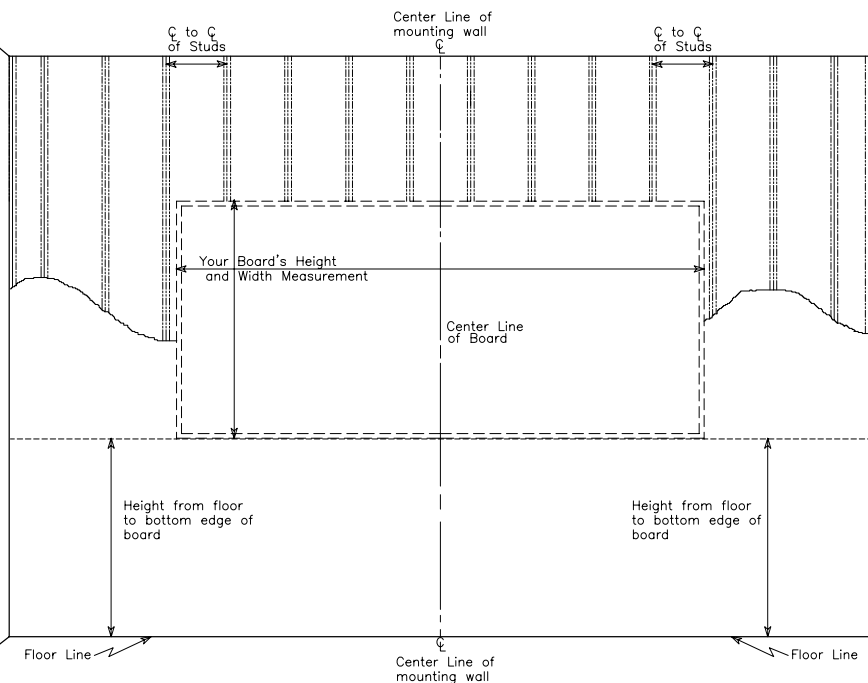

Typical Room With Stud Wall Centered Board Layout

NOTE: The proper installation of your board will require at least two people.
Tools required: Tape measure, chalkline, electric drill / screwdriver, drill and screwdriver bits, stud finder and level.

To Assemble and Attach to Wall:

- 1.) Identify and Separate all the Parts and Hardware.
- 2.) After you have followed the guidelines from the previous page, install the correct number of Board Mounts (B) for the size board you are mounting to the wall. Install the Board Mounts as shown in Illustration #1 and Illustration #1a.
- 3.) For all walls except sheet rock:

Predrill a 5/16" diameter hole on the line that was drawn 3/8" below and 3/8" above the top and bottom edges of your new board. Push in a Plastic Anchor (C) into the predrilled hole. Place the bottom hole in the Wall Mount (B) on top of the Plastic Anchor (C) and attach using one CS Screw (D). Repeat this Step for each Wall Mount that is required for your size board.

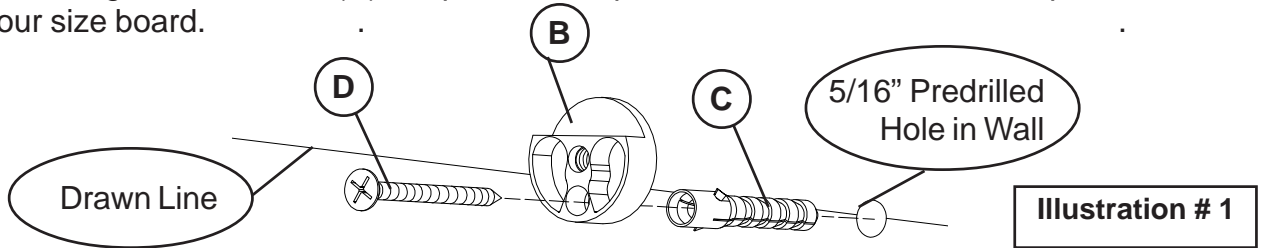

- 3a.) For sheet rock walls:

Screw in a Drywall Anchor (F) on the line that was drawn 3/8" below and 3/8" above the top and bottom edges of your new board. Place the bottom hole in the Wall Mount (B) on top of the Drywall Anchor (F) and attach using one CS Screw (D). Repeat this Step for each Wall Mount that is required for your size board.

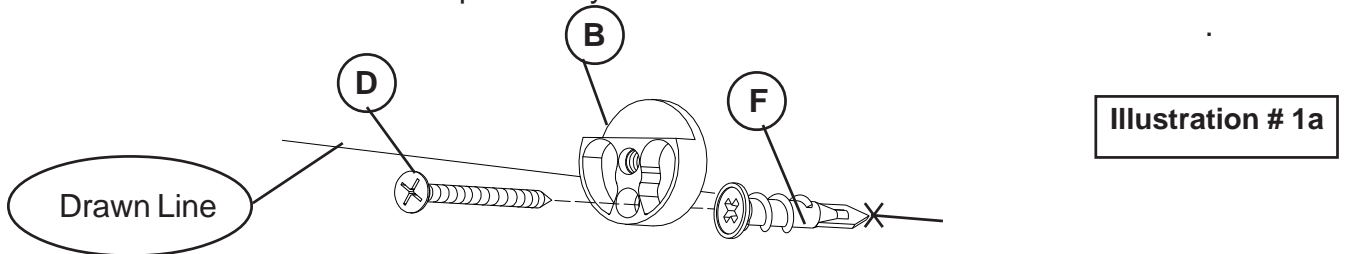

- 4.) Your attached Wall Mounts (B) should be turned as shown in Illustration #2.

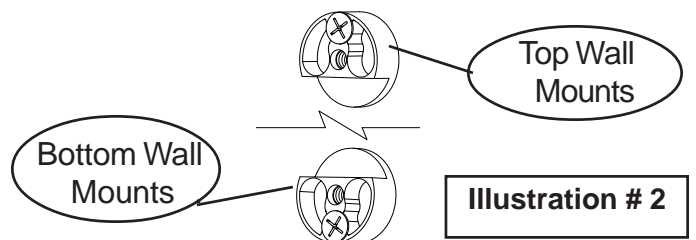

- 5.) Place the Glass Board (P1) between and resting on the step ledge on each Wall Mount (B). Secure the Glass Board (P1) in place by screwing in a Top Cap (A) into each treaded hole in the Wall Mounts (B) as shown in Illustration #3

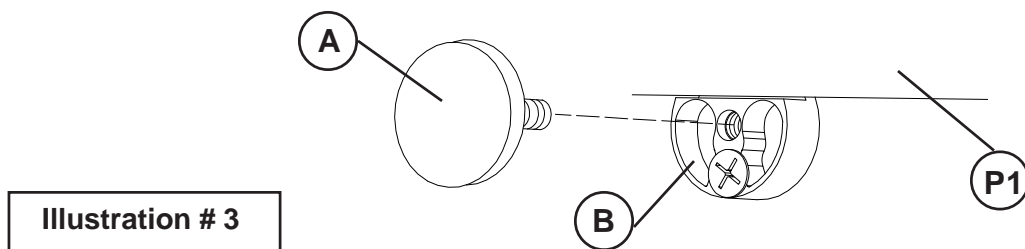

Follow These Instructions to Install the Glass Tray

- 1.) After the board has been installed, pick the location that you would like your tray to be installed.
Mark a line at least 1" down from the bottom of the board. Make sure your location will not interfere with the bottom Mounts that are holding the board.
- 2.) Place the Glass Tray (P-2) on the line and mark the right and left edges of the tray on the line.
Measure in 1" from the edge marks of the tray and make your marks.
- 3.) Predrill two 5/16" diameter holes at your marked points below the Glass Board on the wall.
Push in a Plastic Anchor (C) in each hole. Attach a Glass Tray Mount (E) over the Plastic Anchor (C) using one CS Screw (D) for each mount.

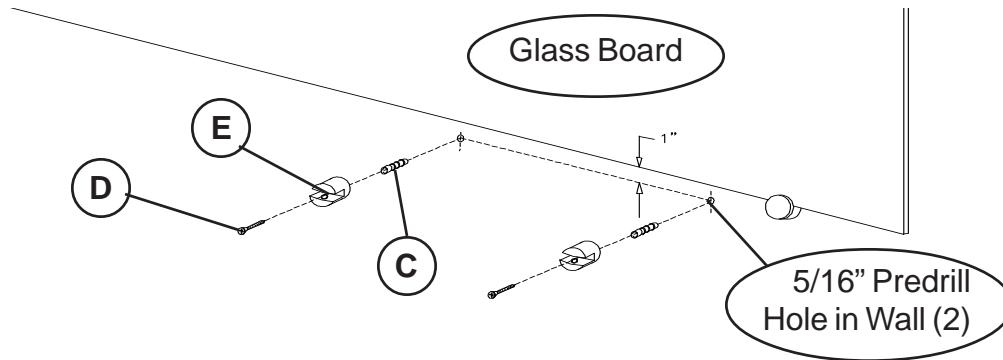

For Drywall :

- 3a.) Screw in a Drywall Anchor (F) at each of your marked points below the Glass Board on the wall.
Attach a Glass Tray Mount (E) over the Drywall Anchor (F) using one CS Screw (D) for each mount.

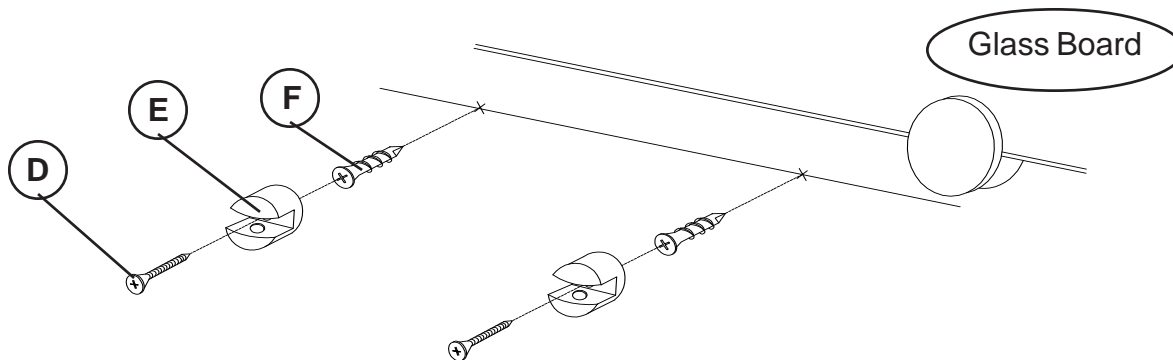

- 4.) Slide in the Glass Tray (P-2) into the slots of the Glass Tray Mounts (E) and secure in place by tightening the plastic set screws in the bottom flange of each mount, as shown in illustration #2.

