

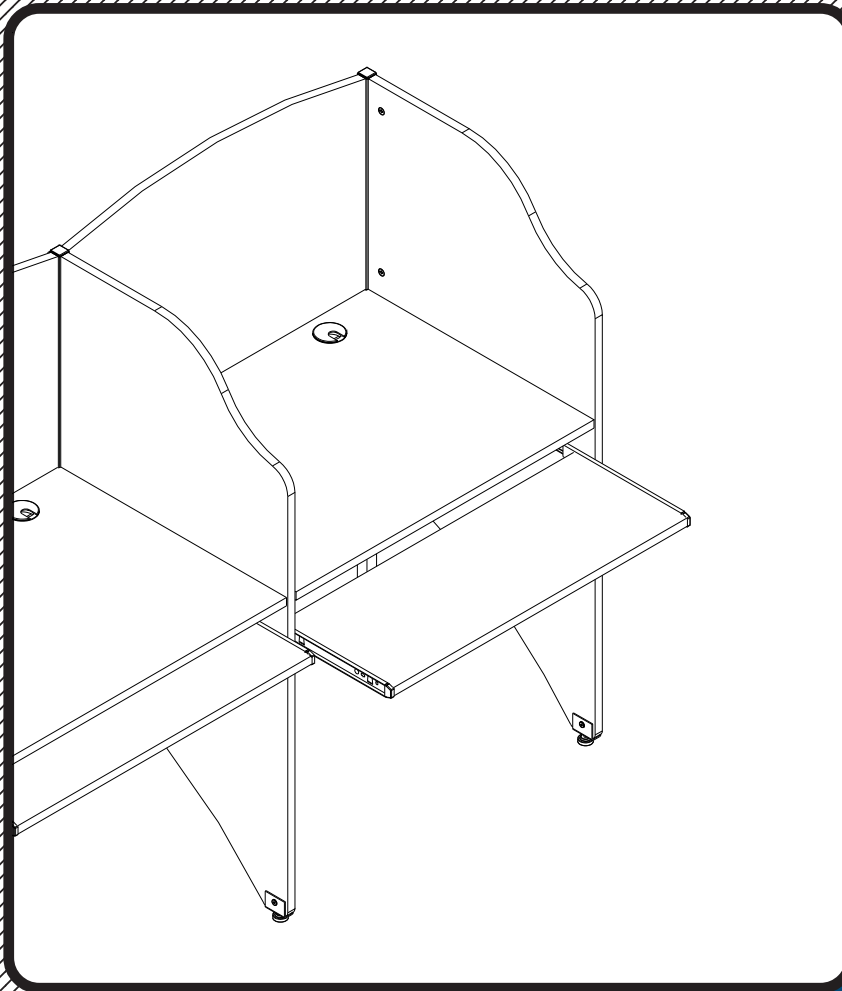











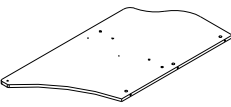

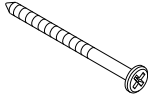



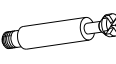







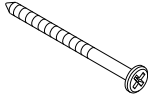



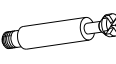





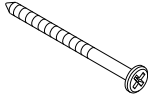

#89869 Add-On Floor Carrel

Teak HP Laminate

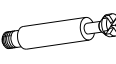

Assembly Instructions

#89869 Add-On Floor Carrel

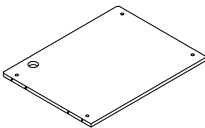
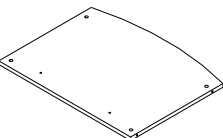
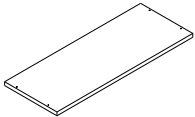
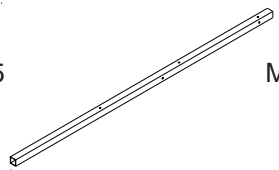
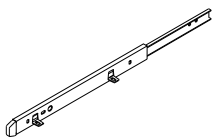
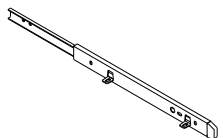
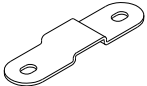
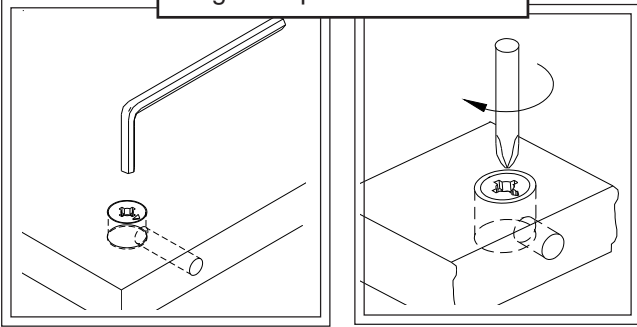
Part	Drawing	Description	Qty	Part	Drawing	Description	Qty																																																				
P-1		Middle Side Panel	1 EA	<h3 style="text-align: center;">Hardware List</h3> <table border="0"> <tr> <td>A</td> <td></td> <td>Socket Screw M5X15 mm</td> <td>1 EA</td> </tr> <tr> <td>A1</td> <td></td> <td>Wood Screw #6X1/2</td> <td>12 EA</td> </tr> <tr> <td>A2</td> <td></td> <td>Wood Screw #8X2 1/4</td> <td>2 EA</td> </tr> <tr> <td>B</td> <td></td> <td>Interior Threaded Post</td> <td>1 EA</td> </tr> <tr> <td>B1</td> <td></td> <td>Washer</td> <td>4 EA</td> </tr> <tr> <td>C</td> <td></td> <td>Cam Lock</td> <td>11 EA</td> </tr> <tr> <td>D</td> <td></td> <td>Cam Post</td> <td>11 EA</td> </tr> <tr> <td>E</td> <td></td> <td>Wood Dowel</td> <td>4 EA</td> </tr> <tr> <td>F</td> <td></td> <td>Glide Bracket</td> <td>1 EA</td> </tr> <tr> <td>G</td> <td></td> <td>Glide</td> <td>2 EA</td> </tr> <tr> <td>H</td> <td></td> <td>Grommet Sleeve</td> <td>1 EA</td> </tr> <tr> <td>J</td> <td></td> <td>Grommet Cap</td> <td>1 EA</td> </tr> <tr> <td>K</td> <td></td> <td>Allen Wrench</td> <td>1 EA</td> </tr> </table>				A		Socket Screw M5X15 mm	1 EA	A1		Wood Screw #6X1/2	12 EA	A2		Wood Screw #8X2 1/4	2 EA	B		Interior Threaded Post	1 EA	B1		Washer	4 EA	C		Cam Lock	11 EA	D		Cam Post	11 EA	E		Wood Dowel	4 EA	F		Glide Bracket	1 EA	G		Glide	2 EA	H		Grommet Sleeve	1 EA	J		Grommet Cap	1 EA	K		Allen Wrench	1 EA
A		Socket Screw M5X15 mm	1 EA																																																								
A1		Wood Screw #6X1/2	12 EA																																																								
A2		Wood Screw #8X2 1/4	2 EA																																																								
B		Interior Threaded Post	1 EA																																																								
B1		Washer	4 EA																																																								
C		Cam Lock	11 EA																																																								
D		Cam Post	11 EA																																																								
E		Wood Dowel	4 EA																																																								
F		Glide Bracket	1 EA																																																								
G		Glide	2 EA																																																								
H		Grommet Sleeve	1 EA																																																								
J		Grommet Cap	1 EA																																																								
K		Allen Wrench	1 EA																																																								
P-2		Top Panel	1 EA																																																								
P-3		Back Panel	1 EA																																																								
P-4		Keyboard Panel	1 EA																																																								
P-5		Middle Leg	1 EA																																																								
P-6		Left Keyboard Slide	1 EA																																																								
P-7		Right Keyboard Slide	1 EA																																																								
P-8		Ganging Bracket	2 EA																																																								
<div style="border: 1px solid black; padding: 5px; width: fit-content; margin: 0 auto;"> <p>Note: Camlocks can be turned with Allen Wrench, or Large Phillips Screwdriver</p> </div>				<p>Tools required: Phillips Head Screwdriver</p>																																																							
																																																											

#89869 Add-on Floor Carrel

Assembly Diagram

To Assemble:

Identify and Separate all the Parts and Hardware.

1. Remove Keyboard from #89830 Carrel as shown in illustration # 1a. Remove left leg Assembly from #89830 Carrel as shown in illustration # 1b.

Illustration # 1a

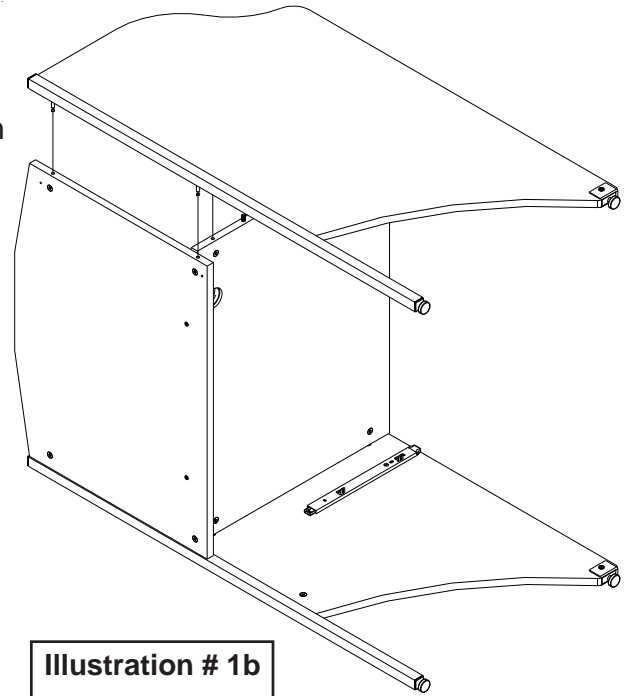
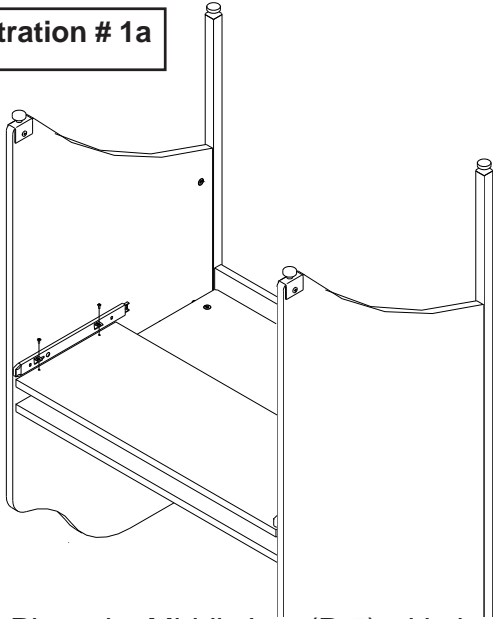

Illustration # 1b

2. Place the Middle Leg (P-5) with the three threaded holes facing up. Install 7 Cam Posts (D) in Leg as shown in illustration # 2.
3. Install 1 Leveling Glide (G) in the bottom of leg as shown in illustration # 2.
4. Tighten Cam Posts (D) using Phillips Screwdriver.

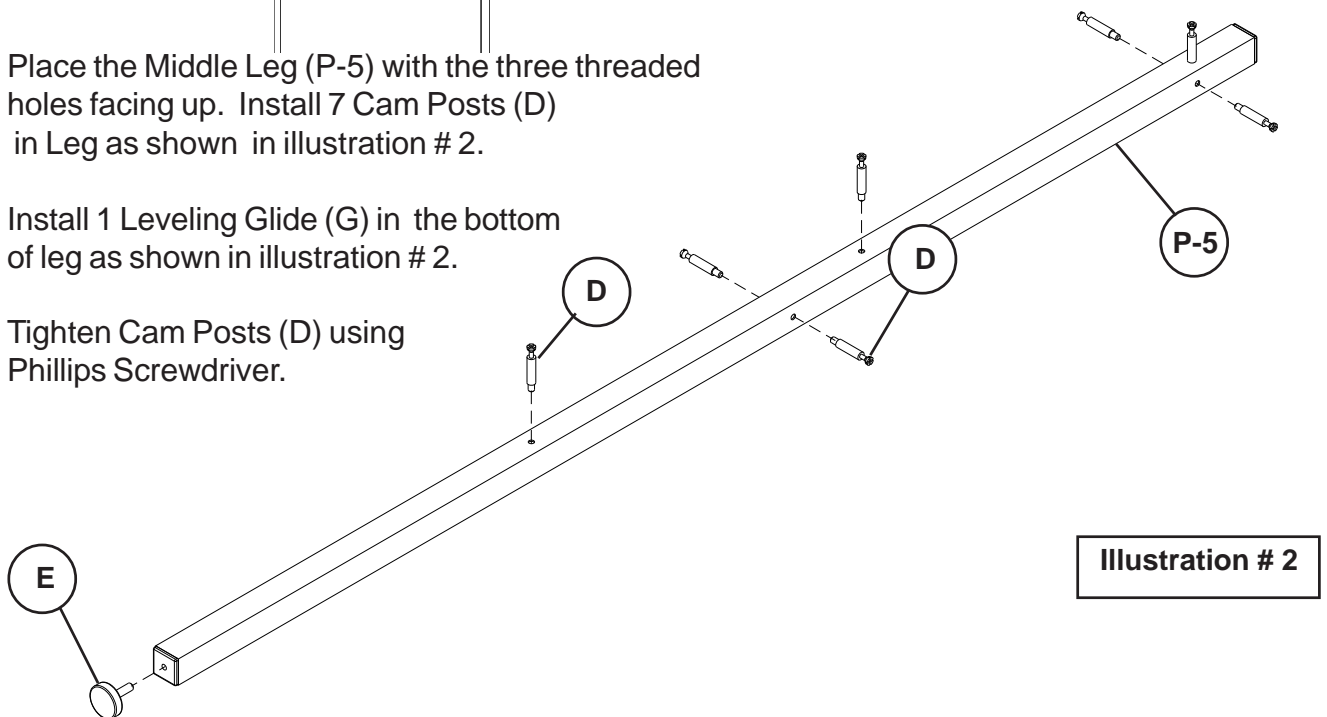

Illustration # 2

Do not use unless all screws are tight. At least every six months, check all screws to be sure they are tight. If parts are missing, broken, damaged, or worn, stop use of the product until repairs are made by your dealer using factory authorized parts.

5. Place the Middle Side Panel (P-1) with the Camlocks(C) facing up and install 2 each Cam Posts (D) in the 2 threaded insert nuts (Pre-installed) as shown in illustration # 3.

6. Install 2 each Dowels (E) into the holes as shown in illustration # 3.

7. Attach Middle Side Panel (P-1) to Middle Leg (P-5) as shown in illustration # 3. Secure by turning the Cam Locks (C) 1/4 turn until they lock.

8. Attach Left Keyboard Slide (P-6) to the Middle Side Panel (P-1) using 2 each Screws (A1) as shown in illustration #3.

9. Attach 1 Glide Bracket (F) using 1 Socket Screws (A) and 1 Interior Threaded Posts (B) as shown in illustration #3. Tighten Screws using Phillips Screwdriver.

10. Insert 1 Glide (G) into the Glide Bracket (F) as shown in illustration #3.

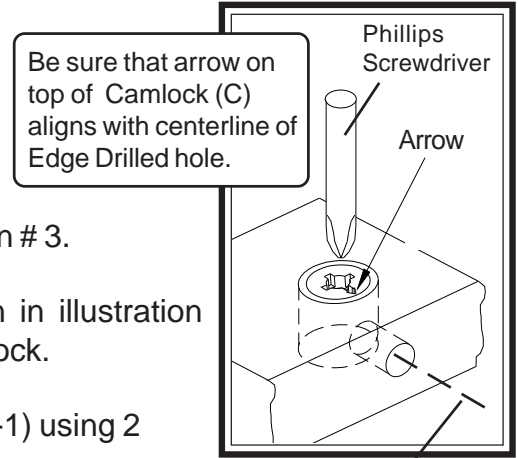

Centerline of Edge Drilled hole.

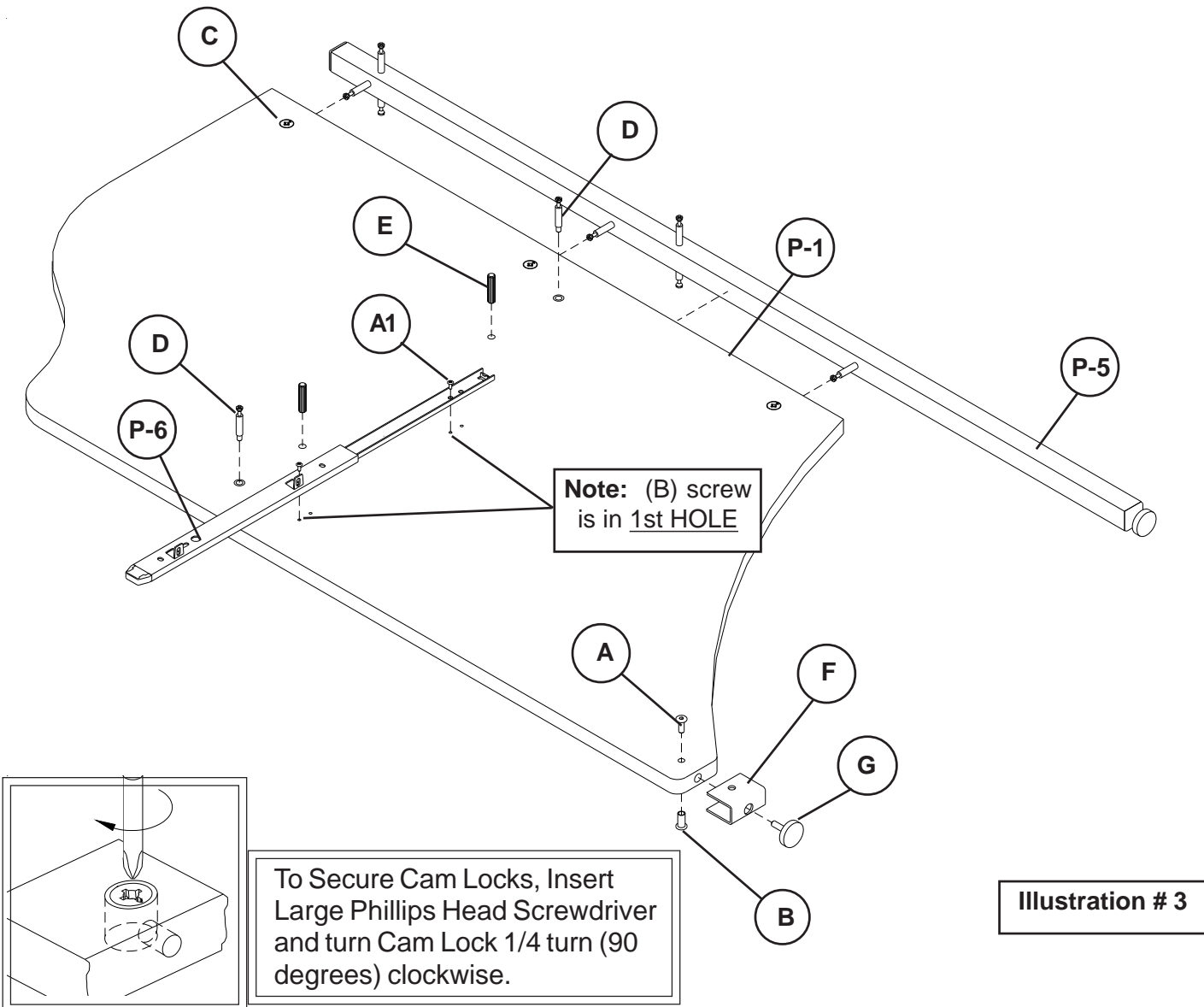

**Should you require assistance
during assembly, please call our
Customer Service Department
Monday - Friday 8 a.m. - 5 p.m.
Central Standard Time
Toll-Free Customer Service
1-800-749-2258**

11. Install 2 each Dowels (E) into the holes as shown in illustration # 3.
12. Turn the Middle Side Panel (P-1) over and install 2 each Cam Posts (D) in the 2 threaded insert nuts (Pre-installed) as shown in illustration # 4.
13. Attach Right Keyboard Slide (P-7) to the Middle Side Panel (P-1) using 2 each Screws (A1) as shown in illustration #4.

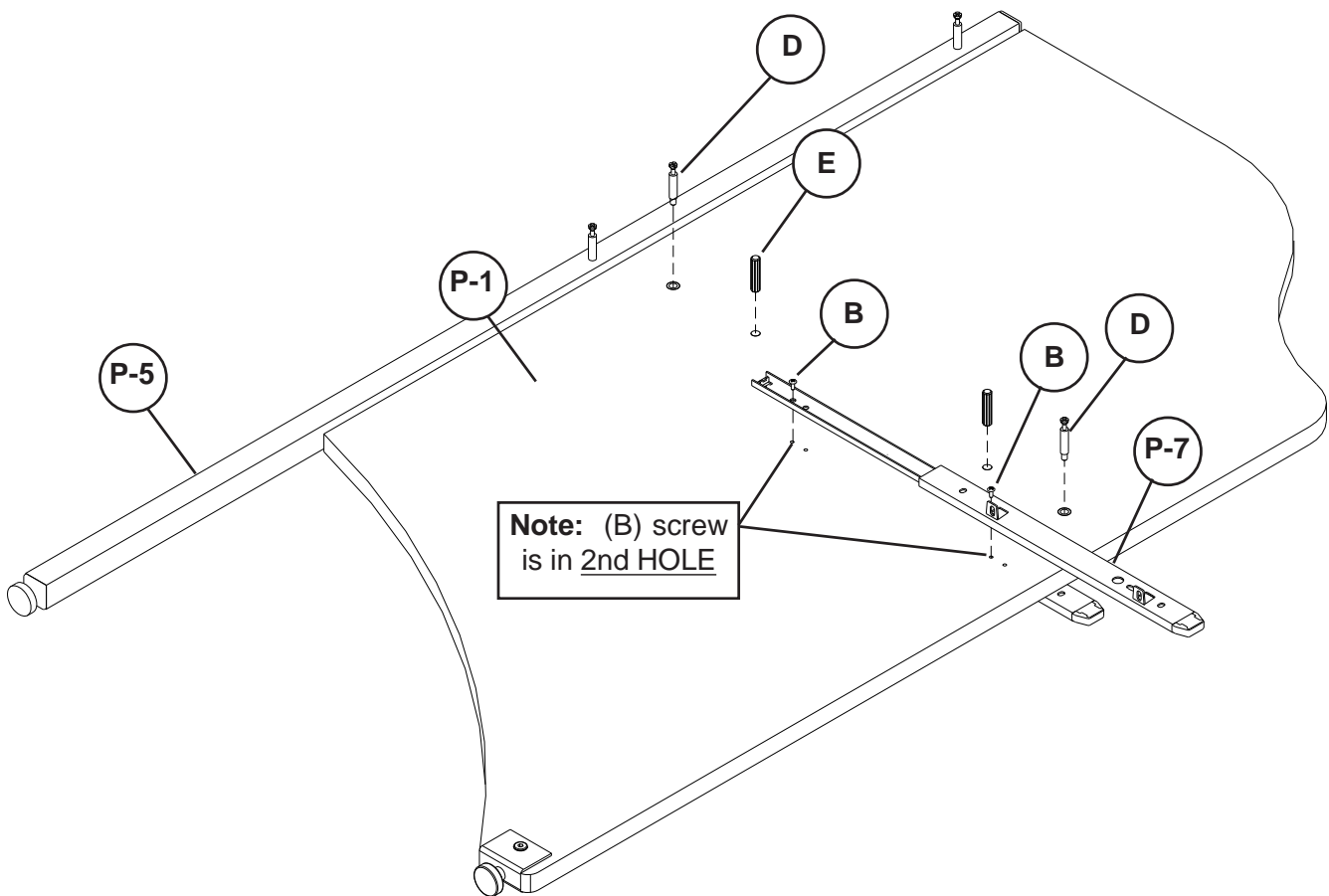
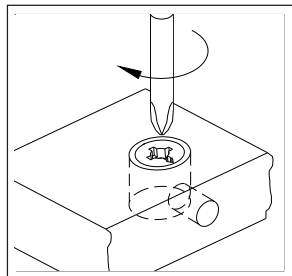

Illustration # 4

14. Attach Middle Side Panel (P-1) to Top Panel and the Middle Leg (P-5) to the Back Panel of #89830 Carrel as shown in illustration # 5.

15. Secure by turning the Cam Locks (C) 1/4 turn until they lock.



To Secure Cam Locks, Insert Large Phillips Head Screwdriver and turn Cam Lock 1/4 turn (90 degrees) clockwise.

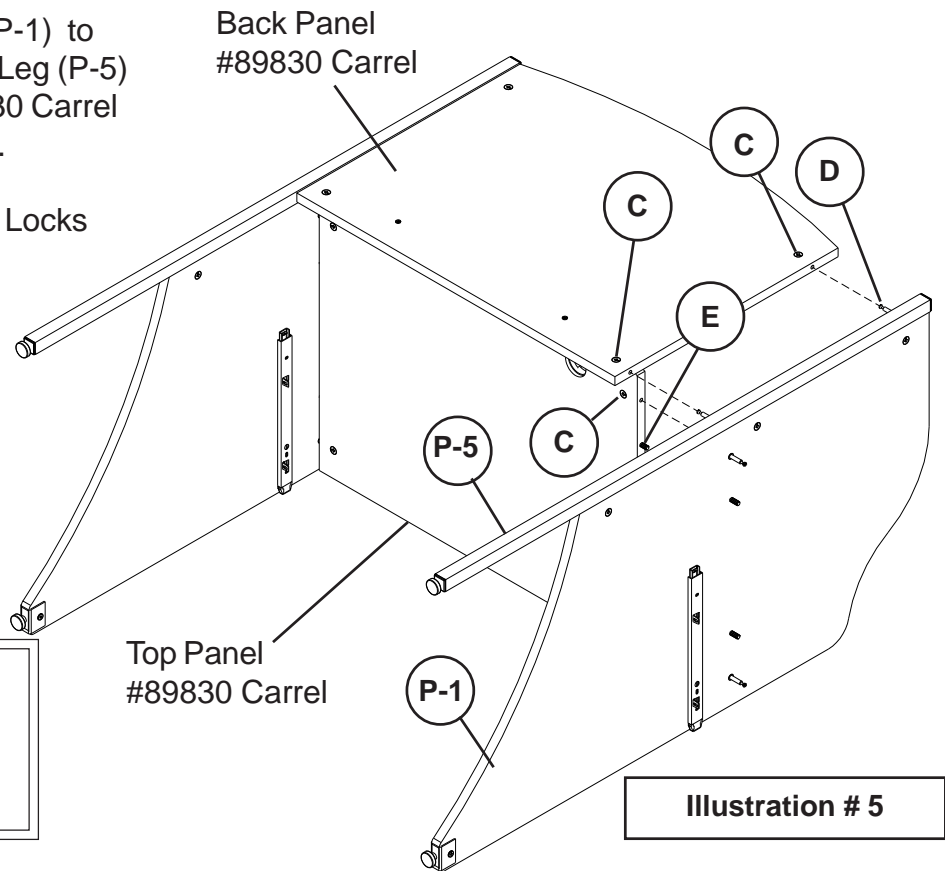

Illustration # 5

16. Slide Top Panel (P-2) over the Wood Dowels (E) and the Camposts (D) in the Middle Side Panel (P-1) as shown in illustration #6. Secure by turning the Cam Locks (C) 1/4 turn until they lock.

17. Slide Back Panel (P-3) over the Camposts (D) in the Middle Leg (P-5) as shown in illustration # 6. Secure by turning the Cam Locks (C) 1/4 turn until they lock.

18. Secure Back Panel (P-3) to Top Panel (P-2) using 2 Wood Screws (A2) as shown in illustration # 6. Tighten Screws using Phillips Screwdriver.

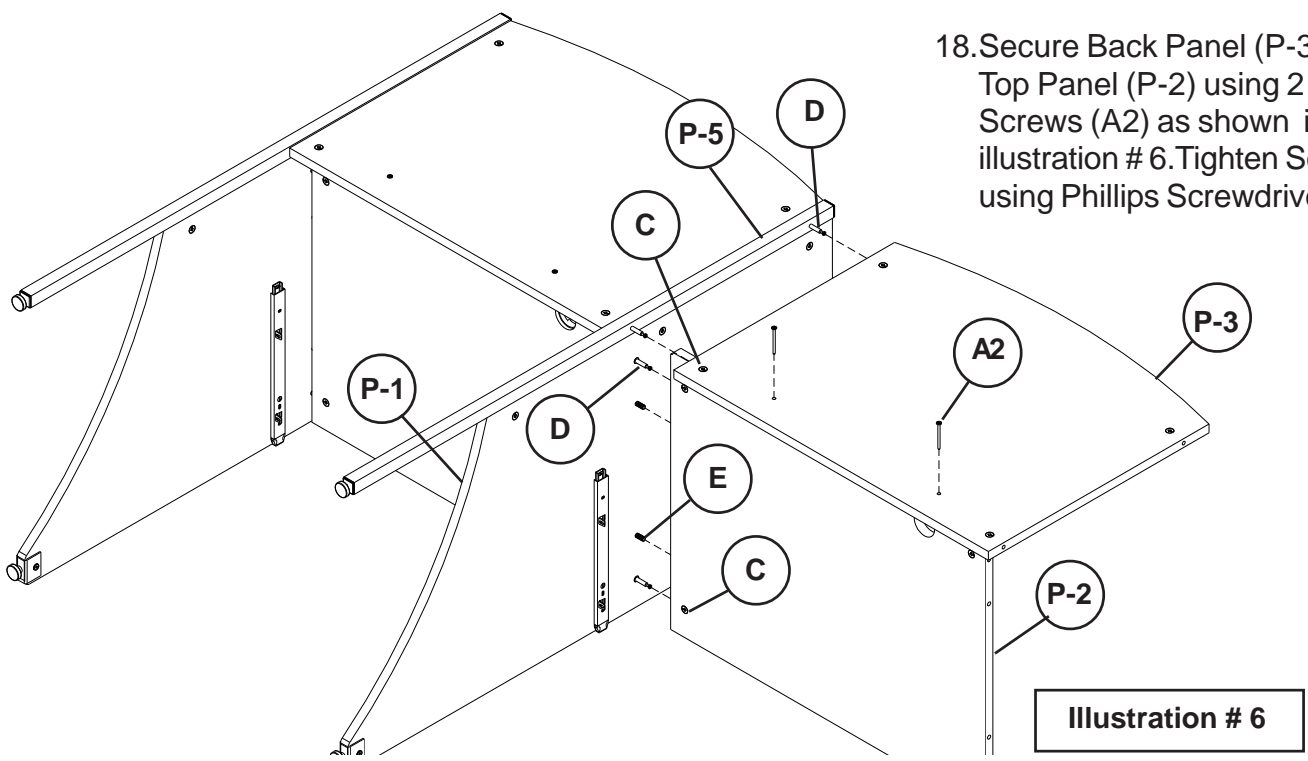
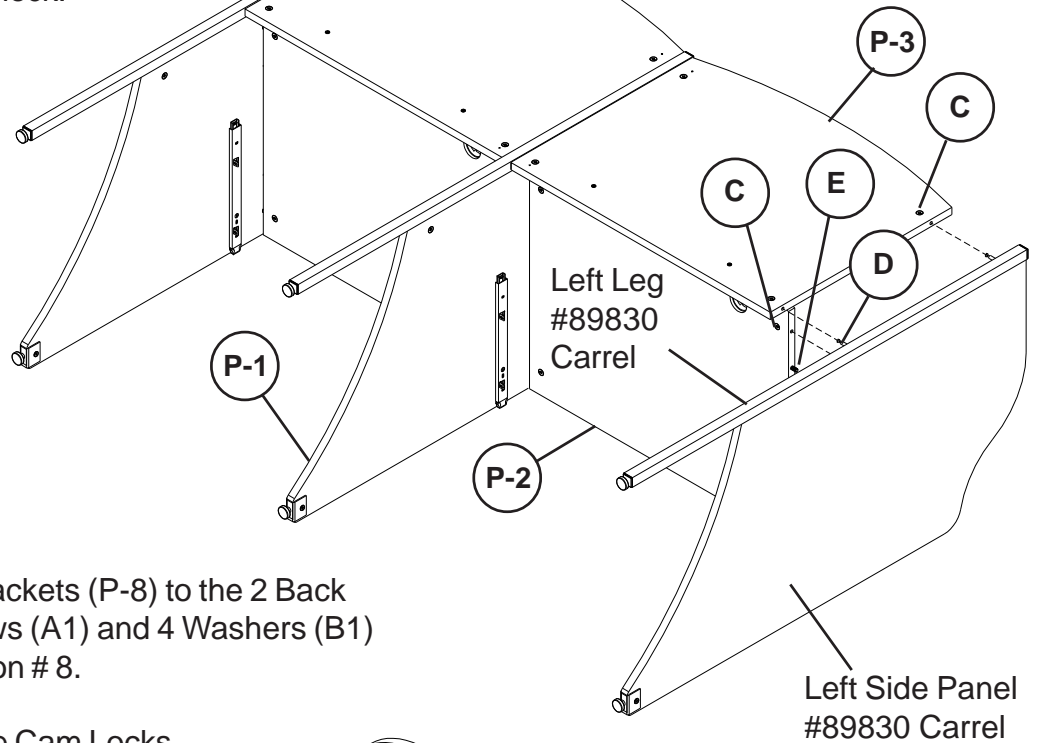

Illustration # 6

19. Attach Left Side Panel and Left Leg from #89830 Carrel to Top Panel (P-2) and Back Panel (P-3) as shown in illustration # 7.

Illustration # 7

20. Secure by turning the Cam Locks (C) 1/4 turn until they lock.



21. Attach 2 Ganging Brackets (P-8) to the 2 Back Panels using 4 Screws (A1) and 4 Washers (B1) as shown in illustration # 8.

22. Secure by turning the Cam Locks (C) 1/4 turn until they lock.

Illustration # 8

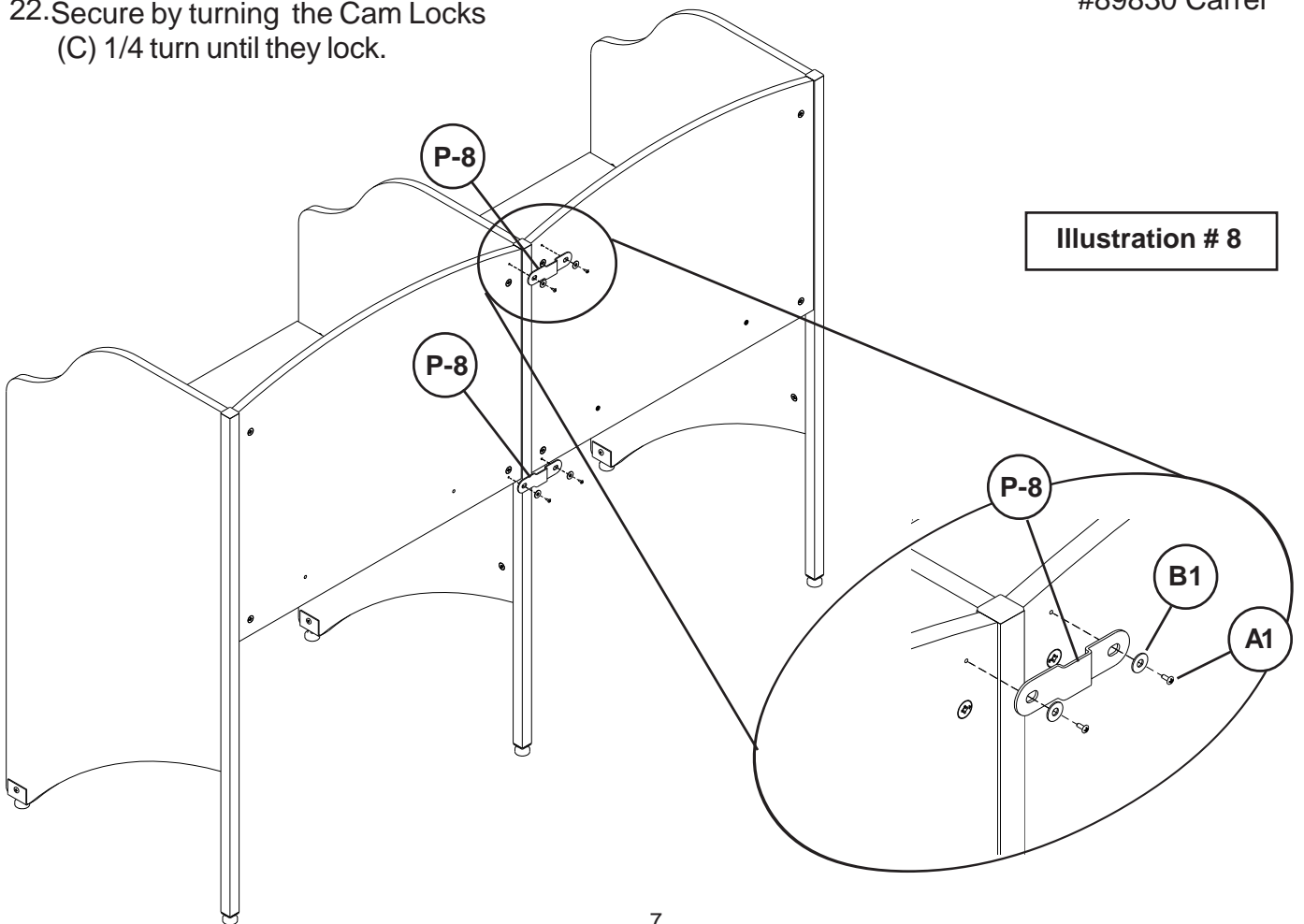

23. Attach 1 Keyboard (P-4) and 1 keyboard from #89830 to Left Keyboard Slides (P-8) and Right Keyboard Slides (P-9) using 4 Wood Screws (A1) and 4 Wood Screws from #89830 as shown in illustration# 9.

24. Tighten Screws (A1) using Phillips Screwdriver.

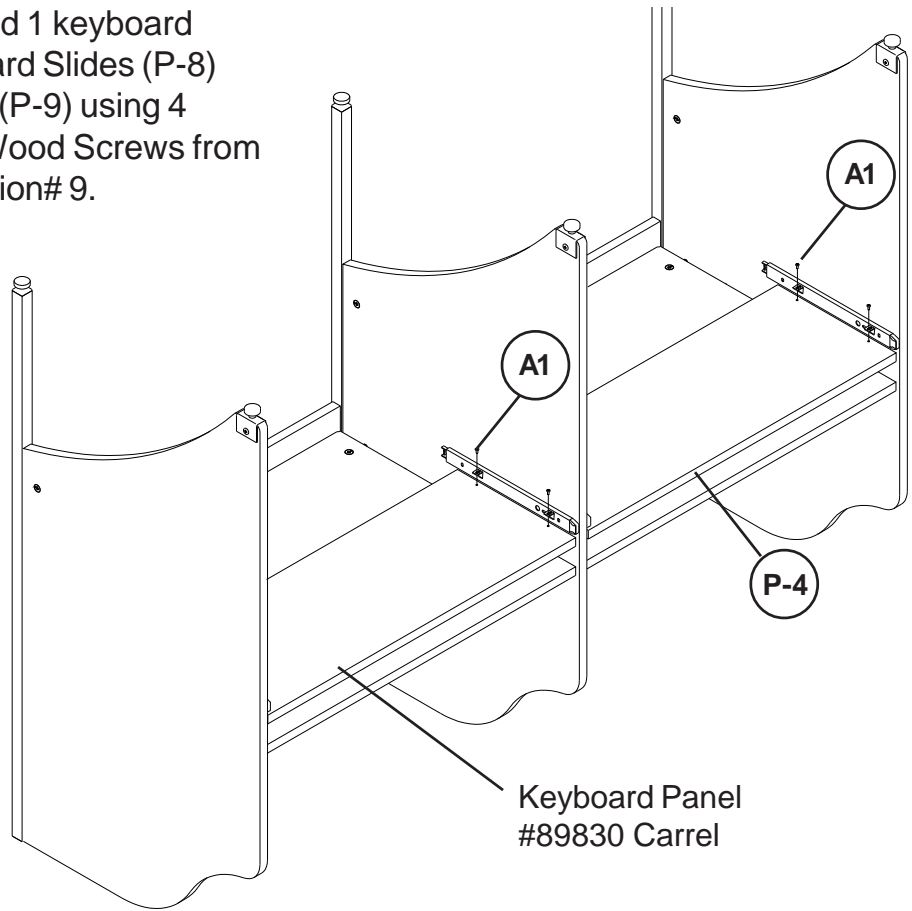
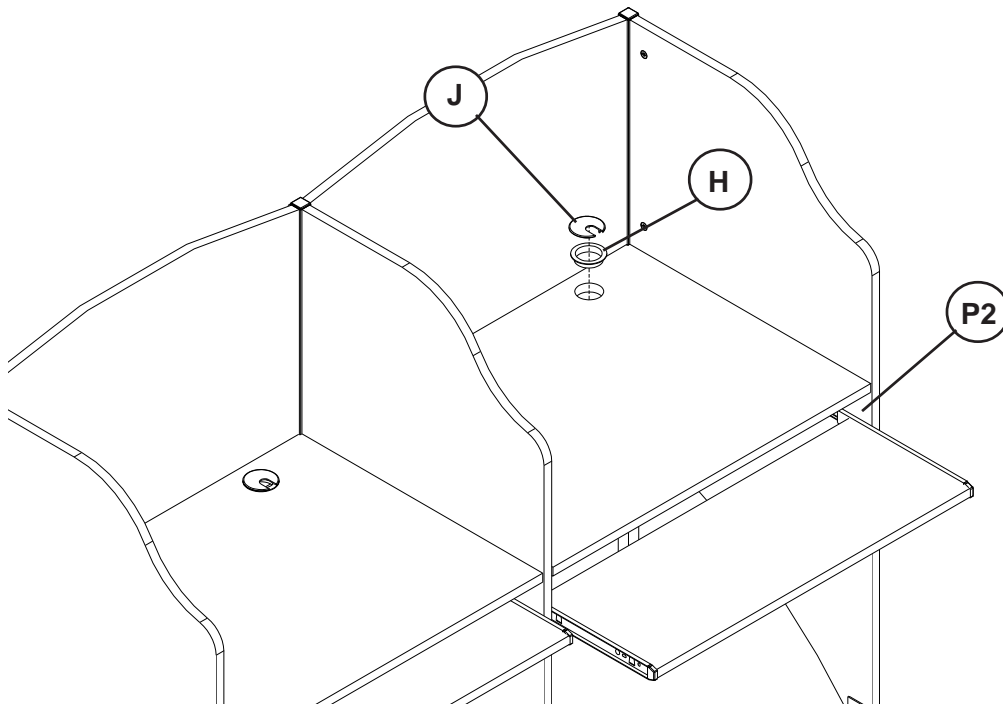

Illustration # 9
Keyboard Slide Assembly

To install Grommets:

25. Insert Grommet Sleeve (H) in Round opening in Top Platform (P-2) as shown in illustration #10.

26. Snap Grommet Cap (J) into Grommet Sleeve (H) as shown in illustration #10.



Grommet installation
Illustration #10