

# Harmony GTO ATEX/IECEX Instruction Guide

www.se.com

Concerning the use of Harmony GTO graphic terminals for applications in potentially explosive atmospheres (Zones 2/22)

Schneider Electric

8<sup>ème</sup> rue, ZI Carros 06516 Carros  
cedex – France

**Type examination certificate: INERIS 12ATEX3007X**  
**IECEX Certificate of Conformity: IECEX INE16.0057X**

## SAFETY INSTRUCTIONS

Read these instructions carefully, and look at the equipment to become familiar with the device before trying to install, operate, or maintain it. The following special messages may appear throughout this documentation or on the equipment to warn of potential hazards or to call attention to information that clarifies or simplifies a procedure.



The addition of this symbol to a “Danger” or “Warning” safety label indicates that an electrical hazard exists, which will result in personal injury if the instructions are not followed.



This is the safety alert symbol. It is used to alert you to potential personal injury hazards. Obey all safety messages that follow this symbol to avoid possible injury or death.



# DANGER

**DANGER** indicates a hazardous situation which, if not avoided, **will result in** death or serious injury.



\* H R B 4 3 2 7 8 0 4 \*

The information in this document is subject to change without notice.

Copyright © 5/2020 Schneider Electric

All Rights Reserved.

HRB43278 04

Printed in

**Schneider**  
Electric

---

## **WARNING**

**WARNING** indicates a hazardous situation which, if not avoided, **could result in** death or serious injury.

## **CAUTION**

**CAUTION** indicates a hazardous situation which, if not avoided, **could result in** minor or moderate injury.

## **NOTICE**

**NOTICE** is used to address practices not related to physical injury.

### **PLEASE NOTE**

Electrical equipment should be installed, operated, serviced, and maintained only by qualified personnel. No responsibility is assumed by Schneider Electric for any consequences arising out of the use of this material. A qualified person is one who has skills and knowledge related to the construction and operation of electrical equipment and its installation, and has received safety training to recognize and avoid the hazards involved.

### **SCOPE**

This present document applies when the Harmony GTO terminal bears  marking. They are supplied only with 24 Vdc. This documentation has to be kept and always refer to those instructions for installation, operation, maintenance or evolution of your system. You can download this instruction guide at [www.se.com](http://www.se.com).

If any translation is needed, you can contact your local Schneider support or sales center.

---

---

## Relevant Standards

---

The product have been manufactured in accordance with:

- Standard EN 60079-0 (2018) and IEC 60079-0 (2017): Explosive atmospheres - Part 0: Equipment - General requirements.
- Standard EN 60079-15 (2010) and IEC 60079-15 (2010): Explosive atmospheres - Part 15: Equipment protection by type of protection “n”.
- Standard EN 60079-31 (2014) and IEC 60079-31 (2013): Explosive atmospheres - Part 31: Equipment dust ignition protection by enclosure “t”.



# DANGER

### POTENTIAL FOR EXPLOSION

Install, use, and maintain the product in accordance with:

- Standard IEC 60079-14: Explosive atmospheres - Part 14: Electrical installations design, selection and erection.
- Standard EN 60079-17: Inspection and maintenance of electrical installations in hazardous areas.
- Edicts, by-laws, laws, directives, circulars, standards, regulations and any other document relating to where the apparatus is installed.

**Failure to follow these instructions will result in death or serious injury.**

---

## Permitted zones of application

---

Refer to the section "Markings" to get information about the permitted zones of protection and the types of protection.

- Harmony GTO terminals installed in zones 2/22 hazardous areas must be certified and bear the  marking
- Ensure with the marking that the terminals are compatible with the conditions permitted for the hazardous area at the site where it is being used.

---

---

## Installation, Operation and Maintenance

---

Make sure you follow all the recommendations in the Harmony GTO Quick Reference Guide and additionally those listed below.



### DANGER

#### POTENTIAL FOR EXPLOSION

- Confirm that the location is free from explosively hazardous gases or dust before connecting or disconnecting equipment, replacing or wiring modules.
- The service temperature in the suitable enclosure must not exceed 50°C or 55°C (refer to marking).
- Confirm each interface (COM1, COM2, LAN), field wiring terminal blocks and the SD Card / Battery Cover have been securely locked.
- Confirm USB cables are attached with its appropriate clamp.
- Install the product in an enclosure EPL Gc insuring a minimal ingress protection IP54 for use in zone 2 and in an enclosure EPL Dc insuring a minimal ingress protection IP6x for use in zone 22.
- Make sure the purging test inside the product is performed and validated in accordance with IEC 60079-2 when installed in an IP4X pressurized enclosure.
- Do not install the product in the environment more than pollution degree 2 as defined in IEC 60664-1.
- Do not open the enclosure while the system is powered up.
- Confirm that the power supply has been turned OFF before disconnecting, replacing or wiring modules.
- Ensure that the FG (Functional Ground) on the power supply is properly connected to ground.
- Ensure the Stainless Bezel Part (for HMIGTOxx15) is properly connected to ground.
- Use only screw fasteners suitable for installations in explosive atmospheres.
- Do not use damaged equipment.
- Use Touch Pen XBTZGPEN on all Harmony GTO used in zone 2 and zone 22 areas to avoid the risk of electrostatic discharges.
- Protect the terminal against accidental shocks.

**Failure to follow these instructions will result in death or serious injury.**



## CAUTION

### **ENVIRONMENTAL HAZARDS TO THE EQUIPMENT**

- Do not allow layers of dust to form on Harmony GTO terminals. Clean the terminal regularly.
- Ensure that Harmony GTO terminals are installed according to its manufacturer's specifications.

**Failure to follow this instruction can result in injury or equipment damage.**

---

---

## Ground Connection

---

Metal part for HMIGTO6315, HMIGTO5315, HMIGTO2315 should be connected to ground.



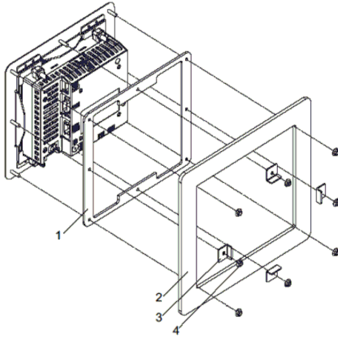



When installed in a metal cabinet or enclosure, the contact point shall be paint free and metal cabinet or enclosure should be grounded.



- 1 Gasket (Non-metal)
- 2 Panel (Metal)
- 3 Brackets (Metal)
- 4 M4 Hex nuts (Metal)

## Markings

ATEX and IECEx markings, applied to the Harmony GTO terminals are as follows:

<p><b>Models:</b> HMIGTO6315, HMIGTO6310, HMIGTO5315, HMIGTO5310, HMIGTO4310, HMIGTO2315, HMIGTO2310</p>	<p><b>Models:</b> HMIGTO2300, HMIGTO1310, HMIGTO1300, HMIGTO3510</p>
<p>Schneider Electric F-06516 Carros</p> <p>  </p> <p>INERIS 12ATEX3007X IECEX INE 16.0057X II 3 G D Ex nA nC IIC T5 Gc Ex tc IIIC T100°C Dc Tamb: 0°C to +55°C</p> <p>WARNING - Do not disconnect when circuit is live. - Potential electrostatic charging hazard (see instructions).</p>	<p>Schneider Electric F-06516 Carros</p> <p>  </p> <p>INERIS 12ATEX3007X IECEX INE 16.0057X II 3 G D Ex nA nC IIC T5 Gc Ex tc IIIC T100°C Dc Tamb: 0°C to +50°C</p> <p>WARNING - Do not disconnect when circuit is live. - Potential electrostatic charging hazard (see instructions).</p>
<p><b>NOTE:</b> Other required elements such as product reference, serial number and date code of manufacture are already marked on products. All models may be followed by alphanumeric characters and there is no impact safety related critical components and constructions.</p>	

## EU DECLARATION OF CONFORMITY

We: Schneider Electric Industries SAS  
35 rue Joseph Monier  
F-92506 Rueil Malmaison

Hereby declare under our sole responsibility that the products:

Trademark	<b>Harmony or Magelis</b>
Product, Type	<b>Human Machine Interface</b> <b>HMIGTO:</b> HMIGTO1300, HMIGTO1310, HMIGTO2300, HMIGTO2310, HMIGTO2315, HMIGTO3510, HMIGTO4310, HMIGTO5310, HMIGTO5315, HMIGTO6310, HMIGTO6315 Includes models with additional alphanumeric characters at the end of the model number.
List of reference and options	See the Harmony GTO ATEX/IECEx Instruction Guide

Are in conformity with the requirements of the following directives and conformity was checked in accordance with the following standards.

Directive	Harmonized standard / Notified body reference
ATEX Directive 2014/34/EU	EN 60079-0: 2018 (**), EN 60079-15: 2010, EN 60079-31: 2014
(*) According to art 41.2, certificates issued under Directive 94/9/EC shall be valid under this directive. (**) After examination, the above products are not impacted by major changes of this new edition.	<b>EC Type examination certificate:</b> INERIS 12ATEX3007X (*) and IECEx INE 16.0057X II 3 G D  Ex nA nC IIC T5 Gc Ex tc IIIC T100°C Dc Tamb: 0°C to +50°C / +55°C By INERIS: Parc Technologique ALATA, 60550 Verneuil en Halatte - France

Subject to correct installation, maintenance and use conforming to its intended purpose, to the applicable regulations and standards, to the supplier's instructions and to accepted rules of the art. This declaration becomes invalid in the case of any modification to the products not authorized by us.

Compliance with the ATEX Directives will require the application of ATEX guide giving requirements, details and advices for installation of products used. The guides are available on [www.se.com](http://www.se.com)

**Issued at Carros - FRANCE: May 21st, 2020**



Name: Serge RUGO  
Digital Plant  
Certification Manager