



00175569919091

Altivar - Lexium

VW3A4551...565, 568...572

VW3A4551	10 mH - 4 A
VW3A4552	4 mH - 10 A
VW3A4553	2 mH - 17 A
VW3A4554	1 mH - 31 A
VW3A4555	0,5 mH - 60 A
VW3A4556	0,3 mH - 107 A
VW3A4557	0,15 mH - 230 A
VW3A4558	0,155 mH - 184 A
VW3A4559	0,12 mH - 222 A
VW3A4560	0,098 mH - 264 A
VW3A4561	0,066 mH - 344 A
VW3A4562	0,049 mH - 455 A

VW3A4563	0,038 mH - 540 A
VW3A4564	0,038 mH - 613 A
VW3A4565	0,032 mH - 720 A
VW3A4568	0,085 mH - 300 A
VW3A4569	0,060 mH - 450 A
VW3A4570	0,22 mH - 160 A
VW3A4571	0,23 mH - 230 A
VW3A4572	0,1 mH - 450 A

DANGER

HAZARD OF ELECTRIC SHOCK, EXPLOSION, OR ARC FLASH

- Only appropriately trained persons who are familiar with and understand the contents of this manual and all other pertinent product documentation and who have received safety training to recognize and avoid hazards involved are authorized to work on and with this drive system. Installation, adjustment, repair and maintenance must be performed by qualified personnel.
 - The system integrator is responsible for compliance with all local and national electrical code requirements as well as all other applicable regulations with respect to grounding of all equipment.
 - Many components of the product, including the printed circuit boards, operate with mains voltage. Do not touch. Use only electrically insulated tools.
 - Do not touch unshielded components or terminals with voltage present.
 - Motors can generate voltage when the shaft is rotated. Prior to performing any type of work on the drive system, block the motor shaft to prevent rotation.
 - AC voltage can couple voltage to unused conductors in the motor cable. Insulate both ends of unused conductors of the motor cable.
 - Do not short across the DC bus terminals or the DC bus capacitors or the braking resistor terminals.
 - Before performing work on the drive system:
 - Disconnect all power, including external control power that may be present.
 - Place a "Do Not Turn On" label on all power switches.
 - Lock all power switches in the open position.
 - Wait 15 minutes to allow the DC bus capacitors to discharge. The DC bus LED is not an indicator of the absence of DC bus voltage that can exceed 800 Vdc.
 - Measure the voltage on the DC bus between the DC bus terminals using a properly rated voltmeter to verify that the voltage is < 42 Vdc.
 - If the DC bus capacitors do not discharge properly, contact your local Schneider Electric representative.
 - Install and close all covers before applying voltage.
- Failure to follow these instructions will result in death or serious injury.**

Electrical equipment should be installed, operated, serviced, and maintained only by qualified personnel. No responsibility is assumed by Schneider Electric for any consequences arising out of the use of this product.

© 2013 Schneider Electric. All Rights Reserved.

VW3A4551 ... VW3A4553

IP 00

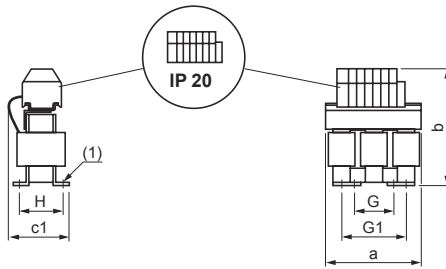

VW3	mm	a	b	c1	G	G1	H	(1)
A4551		100	135	60	40	60	42	8 x (Ø 6 x 9)
A4552		130	155	90	60	80,5	62	8 x (Ø 6 x 12)
A4553		130	155	90	60	80,5	62	8 x (Ø 6 x 12)

1 inch = 25,4 mm

VW3A4554 ... VW3A4555

IP 00

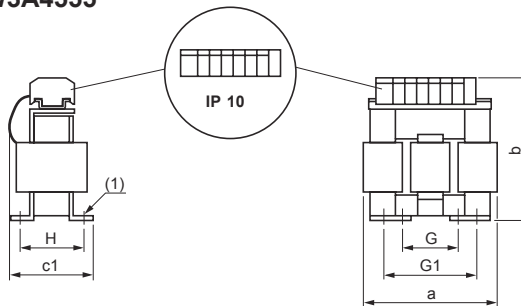

VW3	mm	a	b	c1	G	G1	H	(1)
A4554		155	170	135	75	107	90	8 x (Ø 6 x 12)
A4555		180	210	160	85	122	105	8 x (Ø 6 x 12)

1 inch = 25,4 mm

VW3A4556

IP 00

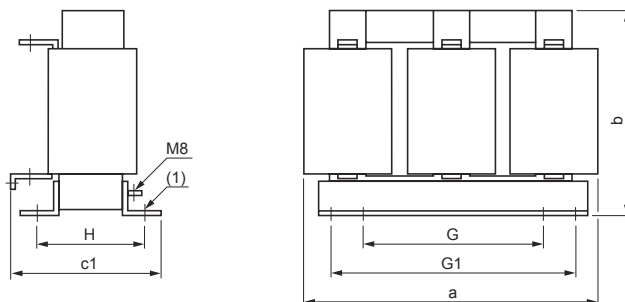

VW3	mm	a	b	c1	G	G1	H	(1)
A4556		270	210	180	105	181	100	8 x (Ø 1 1 x 22)

1 inch = 25,4 mm

VW3A4557

IP 00

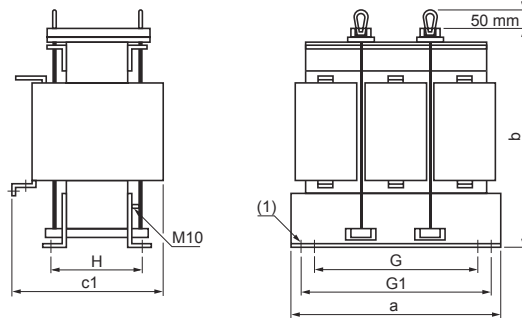

VW3	mm	a	b	c1	G	G1	H	(1)
A4557		320	290	215	190	230	142	8 x (Ø 11 x 22)

1 inch = 25,4 mm

VW3A4558 ... 572

IP 00

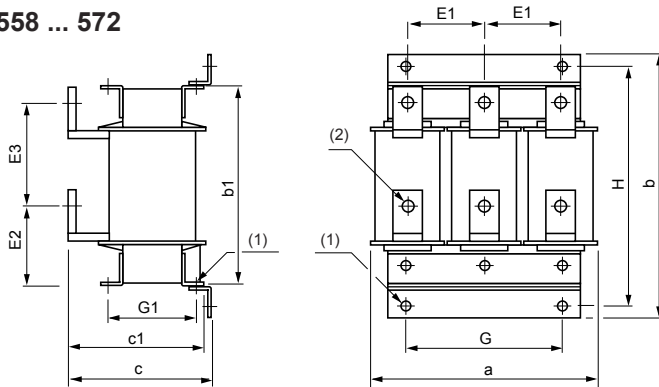

VW3	mm	a	b	b1	c	c1	G	G1	H	E1	E2	E3	(1)	(2)
A4558	280	330	300	210	200	200	200	125	300	90	115	80	Ø 9	Ø 10.5
A4559	320	380	300	210	200	225	120-160	350	100	80	150	150	Ø 11	Ø 11
A4560	320	380	300	210	200	225	150	350	100	86	150	150	Ø 11	Ø 11
A4561	320	380	300	250	230	225	145-175	350	100	86	150	150	Ø 11	Ø 13
A4562	320	380	300	250	230	225	150	350	100	86	150	150	Ø 11	Ø 13
A4563	320	380	300	250	230	225	150-165	350	100	86	150	150	Ø 11	Ø 13
A4564	385	440	340	265	245	300	125-165	400	120	130	190	190	Ø 13.5	2xØ 13
A4565	385	445	340	275	250	300	165	400	120	130	190	190	Ø 13.5	2xØ 13
A4568	320	385	300	210	200	225	140	340	100	80	150	150	Ø 11	Ø 11
A4569	320	385	300	250	230	225	170	340	100	86	150	150	Ø 11	Ø 13
A4570	280	305	240	210	200	200	125	275	90	90	100	100	Ø 9	Ø 8.5
A4571	385	440	340	265	245	300	115-150	400	120	85	190	190	Ø 13.5	Ø 13
A4572	385	440	340	305	295	300	175-205	400	120	85	190	190	Ø 13.5	Ø 13

1 inch = 25,4 mm

VW3A4551 ... 572

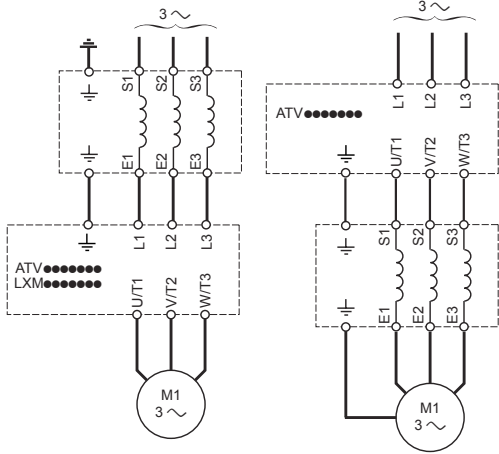

2 x VW3A4569 2 x VW3A4564

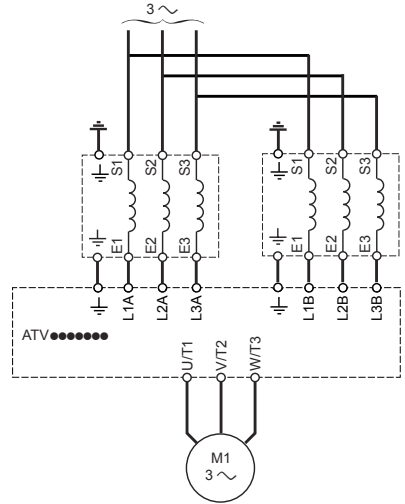

VW3A4551 ... 555

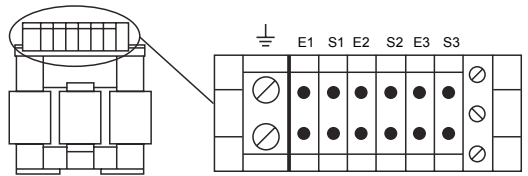

VW3A4556 ... 572

