



Cera-Notch

Grooving & Threading
System

■ **Versatility**

Universal grooving geometry is easily interchangeable with a wide variety of toolholders

■ **Variety**

Cermet, ceramic, carbide and coated carbide inserts available

NEW

PR1215

MEGACOAT Grade

For Heat-Resistant Alloys,
Alloy Steels, Stainless
Steels, and Cast Iron



**Made Exclusively
in the USA!**

MEGACOAT GRADES



Kyocera proprietary coating technology provides long tool life and stable machining in a variety of applications.

Physically harder than the ever-popular TiAlN coating with Oxidation resistance higher than TiAlN

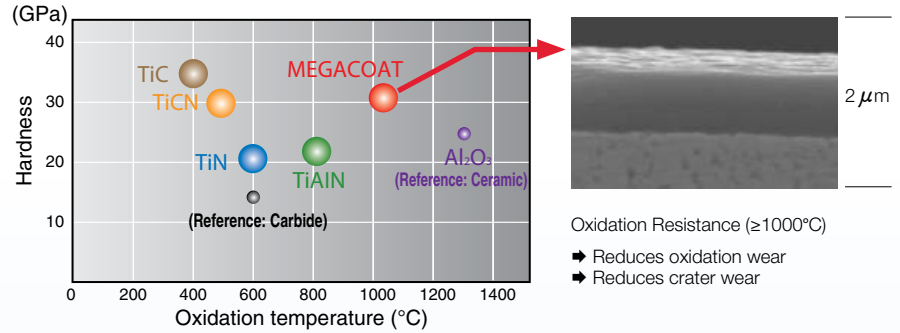

MEGACOAT GRADE PR1215 NEW

MEGACOAT PVD

Advantages

- Micro-grain carbide with metal binder is ideal for narrow grooving
- MEGACOAT coating maintains high hardness and promotes excellent oxidation resistance during high speed grooving
- Can be used for Heat-Resistant Alloys, Alloy Steels, Stainless Steels, and Cast Iron

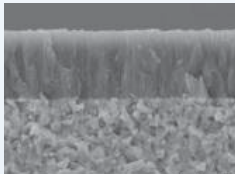

GROOVING WITH CERMETS

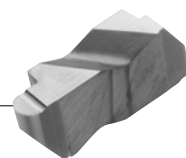

Advantages

- Offers better surface finish on carbon and alloy steel than coated carbides
- Higher cutting speeds than coated carbide are possible, reducing cycle times
- Cermets are ideal for light feeds and few interruptions
- Kyocera offers one of the largest selections of cermets for grooving in the industry

Grades

TC40 - First choice for carbon and alloy steels

TC60 - Recommended for ID grooving and tool steel

GROOVING WITH COATED CARBIDES

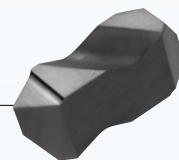

Advantages

- Offers better edge strength for high feeds and interruptions
- Coating improves tool life and surface finish
- Better suited for low speed applications or applications in heat resistant alloys and stainless steels

Grades

PR1215 - First choice for general purpose grooving. Apply in steel alloys, HRSA, stainless steels, and cast iron

PR930 - Good for general purpose steels and stainless steels at lower cutting speeds

PR660 - First choice for tougher applications and interrupted grooving

KW10 (Uncoated) - First choice for non-ferrous materials

GROOVING WITH CERAMICS

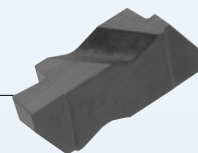

Advantages

- Ideal for grooving cast irons and hardened steels
- Excellent wear resistance
- No coolant needed

Grades

A65 - Higher tool life and reduced cycle times for continuous grooving of cast iron and hardened steels

Save Time & Money Grooving with Kyocera Cermets!

1144 Carbon Steel	
<p>Spool</p> <ul style="list-style-type: none"> • Vc=885 sfm • d=0.035" • fz=0.004 ipr • Wet • KCGP2031R TC40 	 <p>3 times longer tool life</p>
TC40	4200pcs / edge
Competitor A	1400pcs / Edge
<p>TC60 tripled the tool life of the competitor's coated carbide.</p> <p>(User Evaluation)</p>	

8620 Alloy Steel	
<p>Shaft Housing</p> <p>Kyocera Conditions</p> <ul style="list-style-type: none"> • Vc=750 sfm • d=0.040" • fz=0.003 ipr • Wet • KCGP3062L TC60 <p>Competitor Conditions</p> <ul style="list-style-type: none"> • Vc=550 sfm • d=0.040" • fz=0.003 ipr • Wet 	 <p>More than double tool life</p>
TC60	120pcs / edge
Competitor B	55pcs / Edge
<p>TC60 cut cycle time by 30% and doubled the tool life of the competitor's coated carbide.</p> <p>(User Evaluation)</p>	

GROOVING INSERTS

NEW

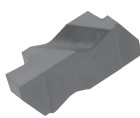
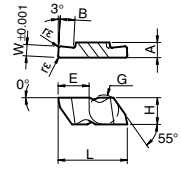
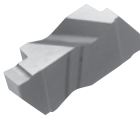
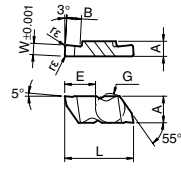
Insert	Part Number	Dimensions								Cermet		MEGA COAT CVD	Carbide			Ceramic
		±0.001								TC40	TC60	PR1215	PR660	PR930	KW10	A65
		W	B	R	A	L	H	E								
 	KCG 2062%	0.062	0.110	0.008	0.150	0.350	0.219	0.270								●
	2125%	0.125														●
	KCG 3062%	0.062	0.094													●
	3094%	0.094														●
	3125%	0.125	0.150	0.008	0.195	0.634	0.344	0.405								●
	3156%	0.156														
 	KCGP 2031%	0.031							●	●	●	●	●	●	●	
	2041%	0.041	0.050	0.003	0.150	0.350	0.219	0.270	●	●	●		●	●		
	2047%	0.047							●	●	●	●	●	●	●	
	KCGP 2058%	0.058	0.110	0.008	0.150	0.350	0.219	0.270	●		●		●	●	●	
	2062%	0.062							●	●	●	●	●	●	●	
	KCGP 2094%	0.094	0.110	0.008	0.150	0.350	0.219	0.270	●		●	●	●	●	●	
	2125%	0.125							●		●	●	●	●	●	
	KCGP 3031%	0.031	0.050						●		●		●	●		
	3047%	0.047	0.075	0.008	0.195	0.634	0.344	0.405	●	●	●	●	●	●	●	
	3062%	0.062							●	●	●	●	●	●	●	
	3072%	0.072	0.094						●		●		●	●		
	KCGP 3078%	0.078	0.094	0.008	0.195	0.634	0.344	0.405	●	●	●	●	●	●		
	3088%	0.088							●	●	●		●	●		
	KCGP 3094%	0.094	0.150	0.008	0.195	0.634	0.344	0.405	●	●	●	●	●	●	●	
	3097%	0.097							●				●	●		
	3105%	0.105							●		●		●	●		
	KCGP 3110%	0.110							●		●		●	●		
	3122%	0.122	0.150	0.008	0.195	0.634	0.344	0.405	●				●	●		
	3125%	0.125							●	●	●	●	●	●	●	
	KCGP 3142%	0.142							●				●	●		
	3156%	0.156	0.150	0.008	0.195	0.634	0.344	0.405	●	●	●	●	●	●		
	3178%	0.178							●				●	●		
	KCGP 3185%	0.185	0.150	0.008	0.195	0.634	0.344	0.405	●				●	●		
	3189%	0.189							●	●	●	●	●	●	●	
	KCGP 4125%	0.125	0.150	0.008					●		●		●	●		
	4189%	0.189	0.250	0.018	0.255	0.764	0.453	0.636	●		●		●	●		
	4213%	0.213							●				●	●		
	KCGP 4219%	0.219	0.250	0.018	0.255	0.764	0.453	0.636	●				●	●		
4250%	0.250							●		●		●	●			

Applicable Toolholders

Insert	External Holder ☉ P8	Internal Holder ☉ P10	Face Grooving Holder ☉ P9
KC_2...	KKC%...-2...	A...-KKC%...-2	-
KC_3...	KKC%...-3...	A...-KKC%...-3	-
KC_4...	KKC%...-4...	A...-KKC%...-4	-
KCF_3...	-	-	KKCE%...

● : U.S. Stock ● : Right-Hand Only ● : Left-Hand Only

FACE GROOVING

INSERTS

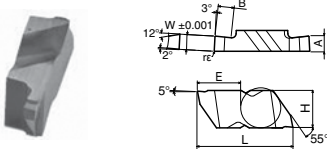
Insert	Part Number	Dimensions								Cermets		MEGA COAT CVD	Carbide			Ceramic
		W	B	R	A	L	H	E	TC40	TC60	PR1215	PR660	PR930	KW10	A65	
	KCFP 3125%	±0.001 0.125		0.008									●			
	3156%	0.156	0.150	0.008	0.195	0.634	0.344	0.405					●			
	3189%	0.188		0.023									●			

See P5 for Applicable Toolholders

See P9 for Groove Limits

DEEP GROOVING

INSERTS

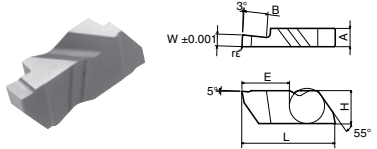
Insert	Part Number	Dimensions								Cermets		MEGA COAT CVD	Carbide			Ceramic
		W	B	R	A	L	H	E	TC40	TC60	PR1215	PR660	PR930	KW10	A65	
	KCGDP 3062%	±0.001 0.062	0.125	0.008	0.195	0.634	0.344	0.405	●		●		Ⓡ			
	3094%*	0.094	0.250	0.008	0.195	0.716	0.344	0.505	●		●		●			
	3125%*	0.125	0.250	0.008	0.195	0.716	0.344	0.505	Ⓡ		●		●			
	3189%*	0.189	0.250	0.023	0.195	0.716	0.344	0.505	●				●			

See P5 for Applicable Toolholders

* These inserts have one cutting edge

FULL RADIUS GROOVING

INSERTS

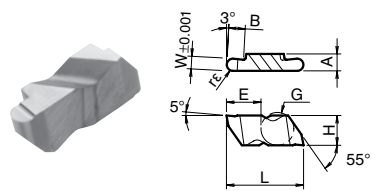
Insert	Part Number	Dimensions								Cermets		MEGA COAT CVD	Carbide			Ceramic
		W	B	R	A	L	H	E	TC40	TC60	PR1215	PR660	PR930	KW10	A65	
	KCRP 2031%	±0.001 0.062	0.094	0.031						Ⓡ	●	Ⓡ	Ⓡ			
	2039%	0.078	0.110	0.039									●			
	2047%	0.094	0.150	0.047							●					
	2062%	0.125	0.150	0.062						Ⓡ	●					
	KCRP 3031%	0.062	0.094	0.031						●	Ⓡ	●	●	●	Ⓛ	
	3047%	0.094	0.150	0.047	0.195	0.634	0.344	0.405	●		●	●	●			
	3062%	0.125	0.150	0.062					●		●	●	●			
	KCRP 3078%	0.156	0.150	0.078					●				●			
	3094%	0.188	0.150	0.094	0.195	0.634	0.344	0.405	●		●		●			
	KCRP 4125%	0.250	0.250	0.125	0.255	0.764	0.453	0.636	●		●	Ⓡ	●			

See P5 for Applicable Toolholders

● : U.S. Stock Ⓡ : Right-Hand Only Ⓛ : Left-Hand Only

THREADING INSERTS

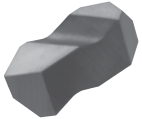
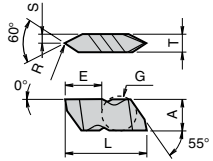
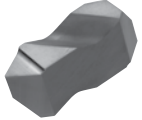
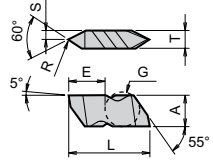
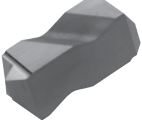
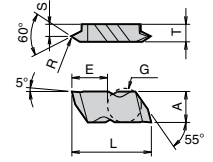
Insert	Part Number	Pitch TPI	Dimensions						Cermet		MEGA COAT CVD	Carbide			Ceramic
			A	T	R	E	S	L	TC40	TC60	PR1215	PR660	PR930	KW10	A65
 	KCT 2%L	External 8-36 Internal 7-20	0.219	0.150	0.004	0.266	0.075	0.350		●	●	●			
	KCT 3%L	External 6-20 Internal 5-12	0.344	0.195	0.007	0.400	0.098	0.634		●	●	●			
 	KCTP 2%L	External 8-36 Internal 7-20	0.219	0.150	0.004	0.266	0.075	0.350		●	●	●			
	KCTP 3%L	External 6-20 Internal 5-12	0.344	0.195	0.007	0.400	0.098	0.634		●	●	●			
 	KCTK 2%L	External 14-44 Internal 12-24	0.219	0.150	0.003	0.268	0.110	0.350		●	●	●			
	KCTK 3%L	External 10-44 Internal 9-24	0.344	0.195	0.003	0.402	0.141	0.634		●	●	●			

See  P5 for Applicable Toolholders

Cera-Notch Conversion Charts

Notch / Lock Style Inserts Conversion

Notch Style Grooving Inserts								
Inserts Style	Kyocera	Horizon	Tool-Flo	Kennametal	RTW	Valentine	Sandvik	Mitsubishi
Face Grooving	KCFP	HF	FLF	NF	-	-	TLF*	EF
ID or OD Grooving	KCG / KCGP	HG	FLG	NG	PG	VLG	TLG*	EG
With Chipbreaker	KCGP-MY	HG-K	FLG CB	NG-K	PG-K	-	-	EG-K
Deep Grooving	KCGDP	HGD	FLGD	NGD	PGD	-	-	EGD
Positive Grooving	KCGP	HGP	FLGP	NGP	-	VLGP	TLGP*	EGP
Full Nose Radius	KCRP	HR	FLR	NR	PR	VLR	TLR*	EGR
Positive Full Nose Radius	KCRP	HRP	FLRP	NRP	PRP	VLRP	TLRP*	-
Notch Style Threading Inserts								
Inserts Style	Kyocera	Horizon	Tool-Flo	Kennametal	RTW	Valentine	Sandvik	Mitsubishi
Face Grooving	KCT	HT	FLT	NT	PT	VLT	TLT*	ET
ID or OD Grooving	KCTK	HTK	FLTK	NTK	PTK	VLTK	TLTK*	-
With Chipbreaker	KCTP	HTP	FLTP	NTP	PTP	VLTP	TLTP*	-

* Sandvik uses a different clamp system. Requires Kyocera or any other standard clamp from competitor

EXTERNAL GROOVING

TOOL HOLDERS

KKC
KC INSERT

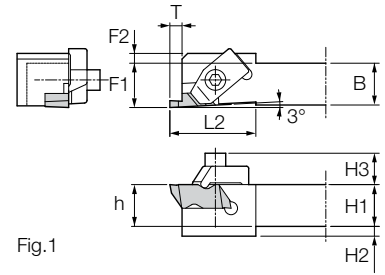
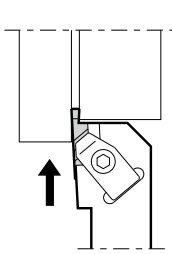

Fig.1

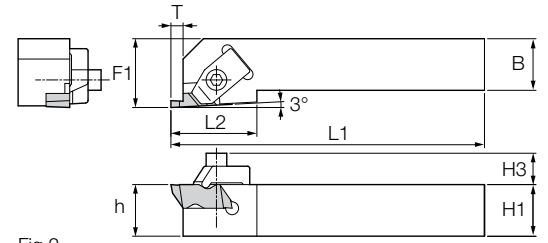

Fig.2

Part Number	Stock		Unit	Dimensions										Fig.	Spare Parts		
	R	L		H1=h	H2	H3	B	L1	L2	F1	F2	T	Clamp		Clamp Screw	Wrench	
KKC% 1212M-2-150F	●		mm	12	-	9.2	12	150	19.05	12.25	-	3.5	1	CKC-2 %	SKC-2	(7/64 hex)	
KKC% 6-2X	●	●	inch	0.375	-	0.362	0.375	2.500	0.750	0.562	-	0.138	2	CKC-2 %	SKC-2	(7/64 hex)	
6-2CF	●	●		0.375	0.125	0.362	0.375	5.000	0.750	0.385	0.125	0.138	1				
8-2X	●	●		0.500	-	0.362	0.500	3.500	0.750	0.750	-	0.138	2				
8-2DF	●	●		0.500	-	0.362	0.500	6.000	0.750	0.510	-	0.138	1				
10-2DF	●	●		0.625	-	0.362	0.625	6.000	0.750	0.635	-	0.138	1				
12-2B	●	●		0.750	-	0.362	0.750	4.500	0.750	1.000	-	0.138	2				
12-2C	●			0.750	-	0.362	0.750	5.000	0.750	1.000	-	0.138	2				
16-2C	●	●		1.000	-	0.362	1.000	5.000	0.750	1.250	-	0.138	2				
16-2D	●	●		1.000	-	0.362	1.000	6.000	0.750	1.250	-	0.138	2				
KKC% 12-3B	●	●		inch	0.750	-	0.465	0.750	4.500	1.250	1.000	-	0.210				2
12-3C	●	●	0.750		-	0.465	0.750	5.000	1.250	1.000	-	0.210	2				
16-3C	●	●	1.000		-	0.465	1.000	5.000	1.250	1.250	-	0.210	2				
16-3D	●	●	1.000		-	0.465	1.000	6.000	1.250	1.250	-	0.210	2				
20-3D	●	●	1.250		-	0.465	1.250	6.000	1.250	1.500	-	0.210	2				
16-4D	●	●	1.000		-	0.465	1.000	6.000	1.380	1.250	-	0.294	2				
20-4D	●	●	1.250		-	0.465	1.250	6.000	1.380	1.500	-	0.294	2				

Right-hand holders require right-hand inserts and clamps
 Left-hand holders require left-hand inserts and clamps

Items marked in () are not included with toolholder

Applicable Inserts

Toolholder	Insert
KKC...2	KC_2...
KKC...3	KC_3...
KKC...4	KC_4...

● : U.S. Stock

FACE GROOVING TOOLHOLDERS

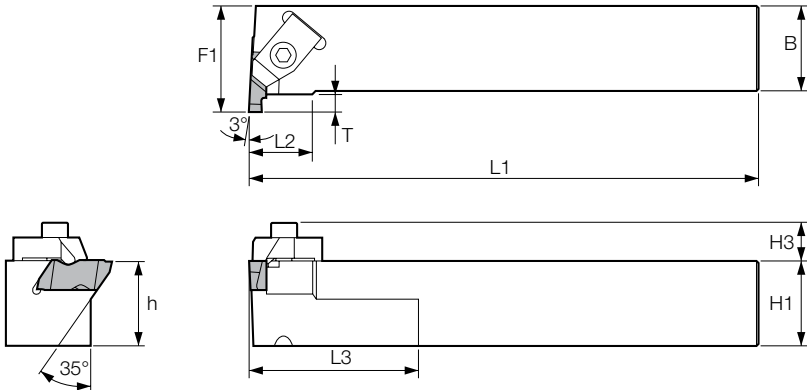

Part Number	Stock		Dimensions (inch)								Spare Parts		
	R	L	H1=h	H3	B	L1	L2	F1	L3	T	Clamp	Clamp Screw	Wrench
KKCE%L	●	●	0.750	0.465	0.750	4.500	0.750	1.125	2.000	0.210	CKC-3R/L	SKC-3	LW-156
	●	●	1.000	0.465	1.000	6.000	0.750	1.250	2.000	0.210			
	●	●	1.250	0.465	1.250	6.000	0.750	1.500	2.000	0.210			

Right-hand holders require left-hand inserts and clamps
 Left-hand holders require right-hand inserts and clamps

Applicable Inserts

Toolholder	Insert
KKCE...3	KCF_3...

Face Grooving Limits

Insert	MAX Groove Depth	MIN Groove Diameter
KCFP3...	0.060	0.940
	0.094	1.200
	0.125	1.420
	0.150	1.630

INTERNAL GROOVING TOOL HOLDERS

A-KKC
KC INSERT

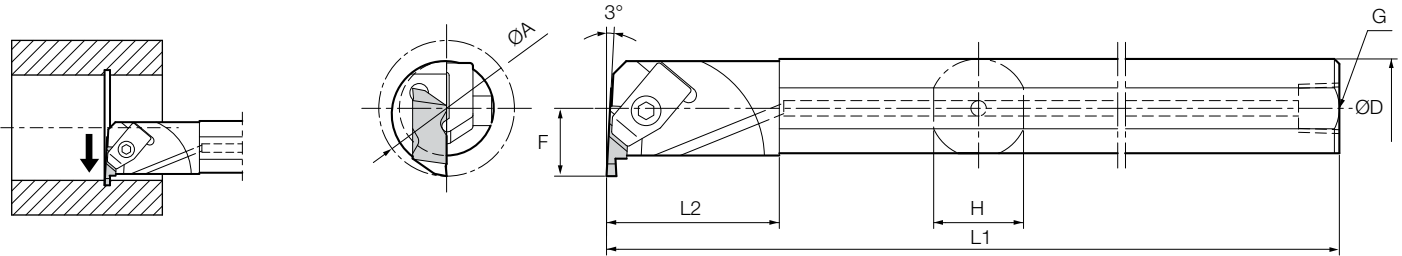

Part Number	Stock		Unit	Dimensions (inch)					Spare Parts		
	R	L		ØA*	ØD	L1	F	G	Clamp	Clamp Screw	Wrench
A10M-KKCR-2	●		inch	1.000	0.625	6.000	0.500	1/8-27NPT	CKC-2L	SKC-2	(7/64 hex)
A10S-KKCR-2	●			1.000	0.625	10.000	0.500				
A12R-KKCR-2	●			1.125	0.750	8.000	0.562				
A12S-KKCR-2	●			1.125	0.750	10.000	0.562				
A16T-KKC ^{3/4} -2	●	●		1.375	1.000	12.000	0.688	1/4-18NPT	CKC-2 ^{3/4}	SKC-3	(LW-156)
A16X-KKCR-3	●			1.375	1.000	9.000	0.688				
A16T-KKC ^{3/4} -3	●	●		1.375	1.000	12.000	0.688	1/4-18NPT	CKC-3 ^{3/4}	SKC-3	(LW-156)
A20U-KKC ^{3/4} -3	●	●		1.750	1.250	14.000	0.875				
A24U-KKC ^{3/4} -3	●	●		2.000	1.500	14.000	1.000				
A28U-KKCR-3	●			2.250	1.750	14.000	1.125				
A32V-KKC ^{3/4} -3	●	●		2.500	2.000	16.000	1.250				
A28U-KKC ^{3/4} -4	●	●		2.500	1.750	14.000	1.250				
A32V-KKC ^{3/4} -4	●	●		2.750	2.000	16.000	1.375				

Right-hand holders require left-hand inserts and clamps
Left-hand holders require right-hand inserts and clamps

Items marked in () are not included with toolholder

*Minimum bore varies with groove depth. See chart on [P11](#)

Applicable Inserts

Toolholder	Insert
KKC...2	KC_2...
KKC...3	KC_3...
KKC...4	KC_4...

● : U.S. Stock

Technical Information

Maximum Internal Groove Depth & Corresponding Minimum Bore Diameter

Insert	MAX Groove Depth	MIN Bore Diameter
KCGP 2031 ~ 2047	0.050	0.730
KCGP 2058 ~ 2125	0.110	2.500
	0.102	1.750
	0.098	1.500
	0.080	1.000
	0.055	0.730
KCGP 3047 ~ 3088	0.094	1.750
	0.090	1.625
	0.075	1.375
KCGP 3094 ~ 3189	0.150	2.375
	0.145	2.125
	0.138	1.875
	0.125	1.625
	0.110	1.375
KCGP 4125	0.150	2.750
KCGP 4189 ~ 4250	0.250	5.750
	0.245	5.000
	0.240	4.500
	0.218	3.250
	0.200	2.500

Cera-Notch Cutting Conditions

Workpiece Material	Cermet Feeds (ipr)	Carbide Feeds (ipr)	Insert Grade (sfm)						
			TC40	TC60	PR660	PR930	PR1215	KW10	A65
Stainless Steel	0.002~0.005	0.002~0.010	-	200~600	100~550	100~550	300~600	-	-
Carbon Steel	0.002~0.005	0.002~0.010	300~900	250~900	200~550	250~650	300~800	-	-
Alloy Steel	0.002~0.005	0.002~0.010	250~800	250~800	100~500	150~550	300~750	-	-
Tool Steel	0.002~0.005	0.002~0.010	200~650	200~650	-	100~550	300~600	-	-
Hardened Steel (>45Rc)	-	-	-	-	-	-	-	-	250~500*
Gray Cast Iron	0.003~0.006	0.002~0.012	200~700	-	-	-	300~700	-	500~1000
Ductile Iron	0.003~0.006	0.002~0.012	-	150~600	-	-	300~600	-	500~1000
Aluminum	0.002~0.008	0.002~0.012	150~1600	-	-	-	-	500~1600	-

Speeds & Feeds listed are for external grooving. Reduce parameters by 10% for internal grooving.

*Feeds = 0.003~0.008ipr



KYOCERA Precision Tools

102 Industrial Park Road
Hendersonville, NC 28792
Customer Service | 800.823.7284 - Option 1
Technical Support | 800.823.7284 - Option 2



W | Official Website | www.kyoceraprecisiontools.com
W | Distributor Website | <http://mykpti.kyocera.com>
E | cuttingtools@kyocera.com

©KYOCERA Precision Tools
10/14, 5K Printed in U.S.A.