



# Control Panel Technical Guide

How to reduce damage to components  
through effective thermal management



[schneider-electric.com](https://schneider-electric.com)

Life Is On

**Schneider**  
Electric







Many of our customers, including design and engineering departments, panel builders, integrators or even OEMs, ask us to help them optimise the performance of their electrical installations, while complying with environmental constraints and avoiding thermal problems.

Schneider Electric, as a leading international specialist in energy-efficiency management, has drawn up this expert's operating guide for these customers (and any others).

Through this overall fully practical and comprehensive document, Schneider Electric wants to share all its experience in thermal management of electric enclosures with its customers.

# Contents

	Introduction	4
	Thermal audit	7
	Introduction	8
	Internal analyses	10
	External analyses	11
	Schneider Electric offer	13
	Thermal optimisation solutions	15
	Introduction	16
	"Passive" solutions	17
	"Active" solutions	26
	ProClima software	56
	Practical summary	59
	Good reflexes for thermal management of enclosures	60
	Key figures for thermal management of enclosures	61
	Choosing the best thermal management solution	63
	Selection guide	64
	Thermal solutions & atmosphere	70
	Technical appendix	73
	Heat exchanges	74
	Operation constraints	79

# Introduction

## Malfunction of electrical installations

### Reasons

In the vast majority of cases, when electric installations and devices housed in control enclosures shut down or malfunction, the problem is thermal: excessively high or low temperature of electrical and, especially, electronic equipment.



Uncontrolled external climatic conditions



Internal heat balance not calculated



Pollution and difficult or harsh environmental conditions



High likelihood of a breakdown or malfunction of the installation

### Consequences

Even the slightest shut-down or malfunction of the electrical installation can have major – even catastrophic – financial repercussions for a company, regardless of its business sector.

Here are some examples of business sectors in which 1 hour of down time can be very expensive:

**50 000 €** Metalworking (foundry)

**40 000 €** Glassworks

**10 000 €** Motor industry

**6 000 €** Agri-business industry

**35 600 000 €** Microprocessor industry

**2 940 000 €** Banking transaction services

**90 000 €** Airline ticket-booking services

**47 000 €** Mobile telephone operators

**350 €** SMEs



# Thermal optimisation objectives

## > Avoiding

down-time and malfunctions caused by overheating of electrical and electronic devices

## > Reducing

- costs associated with the manufacturing processes
- maintenance cycles and costs for the installation

## > Extending

the service life of the internal components

## > Guaranteeing

continuity of service

# Introduction

## Conditions for an installation with no breakdown risk

Choose the right IP

(according to the environment)



Choose

the right thermal solution and correct installation



Knowledge

of losses of power in the installation (in W)



**Reliable installation  
and suitable protection**



# Thermal audit

# Introduction



It is essential to calculate a **complete, reliable heat balance** before considering any management solutions.

A heat balance consists of:

- To make the balance of the power dissipated by the installation
- To measure the temperature and the humidity inside and outside the enclosure
- To evaluate the quality of the ambient air

Based on these measurements, the **ProClima software** will help you **identify the solutions that best suit your control enclosure in which it is installed.**

## > Internal analyses > External analyses

- Analysis of thermal conditions inside the enclosure
- Calculation of the power dissipated by the component

- Analysis of weather conditions
- Analysis of air quality

## Zoom on

### Your heat balance with ProClima software

How does it work? Nothing could be easier!

Simply enter the collected thermal data in the software. ProClima will then suggest the solutions that best suit the features of your installation. And only these solutions!



## > Foreword

First of all, **it is essential to identify the most delicate devices or functions: the ones that should be given protection priority.**

Delicate devices can be the cause of shut-downs or malfunctions of the installation.

### Important to know

- Critical temperature for each device
- Critical humidity level for each device

	Recommended operating temperature	Maximum temperature with the risk of malfunction granted
Variable speed drives	35°C	50°C
Programmable logic controller	35°C	40 - 45°C
Contactors	45°C	50°C
Circuit breakers	45°C	50°C
Fuses	50°C	50°C
Power supply	35°C	40°C
Printed Circuit Board (PCBs)	30°C	40°C
Electric batteries (accumulators)	20 - 25°C	30°C
Telecommunications equipment	40 - 50°C	55°C
Battery of capacitors	50°C	55°C

- Electronic equipment is the most delicate
- Ideal internal temp. = Critical temp. of the most delicate device
- High critical temp. of the variable speed drives: 50°

### Case study: Cranes with electro-magnetic lifting systems for handling



#### Example 1:

The concentration of variable speed drives can push the inner temperature up to 70°C or higher (with no thermal solution installed).



#### Example 2:

Batteries are highly sensitive to temperature changes. They should not exceed 25-30°C.

Batteries: 10 years lifetime

### Expert's tip

- The thermal management solution must be sized according to the critical temperature of the most delicate element of the enclosure. This temperature should never be exceeded.
- The mean working temperature recommended for the inside of the enclosure is 35°C. This is the reference temperature for the control equipment integrated in the thermal solution.

# Internal analyses

1

## > Measuring the air temperature inside the enclosure

The measurement of air temperature inside the enclosure, must be taken over a complete period (e.g.: one production cycle, 24 hours, 1 week, etc.).

### This data will be used:

- To complete the overall thermal analysis
- To avoid exceeding the critical temperature of each device
- To calculate the loss of power (W) of each device

### Expert's tip

The temperature measurement inside the enclosure should be taken in three separate areas (T1, T2 and T3). Avoid the ventilated hot-air outlet.

The hot-air ventilation flows affect the temperature in the various areas. Also, each case must be studied separately and in detail.

Mean temp. of the enclosure =  $(T1 + T2 + T3) / 3$ .

2

## > Measuring losses of power (W)

Before performing the thermal calculation, it is important to have detailed information of **the dissipation value of each component**. Generally speaking, this value is not easy to find.

### Expert's tip

Use the **ProClima software** to find out the dissipation value of the components in your enclosure. **ProClima** offers the loss values for all the most common devices on the market.

# External analyses

## > Analysis of weather conditions

1

### > Measuring the air temperature (°C)

To ensure reliable calculations, the external temperature measurement should be taken over **a complete period** (e.g.: one production cycle, 24 hours, 1 week, etc.).

#### What to measure

- Max. mean temperature
- Min. mean temperature

2

### > Measuring the humidity level (%)

This consists of determining whether the environment is:

- **Dry:** Humidity level < 60%
  - **Humid:** Humidity level between 60% and 90%
  - **Very humid:** Humidity level > 90%
- Temperature variations detected in the environment will let you know whether or not there is condensation.



- Heat balance calculated using reliable values.
- Specific calculations in the ProClima software.
- Optimisation of the thermal management solution: minimises under- or over-sizing errors.



# External analyses

## > Analysis of air quality

It is essential to **measure and analyse air quality in the installation area of the control enclosure.**

**A prior inspection of the installation site** is generally enough to identify the constraints to which the electrical and electronic devices will be exposed.

### Difficult environments examples

- Sites with presence of oils, solvents and aggressive substances
- Saline, corrosive or sugary environments
- Dusty atmospheres: cemeteries, flour mills, ceramic and wood processing plants, rubber factories, etc.
- Nuclear, chemical, petrochemical sites, etc.
- Bottling plants (high humidity levels)
- Metalworking sites
- Textile plants (fibres tend to block the air intakes)



#### Example 1:

Plant manufacturing car parts.  
The presence of oil in the environment reduces the service life of the components.



#### Example 2:

Fan not working due to the presence of sugar in the plant (beer production).



#### Example 3:

Busbar installed in a water treatment site.  
The humid, corrosive atmosphere has damaged the copper.

- Find out whether the temperature and the quality of the external air can help cool the enclosure ("Passive" solution).
- Knowing the installation site well helps optimise the protection level of the thermal solution (e.g.: filter thickness) and the protection level of the enclosure (e.g.: IP degree according to EN 60529).



# Schneider Electric Offer

With ClimaSys DT, Schneider Electric provide you simple and precise tools to evaluate thermal conditions of your installation, greenfield or brownfield.

## > Introducing ClimaSys Diagnostic Tools (DT)

With ClimaSys DT dataloggers and EffiClima software, you can know with maximum accuracy the temperature evolution, humidity levels, and dew points inside and outside your control panels.

This data can then be analyzed with ProClima thermal software to determine the optimal thermal solution for each of your control panel installations.



Measuring tool

Tracking in EffiClima



Temperature, humidity, dew point report

## > Choose the right thermal solution

### ClimaSys DT advantages

You can:







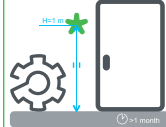

- Size properly
- Optimize performance
- Avoid local thermal issues

# Schneider Electric Offer

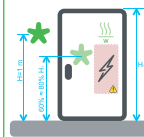
## > Table of choices

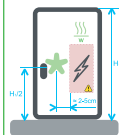
### How to use ClimaSys DT

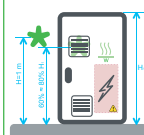
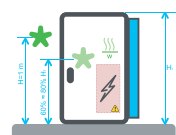
Connect to PC, check in Efficlima, analyze in ProClima.

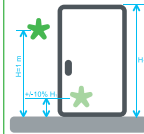
Installation	Need		Selection of the dataloggers			
	What do you want to do?		Variables to measure	How many dataloggers needed?	Model	Recommended installation
Greenfield		New project Determine enclosure sizing needs and the correct thermal solution	<ul style="list-style-type: none"> <li>■ T° outside</li> <li>■ RH outside</li> </ul>	1	DTH	
Brownfield		Measure the power dissipation (w) Enclosure without thermal solution installed	<ul style="list-style-type: none"> <li>■ T° outside</li> <li>■ T° inside</li> </ul>	2	DTT or DT	
		Electronics health test Verify that there are no hot/cold spots	<ul style="list-style-type: none"> <li>■ T° inside</li> </ul>	1	DTT or DT mini	
		Thermal solution test Measure the efficiency of the existing thermal solution in a certain period of time	<ul style="list-style-type: none"> <li>■ T° outside</li> <li>■ T° inside</li> </ul>	2	DTT or DT mini	  <i>Check ventilation</i> <i>Check cooling</i>
		Humidity/condensation test Measure the risk of high humidity or condensation inside the enclosure	<ul style="list-style-type: none"> <li>■ T° inside</li> <li>■ T° outside</li> <li>■ RH inside and outside</li> </ul>	2	DTH	



# Thermal optimisation solutions

# Introduction



**There are two main families of thermal management solutions:**

- **So-called "Passive" solutions:** these are adaptations of the electrical switchboard to the constraints of temperature and humidity. They concern the sizing of the enclosure and the arrangement of the components. Economic solutions, they must be defined during the design phase.
- **So-called "Active" solutions:** these are additional components (fan, exchanger, cooling unit, resistance heater) for the management of the temperature and the humidity inside the enclosure. Solutions that can be costly, they must be chosen and sized with precision.

## > "Passive" solutions

- Choice of material
- Size of the enclosure
- Location of the enclosure
- Wall insulation
- Component distribution
- Exteriorization of heat sources
- Cable layout
- Natural airing or convection
- Natural dissipation

## > "Active" solutions

- Thermal control device
- Forced ventilation
- Temperature management with air-conditioners
- Temperature management with air-water exchangers
- Temperature management with air-air exchangers
- Resistance heaters
- Ultra-thin resistance heaters
- Air circulating

### Expert's tip

Maximise the use of "Passive" solutions before choosing an "Active" solution.

# "Passive" solutions

1

## > Choice of enclosure material

The choice of material for the enclosure (steel, stainless steel or polyester) is essential for ensuring the natural dissipation of calories released by the electrical or electronic devices.

### Zoom on...

#### the phenomenon of natural dissipation of calories

Natural dissipation of calories depends on the **total heat-transmission coefficient: K**. This coefficient represents the capacity of the enclosure to exchange heat with the outside. This exchange takes place by convection and possibly by radiation. It is expressed in  $W / m^2K$ .

- **Mean values of K**

- Steel: 5 à 5.5
- Stainless steel: 3.7
- Polyester: 3.5

# "Passive" solutions

## 2

### > Surdimensionnement de l'enveloppe

As with the material, **the size of the enclosure (useful occupied surface area in m<sup>2</sup>) affects the inner temperature level.**

If the external temperature is favourable (< 35°C), increase the size of the enclosure makes it possible to reduce the internal operating temperature and to slow down a possible rise in temperature.

**The energy savings can be substantial:**

- Up to **50%** for steel enclosures
- Up to **65%** for polyester enclosures

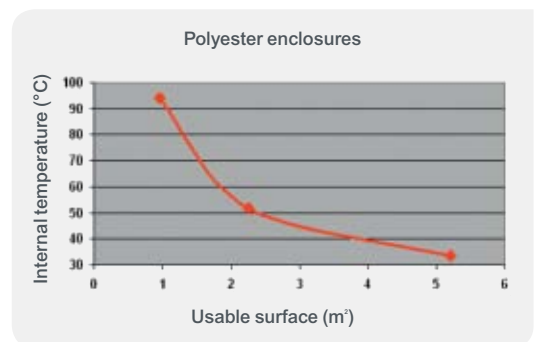
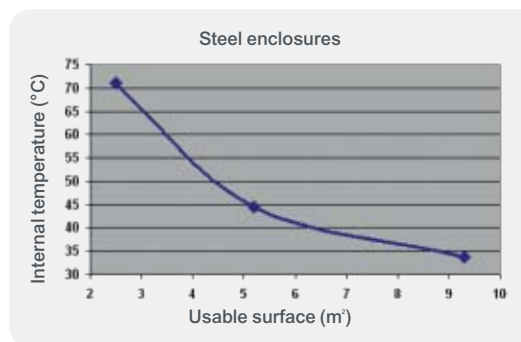

- Avoids problems of condensation on the most delicate devices (electronic)
- Avoids corrosion on metal parts

### Example

CASE N°1	Enclosure specifications:	Calculation:	
CASE N°1	Dimensions: 1800 x 600 x 500 mm	$T_i = T_e + Pd / (S_e \times K)$	<b>T<sub>i</sub> = 53°C</b>
	Matériau: steel	$S = 3.55 \text{ m}^2$	
	Position: back to the wall	$T_i = 27 + 500 / (3.55 \times 5.5)$	
	Loss of power (Pd): 500 W	$= 27 + (500/19.525)$	
	External temp (T <sub>e</sub> ): 27°C	$= 27 + 25.6 = 53$	
CASE N°2	Enclosure specifications:	Calculation:	
CASE N°2	Dimensions: 2000 x 800 x 600 mm	$T_i = T_e + Pd / (S_e \times K)$	<b>T<sub>i</sub> = 45°C</b>
	Matériau: steel	$S = 5.07 \text{ m}^2$	
	Position: back to the wall	$T_i = 27 + 500 / (5.07 \times 5.5)$	
	Loss of power (Pd): 500 W	$= 27 + (500/27.885)$	
	External temp (T <sub>e</sub> ): 27°C	$= 27 + 17.9 = 45$	

## 3

### > Location of the enclosure

**The position of the installed enclosure is a factor which should not be neglected,** since the walls of the enclosure affect the heat transfer process.

For example, if the enclosure is installed in an equipment room where the **temperature is favourable (< 35°C), all the walls should be left accessible such as to facilitate the dissipation of calories.**



# 4

## > Insulation of the enclosure

When the external temperature is high, the calorie intake through the surfaces of the enclosure increases the internal temperature.

If a high external temperature (> 40°C) is permanently recorded and a source of radiation is detected, the solution will be to thermally insulate the walls of the enclosure.

### Expert's tip

In the latter case, extraction must be carried out in an "Active" manner, using an air-conditioner or an air-water exchanger.

The energy saving (measured by the cooling capacity gain) is around 25% for metal enclosures and 12% for polyester enclosures.

#### Without insulation

Cooling power required: 2200 W

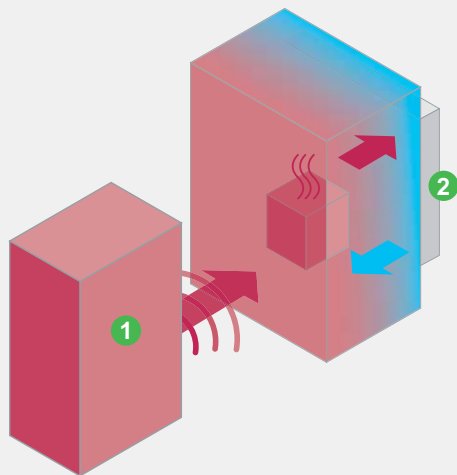

#### With insulation

Cooling power required: 1630 W

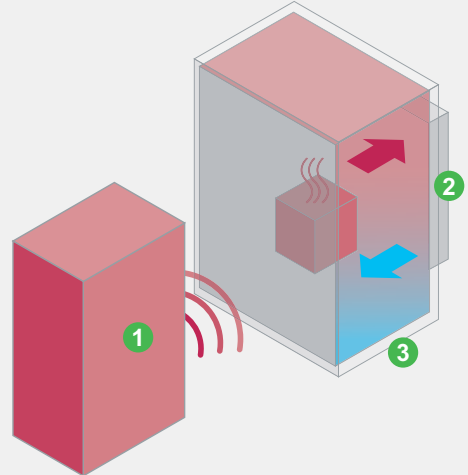

- ① Irradiated heat source (molten metal, etc.)
- ② Air-conditioner
- ③ Insulation

### Expert's tip

Insulation can also be used as a "Passive" solution when the external temperature is very low and permanently exceeds the critical temperature of the installed devices.

E.g.: installations in cold storage rooms, outdoors (-20°C), etc.

# "Passive" solutions

## 5

### > Repartition of components

The distribution of the components in several enclosure is a very efficient solution.

in addition of the **energy saving**, it has others important advantages:

- Reduction in the risk of hot spots
- Reduction of the average temperature
- Optimisation of the active solution

Otherwise, the concentration of components in an enclosure can be detrimental to low-power components that are constrained by higher power components.

#### Expert's tip

- A thermal partition can be used to separate loads and optimise the solution.
- It is preferable to separate the control enclosures and the power enclosures.

#### Example

**Case No. 1:**  
More powerful thermal solution  
(example: air-conditioner)

**Case No. 2:**  
Weaker and efficient thermal solution  
(example: ventilation)

- ① Power enclosures
- ② Control enclosure
- ③ Cooling unit
- ④ Ventilation

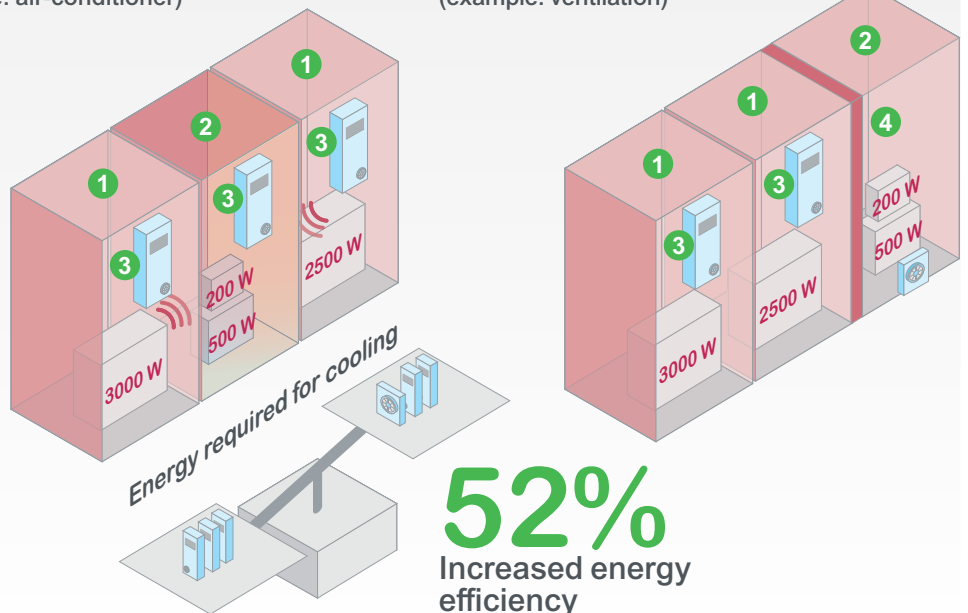

#### Expert's tip

The **highest loads** must be installed as **low down as possible**. In this way, the amount of air inside the enclosure can cool the dissipated heat and favour internal air convection.

## Rules to be observed For the layout of devices inside the enclosure

- Respect the air gap distances inside the enclosure.
- Create an air column covering the entire height of the enclosure (100 to 200 mm wide), between the air intake and outlet. This will avoid overheating and losses of thermal efficiency.

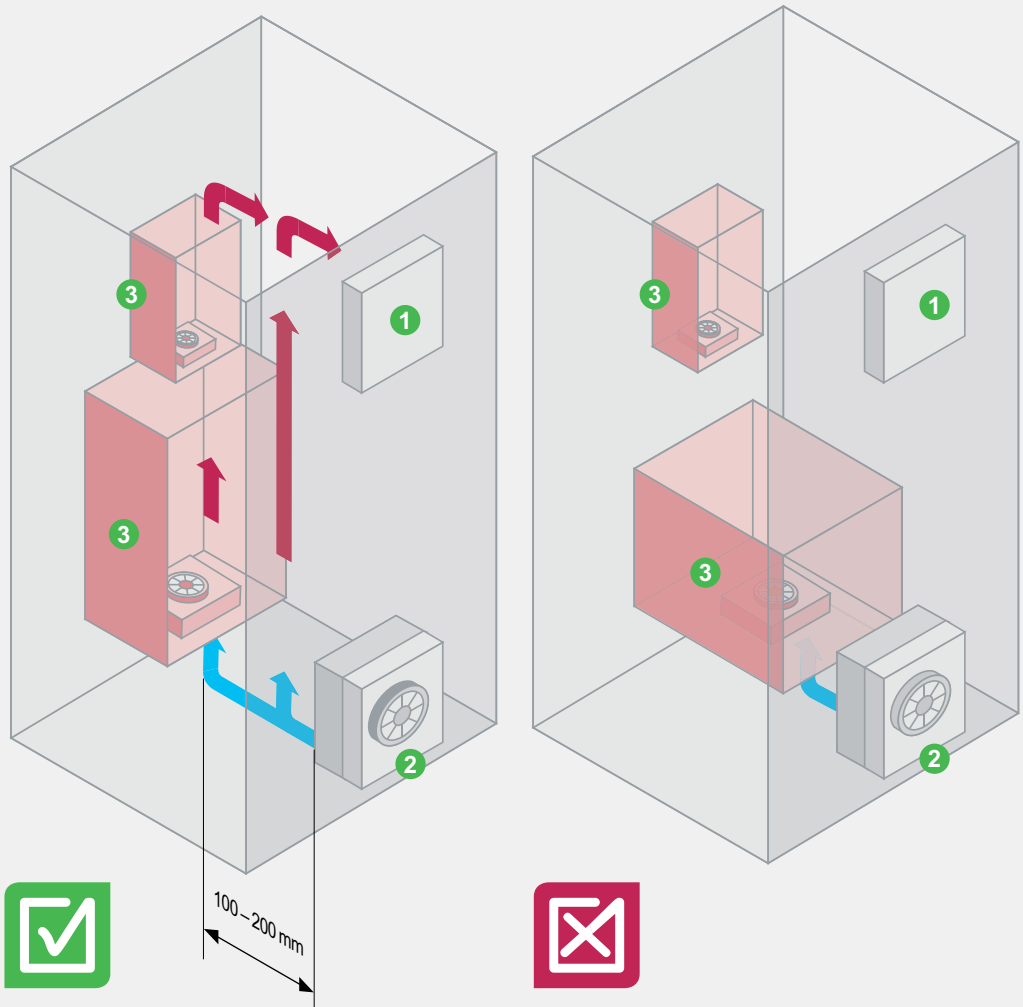

- ① Outlet grilles
- ② Fan
- ③ Drives

# "Passive" solutions

# 6

## > Moving heat source to the outside

Some electric components give off vast amounts of heat. This is the case, for example, with the **braking resistances of the variable speed drives** (around 500 W to 3.5 kW).

These **calories must be extracted** using cooling units ("Active" solutions), unless this type of equipment is installed outside of the enclosure.

# 17%

Increased energy efficiency

- Direct energy efficiency.
- Optimisation of the "Active" thermal solution.



# 7

## > Cable layout

The wiring of the devices can be a source of heating.

Also, there should be **good habits**:

- The cables **should not rest on the devices**
- The **ventilation grilles should not be obstructed**
- **Screw or snap-fit the locking elements**

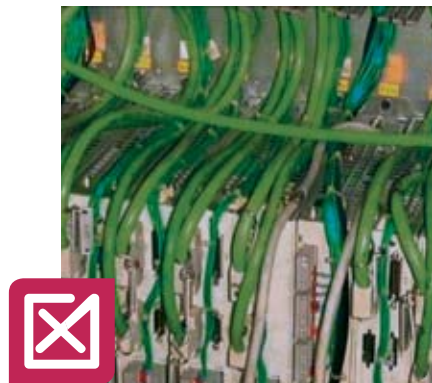
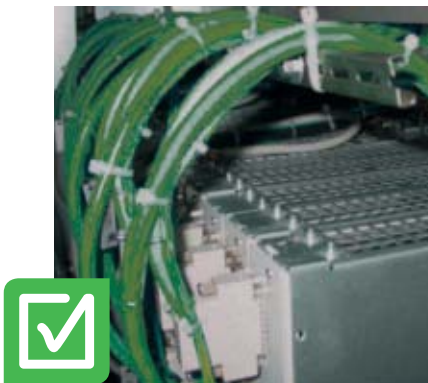

# 8

## > Air-flow management

Free space above and below for ventilation

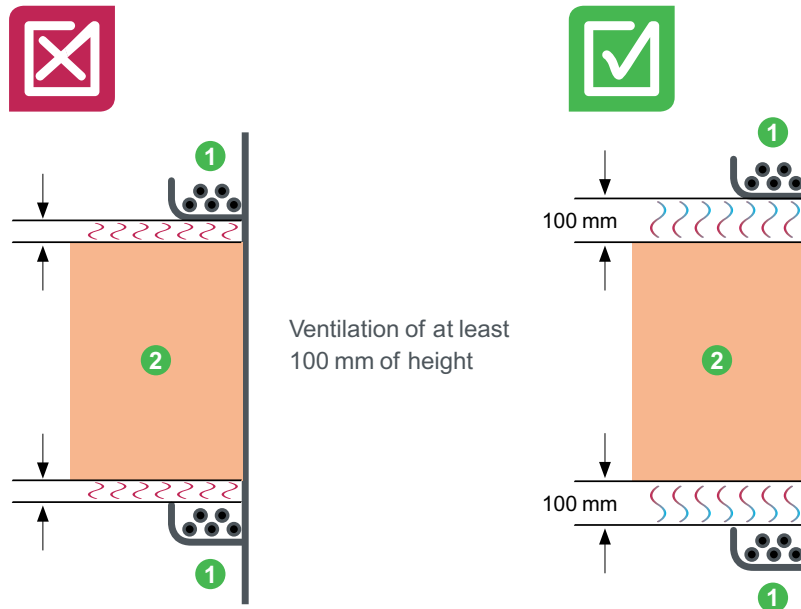

### Expert's tip

- Avoid blocking the air outlets of the electronic equipment.
- Always leave a ventilation space of at least 100 mm at the top and bottom (= extended service life for the devices).

# "Passive" solutions

## 9

### > Natural aeration

Passive convection solutions is made by:

- The aeration grids (side or roof) with or without filter,
- Roof elevators,
- Natural ventilation hood.

#### Exemple

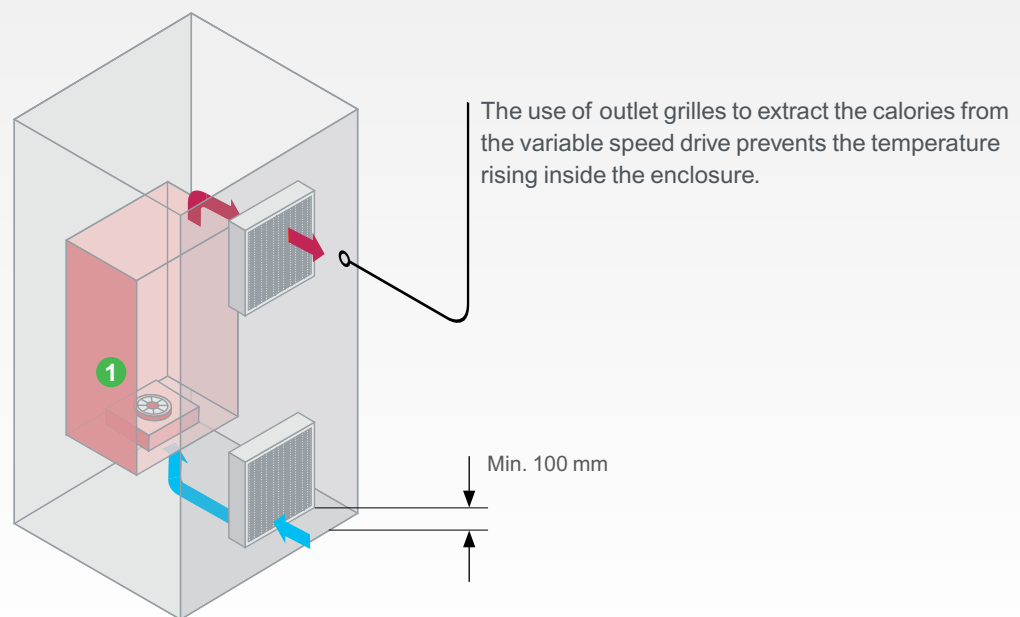

1 Drive



#### In which circumstances is the filter not required?

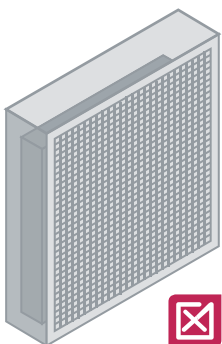

The natural dissipation flow rate is better with no filter.

However, this is only possible under certain conditions: (e.g.: clean rooms)



#### Expert's tip

- Select the filter type according to the environment in which the enclosure is installed (difficult, harsh, polluted, etc. or good air quality).
- Service the filter on a regular basis to avoid clogging and loss of flow.

# → Schneider Electric offer

**ClimaSys range of airing systems** includes plastic (standard application) and metal grid.(CEM application).

## Characteristics of plastic materials

- Material: ASA PC, Self-extinguishing by UL 94 V-0 with improved resistance (longer service life) to UV.
- Color: RAL 7035. RAL 7032 (replacement accessory). Other colours are available on demand (contact us).
- Delivered with G2 M1 synthetic standard filter.



RAL 7035



RAL 7032

**ClimaSys** top-mounted ventilation range is a natural airing device for coupling to the top of metal floor-standing enclosures. Ideal solution for combining with the ventilation slots.



- Fixing to the top by means of caged nuts and special screws.
- Material: steel.
- Finish: painted with epoxy-polyester resin, textured RAL7035 grey.
- Protection rating: IP54.



# "Active" solutions

- Thermal control
- Forced ventilation
- Climatisation
- Air-water exchangers
- Air-air exchangers
- Resistance heaters
- Air circulating



# 1

## > Thermal control

The use of thermal controllers such as **thermostats or hygrostats** helps stabilise the temperature and humidity conditions inside the enclosure.

It also helps optimise the power consumption required.

### Where should the thermostat be placed in the enclosure?

#### Example 1:

At the top (the hottest part of the enclosure)



Temperature inside the enclosure regulated by 2 fans controlled by 1 thermostat according to the temperature detected inside of the enclosure:

- fan 1 active if  $T_i \geq 45^\circ\text{C}$
- fan 2 active if  $T_i \geq 55^\circ\text{C}$

#### Example 2:

Next to the most delicate devices



Temperature inside the enclosure regulated by 1 heating resistor and 1 fan controlled by 1 thermostat from the information supplied by 2 temperature sensors: S1 located inside the enclosure, S2 located outside.

- Active fan if S1 provides  $T_i \geq 45^\circ\text{C}$
- Active resistance if S1 provides  $T_i \leq 10^\circ\text{C}$

With the sensor S2, it is possible to compare the temperature inside and outside the enclosure and, depending on the result, to control the fan, resistor, or activate an alarm (enclosure located outside).

# Up to 58%

Energy savings  
(compared with a solution without thermal control)

### Expert's tip

Two additional probes can be used to optimise the measurement.

# "Active" solutions

## → Schneider Electric offer

The **ClimaSys range of thermal controllers** is made up of mechanical and electronic thermostats and electronic hygrostats and hygrometers.



### Mécanic thermostats

- NO (blue button) with normally open contact to control the starting of a fan when the temperature exceeds the displayed maximum value.
- NC (red button) with normally closed contact to control the stopping of a resistance heater when the temperature exceeds the displayed value.
- Temperature control: 0°C...+60°C.
- Small dimensions.

### Electronic thermostat with LED screen

- Input voltages : 9-30 V, 110-127 V, 220-240 V.
- Operating temperature: -40°C...+80°C.
- Option of installing an external sensor, for remotely reading the temperature (operating temperature: -30 °C...+ 80 °C ).
- 2 separate output relays for the control of the ventilation and the heating (1 relay for the hygrostat).

### Electronic hygrotherm with LED screen

### Electronic hygrostat with LED screen

### Expert's tip

- Electronic thermostats and hygrostats are more accurate than mechanical models.
- Controller can be used to reduce the consumption of the thermal solution.
- Install the thermostats in the top of the enclosure: this is the hottest part.
- As for the hygrostats, the best location is the bottom of the enclosure: this is the most humid part.

# 2

## > Forced ventilation

When combined with a thermal control device, forced ventilation is one of the best solutions in terms of energy efficiency.

**The performance of the forced ventilation depends greatly on external temperature conditions and air cleanliness. Also, measurements and analyses must be performed before installation.**

### Expert's tips

- The ambient temperature must be strictly less than 5°C below the desired temperature inside the enclosure
- Measure the external temperature before validating the solution.
- The thermal controller is very useful for adapting the power of the "Active" solution to the required charge level. For example, you can use two fans and only activate one or two according to the temperature.

**If the enclosure is properly sized and the loads are properly distributed:**

- > Ventilation direction pointing inwards
- > If the enclosure heats up too much (Temp. > 60°C), use a centrifugal fan.

# X2

Service life of the fans

**Increased pressure thanks to the air pulse:**  
no dust enters through the openings.



## Schneider Electric offer

The **ClimaSys forced ventilation range** fulfils most cooling needs, with energy savings and high performance levels.

### Characteristics

- Flow rate without grille, with filter (230 V / 50 Hz): from 38 m³/h to 850 m³/h.
- Material: Injected thermoplastic (ASA PC). self-extinguishing according to UL 94 V-0.
- Ingress protection rating: IP54.
- Colour: RAL 7035 as standard, with the option of RAL 7032.

# "Active" solutions

## Side-mounted pulsing ventilation architecture with thermal control

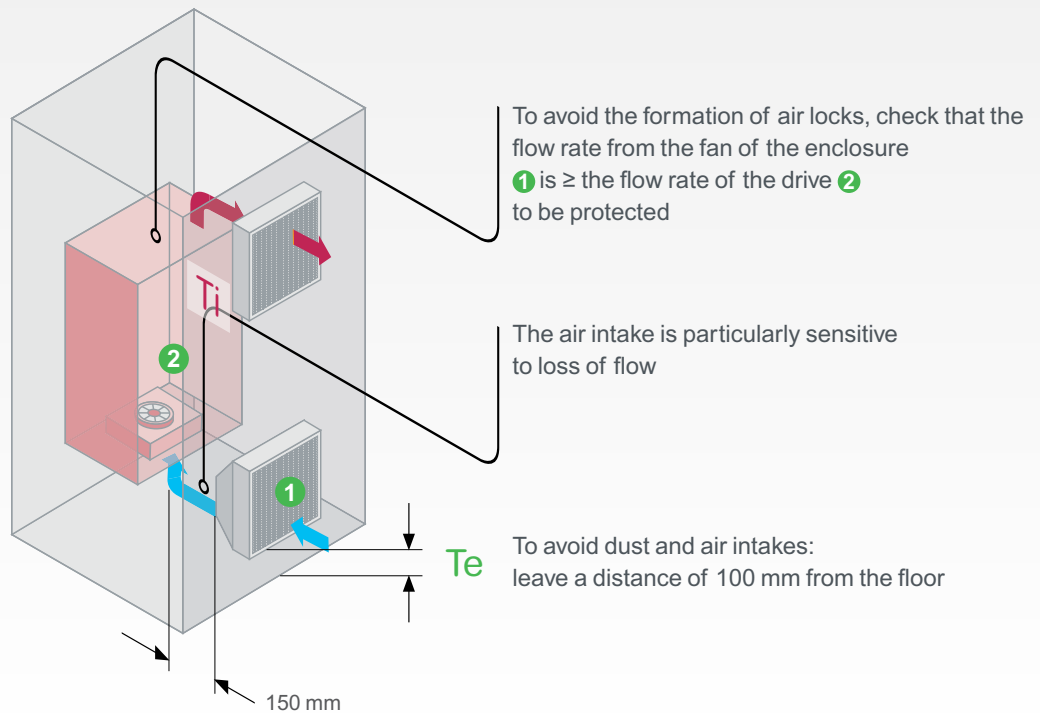

## Top-mounted extraction ventilation architecture with thermal control

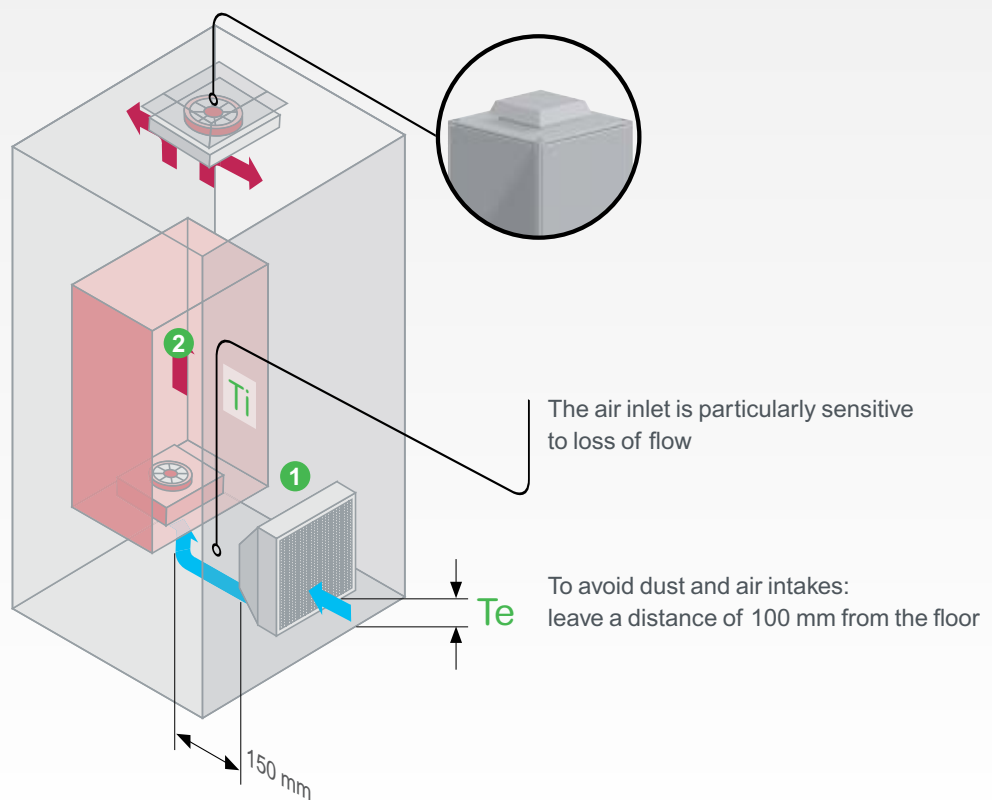

### Expert's tip

- If the enclosure heats up too much (Temp.  $\geq 60^{\circ}\text{C}$ ), use the top-mounted extraction ventilation, with high-speed centrifugal fan (from 500 m<sup>3</sup>/h).
- It is essential to use filter-clogging and thermal control elements.



- High cooling speed (extraction power).
- Energy efficiency (with an accurate electronic controller).

### ★ Roof fan or side fan?



Centrifuge



Axial

If the power dissipated by the components is high, the cooling with a centrifugal fan (roof-mounted) is more efficient than with an axial fan (side-mounted).

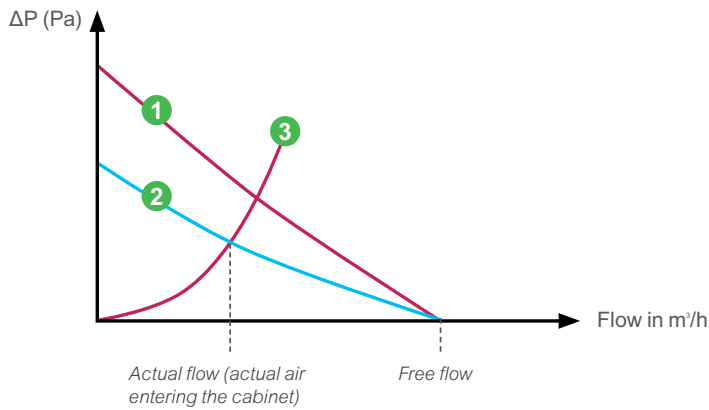

- ① Moteur centrifuge
- ② Moteur axial
- ③ Plastic parts + filter + power dissipated the components inside the enclosure

# "Active" solutions

## 3

### > Air-conditioners

Air-conditioners or cooling units are widely used for **cooling enclosures which contain devices that give off a lot of heat.**

They **dehumidify the total volume of the enclosure** by extracting condensation water.

#### Utilisation case of an air-conditioner

- When the external temperature is too high to ventilate (Temp. > 35°C).
- When the atmosphere is highly polluted, but it is possible to use a filter to protect the external part of the air-conditioner.

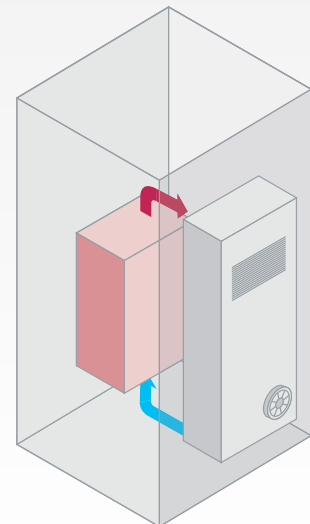
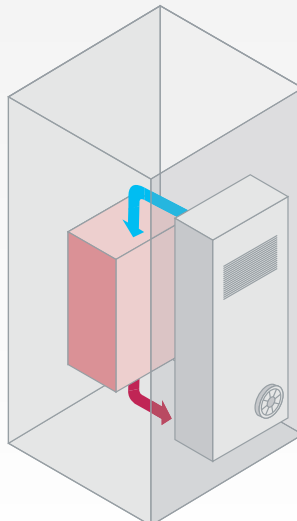

#### Pay attention to the air flow direction!

Cold air must be directed downwards (not direct), observing a distance of at least 200 mm between the cold air outlet and the air intake of the drive.

#### Expert's tip

- Use deflectors to avoid heat shocks. If the hot-air emitted by the air-conditioner is in direct contact with the air outlet of the drives, a heat shock may occur (condensation forming in the enclosure).
- Make sure the drives are correctly centred relative to the thermal solution.
- Have the filters replaced regularly by the maintenance team (e.g.: every four weeks for critical workshops).
- Avoid the typical mistake of blocking the air-conditioner air outlet. Consequences of the blockage: reduced performance and/or appearance of heat shocks.



### Drive-cooling architecture with side-mounted air-conditioner

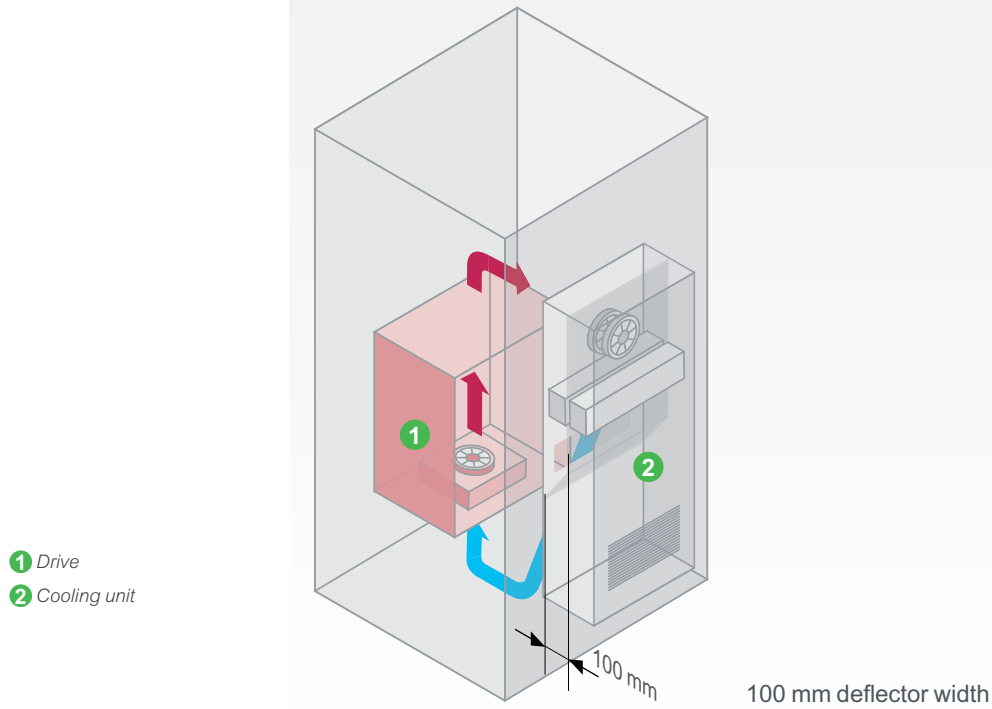

### ★ Installation at the rear of the enclosure

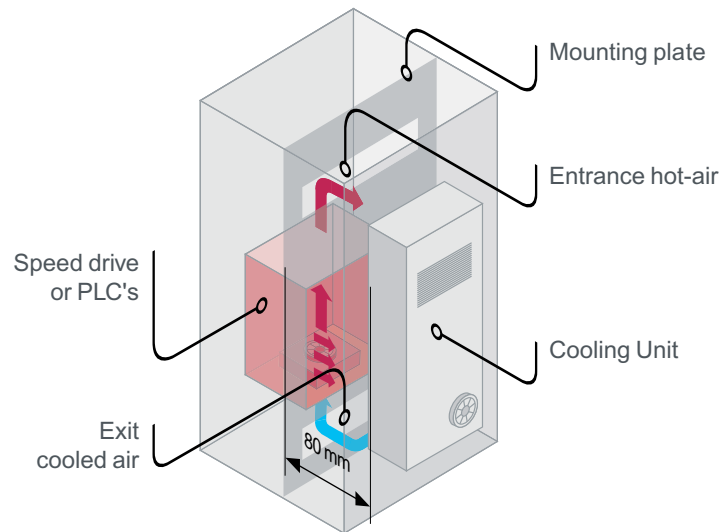

- Effective distribution of cold/hot-air.



# "Active" solutions

## ★ Installation on the door



### Drive cooling architecture with roof cooling unit

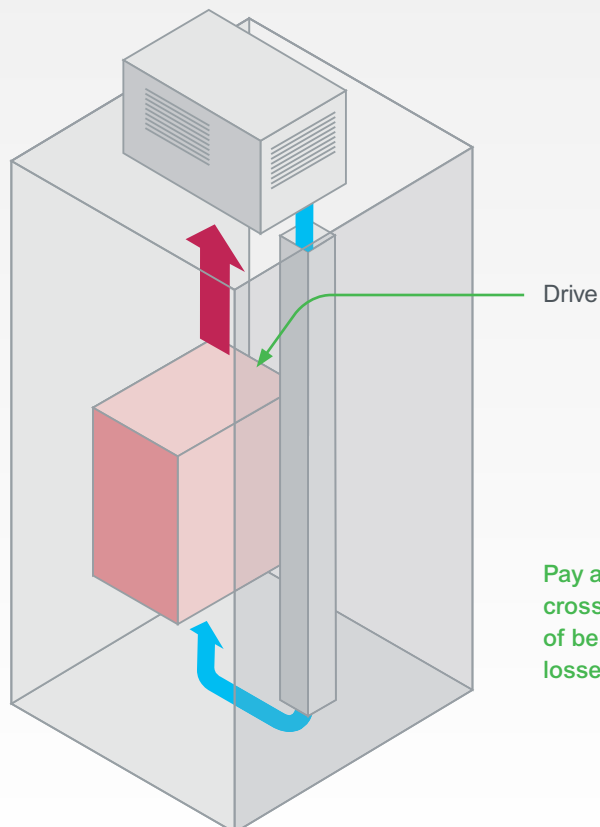

Pay attention the pipe cross-section and the number of bends in order to avoid flow losses at the drive inlet.

### Expert's tip

- Leave enough space to guarantee correct convection, from the roof to the bottom of the enclosure.
- Leave a minimum lateral depth of 150 mm, and avoid any obstacles (risk of loss of load and performance).

**★ Technical sheet**

**CLL 1050 50Hz**

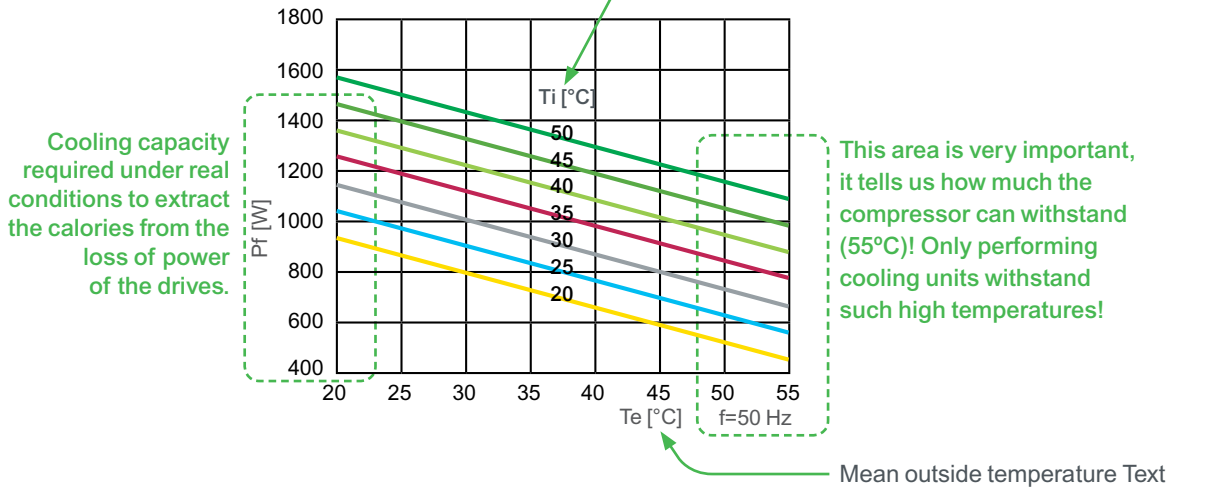

**Expert's tip**

Save time by using the ProClima software and selecting the cooling unit that is best suited to the demands of your installation.

# "Active" solutions



## Installation tips

1



- The hot-air (output) enters the second group.
- Loss of performance or shutdown if  $T_e > 55^\circ\text{C}$ .

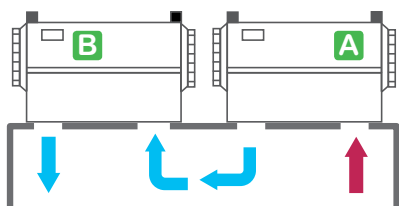

- The cold air of group A is aspirated by the inlet of group B.
- The thermostat of B stops the compressor and stops cooling.

2

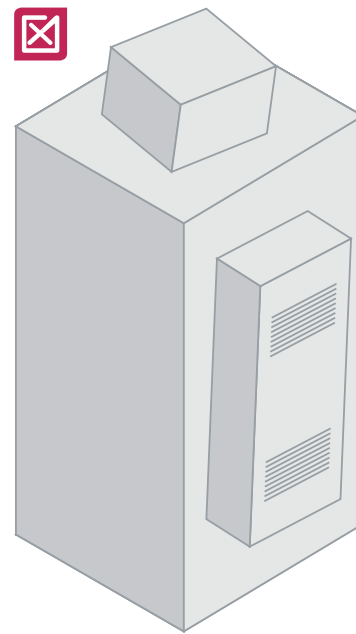
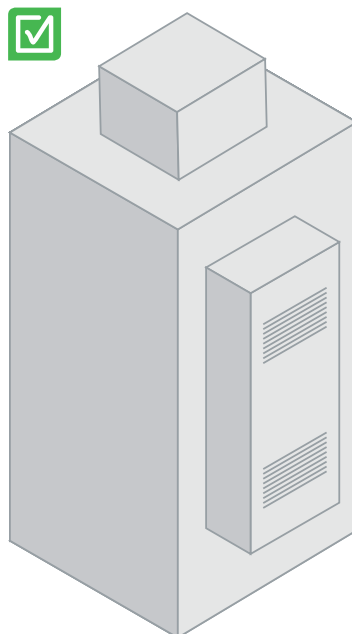

- Special care must be taken to make sure the groups are totally upright.
- A deviation of more than  $3^\circ$  may cause a malfunction.

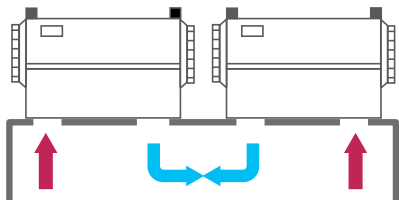

- The two air outputs "crash", and this reduced output impairs performance.

3

The cold air outputs from inside the enclosure should be free of obstacles.

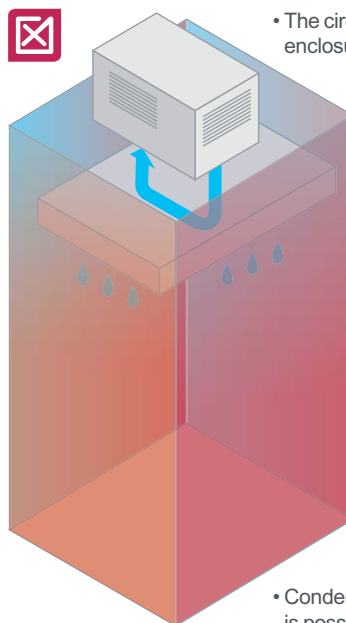

- The circuit closes and the enclosure does not cool.

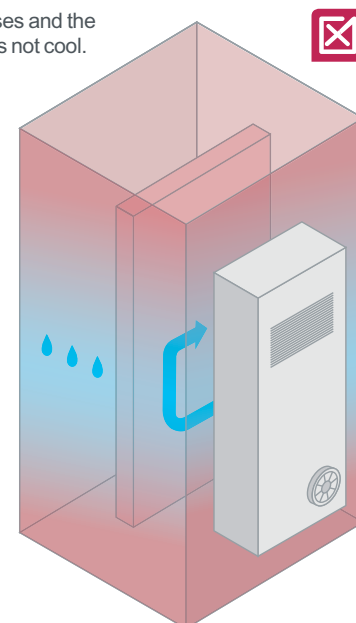

- Condensation is possible

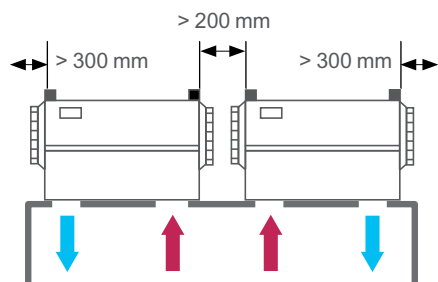

- Pay special attention to minimum clearances.

# 4

- Technical rooms.

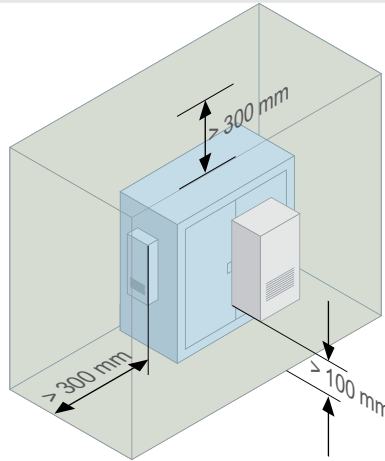

# 5

- In small spaces the renovation of the ambient air is indispensable.
- Otherwise, ambient temperatures 55°C could easily be reached and the group would shut down.

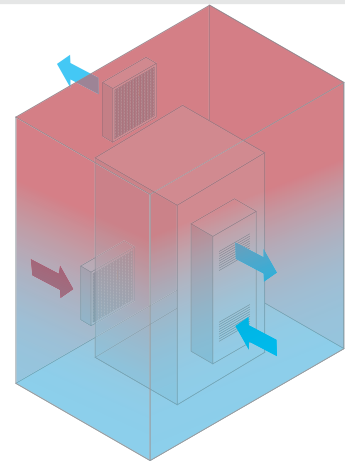
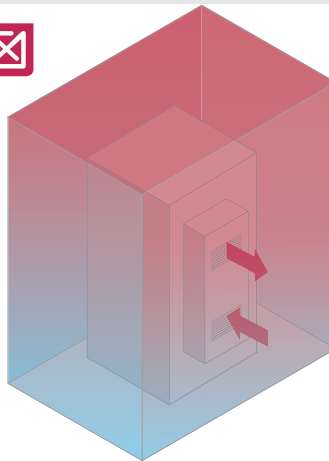

# 6

- The lack of sealing in the enclosure reduces performance and increases water condensation in the evaporator.
- Typical problem of the badly-closed door, badly sealed cables glands, high roofs, etc.

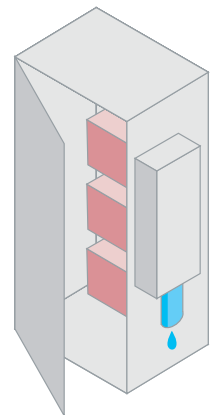

## Expert's tip

Save time by using the ProClima software and selecting the cooling unit best suited to the demands of your installation.

# "Active" solutions

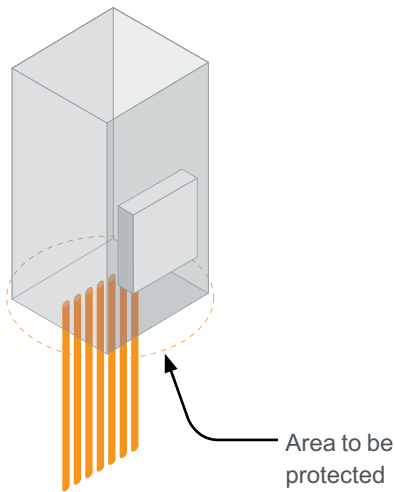

## Useful information!

### Check that the cable entries are perfectly sealed

**The most common mistake** with the enclosure + airconditioner solution is leaving the cable-entry open, and not providing a sealing system (foam, etc.).

### Side-mounted or top-mounted?

- Top-mounting should be considered when the site does not allow the installation of a side-mounted air-conditioner.
  - > Reduced accessibility (compared with a side-mounted solution)
  - > Importance of respecting internal air circulation in order to ensure correct convection
  - > Installation generally used for high-power enclosures (> 3 kW): it makes the device heavy.
- Side-mounting is more commonly used.
  - > Maximum accessibility (easier maintenance)
  - > The cold unit is near the devices that emit most heat (variable speed drives).

### Advantages of cooling unit with electronic control

- High adjustment precision (+/- 1°C).
- Since its contacts are built into the doors, the electronic controller waits 2-3 min before resuming operation. Result: the cooling fluids return to their original state.
- Indication of the internal temperature value.

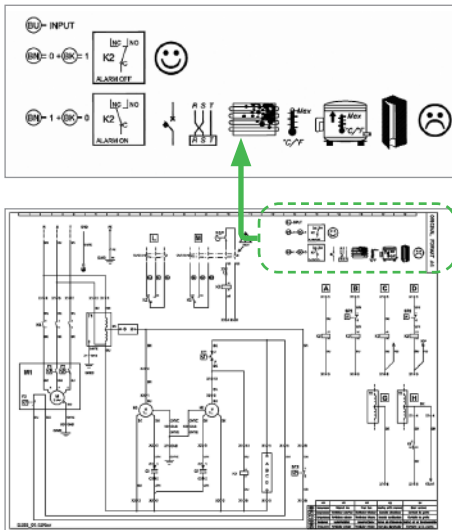

## Air-conditioner faults in the contact

All the ClimaSys cooling units are equipped with a fault signalling system.

This signal can indicate:

- A sudden disconnection
- An incorrect three-phase connection
- A clogged filter
- Excessively high compressor temp.
- Excessively low compressor temp.

## Filters

Types of filter:

- Polyurethane filter: for extremely dusty environments
- Stainless-steel filter: for oily environments
- Special filters are available for environments with a high concentration of textile fibres. Do not hesitate to consult us.

For extremely aggressive environments, the condensing battery (external) can be protected by a coating.

The filter replacement frequency depends on the level of pollution of the installation site. It is essential to be able to assess this level of pollution in order to select the correct filter quality and anticipate its replacement.

### Expert's tip

If the environment is pollutant-free, you can do without the filter. In this case, the cooling unit will gain performance (around 5% to 10% higher).

# "Active" solutions

## Useful information! (contd.)

### Evacuating condensation water

There are several ways to evacuate condensation water:

> **"Passive" solutions:**

- With a pipe, connected to the water outlet of the plant
- With a container, intended for recovering the water

> **"Active" solutions:**

- With an external dissipation system

**Warning! Permanent contact between the condensation water and the walls of the enclosure can speed up the corrosion phenomenon.**



- ClimaSys cooling units have an evaporation temperature between 8 and 12°C. This is generally enough to obtain a temperature of 35°C (in the enclosure). Furthermore, ClimaSys solutions do not generate much condensation water.
- ClimaSys roof units also include a built-in evaporation system. No additional energy required for evaporating the water.

### "Passive" solutions

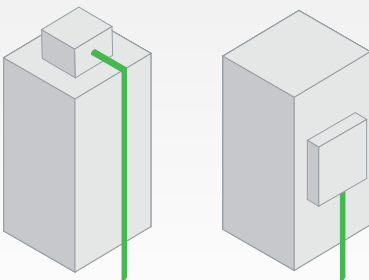

### "Active" solutions: Condensate evaporation kit

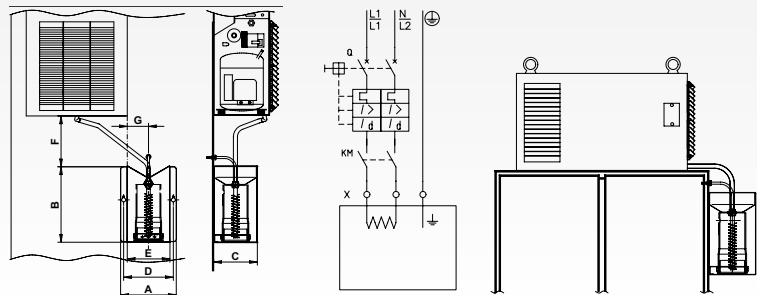

### Expert's tip

**Before installing an active water-evacuation solution:**

- Check the amount of water generated by the air conditioning.  
*NB: for a dry environment, this should be low or even very low.*
- Check whether it is possible to use an external water outlet.
- Check for proper water circulation: downwards (no curves on the initial level)
- Use a transparent pipe in order easily to identify any clogging or plugs in the pipe.



# → Schneider Electric Offer

**ClimaSys cooling units** offer complete solutions in all installation versions: side and roof.

## Characteristics

- Cold power L35-L35: de 300 W à 15150 W
- Withstands extreme temperature conditions (up to 55°C)
- Guaranteed protection rating: IP 54 and IP 55 (range SLIM)
- Built-in adjustable thermostat
- Automatic evaporation system (roof-mounting installation)
- Maximum security
- Easy maintenance (access to the condensers)
- Environmentally friendly: R134a (HFC) eco-friendly gas



# "Active" solutions

## 4

### > Air-water exchangers

Air-water exchangers are used mainly for **cooling or heating enclosures installed in difficult or harsh environments**: cemeteries, paint production chains, oily workshops, etc. **Places where filters clog very quickly.**

This **solution is completely sealed**: all side-mounting models are IP55 type protected internally and externally according EN 60529..

Top-mounting models are IP54. The air-water exchanger is capable of **extracting a large number of calories** from the enclosure (by fluid exchange).

These calories are then released outside the plant (chiller-type cooling unit).

This means that the water can come from other sources.



Ideal solution for highly-polluted environments and/or those with a high level of humidity (e.g.: water-treatment plants, bottling plants, wastewater plants, etc.).

- Calories dissipated to the outside.
- Water temperature can be checked at any time.

#### Example 1 :

Printing machines



Constraints: High evacuation of calories  
+ high seal

#### Example 2 :

Paint production chain



Constraints: Level of dust (filters blocking)  
+ humidity/condensation

#### Expert's tip

Save time by using the **ProClima software**, selecting the air-water exchanger that is best suited to the demands of your installation.

### Drive cooling architecture with a side-mounted air-water exchanger

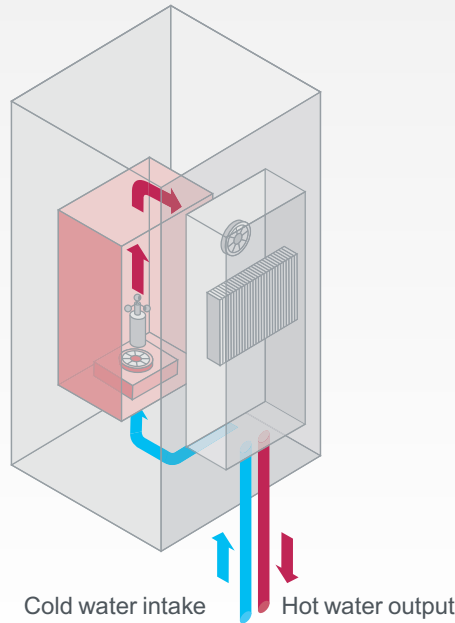

#### \* Parts

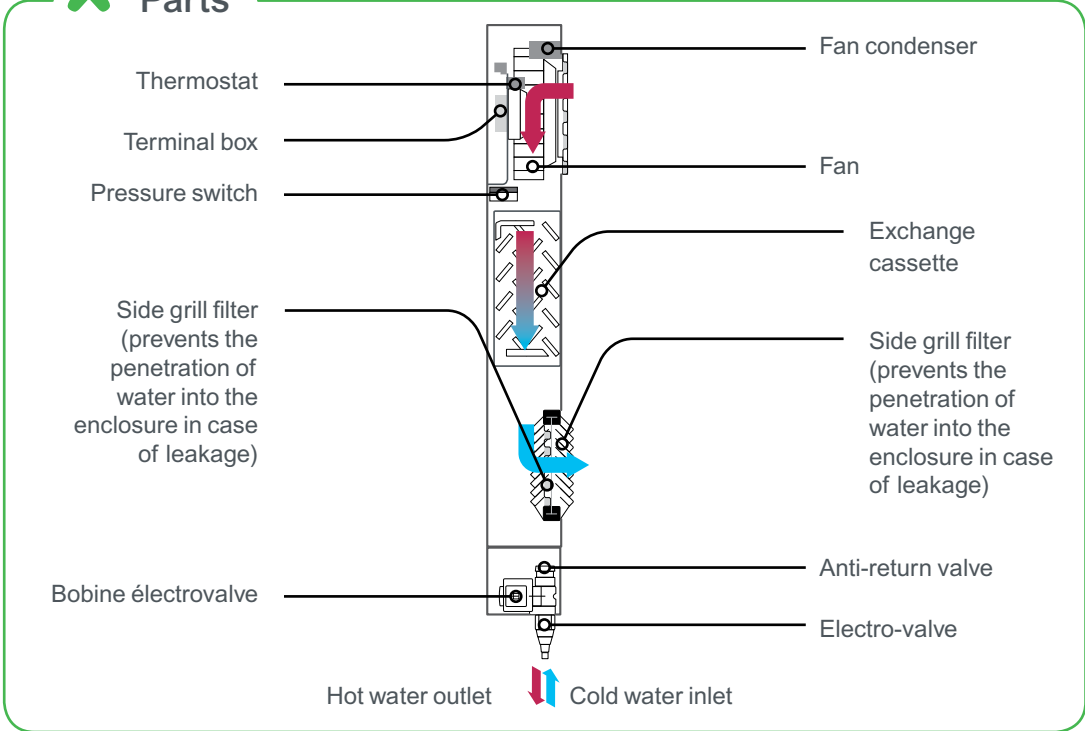

#### Expert's tip

Please consult our catalogues to find performance curves according to the water flow rate, water temperature and the desired working temperature inside the enclosure.

# "Active" solutions

## → Schneider Electric Offer

**ClimaSys air-water exchangers** are sealed solutions capable of extracting a large amount of calories from the enclosure.

### Characteristics

- Side installation or roof installation
- Easy maintenance (access to the batteries for easy cleaning)
- Internal temperature control (built-in thermostat)
- Guaranteed protection rating: IP55 (IP54 for roof mounting)
- Maximum security (anti-leak system)



# 5

## > Air-air exchangers

The use of air-air exchangers requires a **temperature difference between the inside of the enclosure and the outside of at least 10°C** ( $T_i > T_e$ ).



- Inner temperature ( $T_i$ ) always higher than the outer temperature ( $T_e$ ).
- Protection rating maintained: IP54.
- Much lower maintenance frequency than fans.
- Works without a filter: the inner and outer air circuits are kept separate by the exchanger.
- Ideal solution for:
  - > Equipment rooms (mean temp. of 25 °C)
  - > Already air-conditioned sites
  - > Agri-business industries (good temperature but corrosive environment).

### Expert's tip

Perform regular **preventive maintenance of the battery** of the exchanger.

# "Active" solutions

## Drive-cooling architecture with a side-mounted air-air exchanger

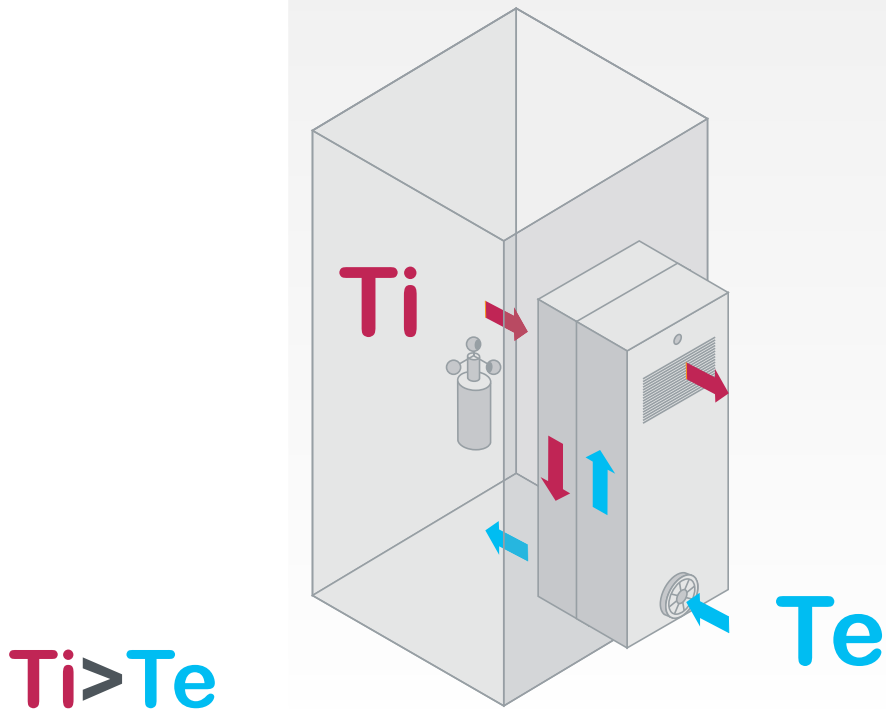

### \* Parts

- Exchange cassette
- Two Fans. For the inside circuit (permanent operation) and for the outside circuit (driven by the thermostat).
- They are of the **centrifugal** type, with good behaviour in case of pressure losses.
- Thermostat for controls the operation of the outside fan.



# → Schneider Electric Offer

**ClimaSys air-air exchangers** are sealed solutions, designed for **relatively cool environments** (around 25°C), and for installations with medium losses of power (1000 W per enclosure).

## Characteristics

- Side installation
- Power from 14 W/K à 80 W/K
- Easy cartridge maintenance and replacement (special configuration)
- Built-in thermostat
- No filter required (reduced maintenance and costs)
- Guaranteed protection rating: IP55



# "Active" solutions

## 6 > Resistance heaters

The resistance heaters are destined to the enclosures located in humid places, where temperature variations are important, or when the temperature is low (<5°C). These climatic conditions can create condensation.

- Avoids high levels of humidity.
- Controls the condensation phenomenon.
- Allows the electronic devices to be started up conveniently in cold or very cold atmospheres.

By **modifying internal temperature** of sealed enclosure (IP 54 or +):

- The temperature is maintained above the dew point, thus avoiding condensation,
- If the IP is high, the humidity is stable

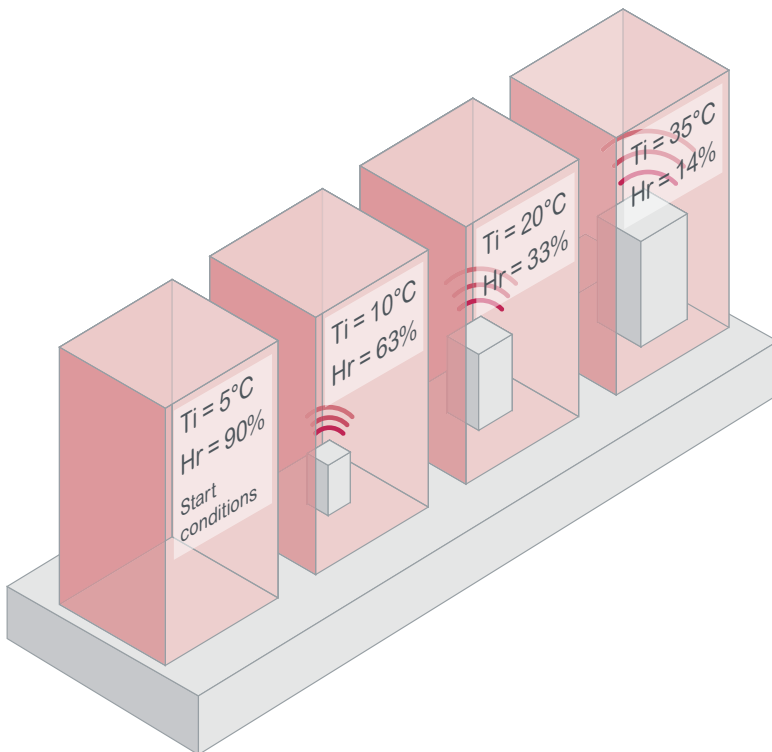

**Expert's tip**

- Check that the resistance heater is correctly installed using a **hygrostat** (checking the relative humidity: RH as a %) or a **thermostat** (checking the temperature in °C or °F)
- The enclosure must be sealed to prevent humid air from entering the hot areas of the enclosure.

### Where should the resistance heaters be installed?

The resistance heaters should **be installed at the very bottom of the enclosure. As low as possible.** Also consider the internal convection that the heat they produce will generate. This is why it is important to leave a **distance of at least 150 mm between the roof of the resistor and the first device.**

**NB:** For large enclosures, leave a free column of air. For example, leave the space between two coupled enclosures free.





# "Active" solutions



## Schneider Electric offer

**ClimaSys resistance heaters** are the best way to prevent the formation of condensation or humidity inside the enclosure or even to protect the installation against cold or very cold environments.

### Insulated or ventilated-insulated resistors

- Two extraction modes: by natural convection or with a fan
- Seven power levels from 10 W to 550 W
- Designed for a good natural convection and a very high thermal efficiency
- Housing: plastic UL 94 V-0
- Maximum security (PTC-type heater)
- Easy installation and connection (direct clipping on 35-mm DIN rail)
- CE marking and UL and VDE conformity



### Aluminium resistors

- Equipped with a PTC-type detector
- Eight power levels from 10 W to 400 W
- Improved convection
- Quick fixing (clipping on 35-mm DIN rail)
- Connection terminal board (heaters > 20 W)



### Ultra thin resistance heaters

- Installation: 5 mounting solutions
  - > On a Telequick mounting plate
  - > On plain or micro-perforated mounting plate
  - > On DIN rail
  - > On plain mounting plate with selfadhesive Velcro pads
  - > On wall with self-adhesive Velcro pads
- Material: silicon reinforced with fibreglass
- Small thickness : 1.6 mm
- Certifications : VDE, LR
- Low starting current
- The heat is distributed over the whole surface and does not exceed 70°C



# 7

## > Air circulating

The **air circulation inside the enclosure** is used to distribute uniformly the calories. Conséquences :

- **Lower the temperature.**
- **No localised hot spot.**
- **Distribute the cold air** released by the cooling units (air-conditioner, exchangers). This extraction solution should be considered for aggressive environments when the mixing flow rate is not sufficient.

### Expert's tip

- It is advisable to be able to direct the flow from the air circulating fans (e.g.: towards delicate devices, recurring hot spots, etc.).
- The greater the mixing flow, the quicker dissipation will take place.

# "Active" solutions

## Air circulating architecture for a single enclosure

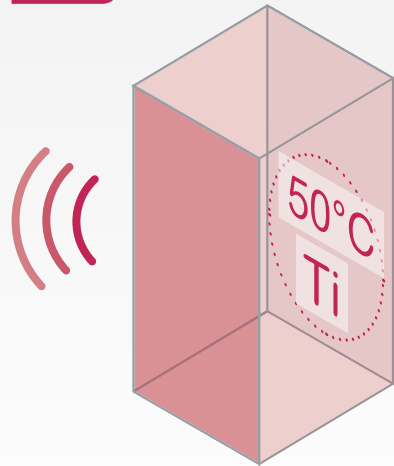

Without an air circulating solution, the temperature can reach 50°C or higher at the top of the enclosure.

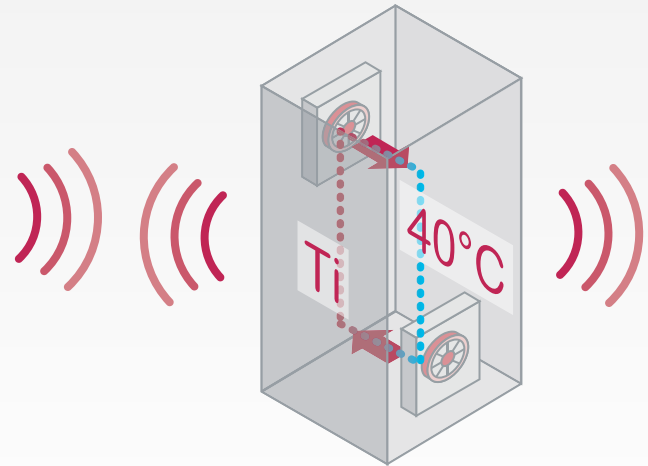

With an air circulating solution, the temperature is equalised throughout the enclosure. It is lower than the maximum value without convection.

### Air circulating architecture for coupled enclosures

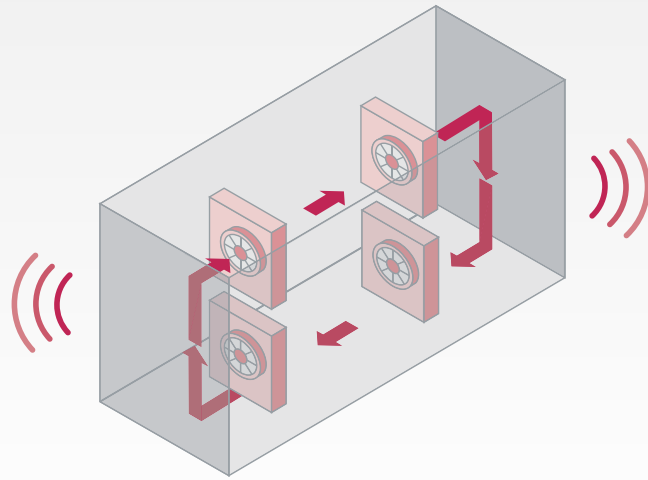

This consists of creating internal air circulation, with no turbulence.

### Architecture for an air-conditioner & air circulating combination

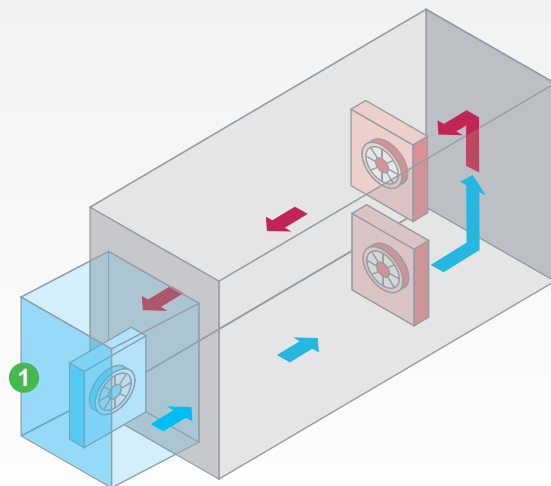

1 Air-conditioner

### Expert's tip

Leave an additional air-circulation space of at least 150-200 mm deep.

# "Active" solutions

## → Schneider Electric offer



### Characteristics

- User protection according to DIN 31001.
- Flow rate without grille: 170 m<sup>3</sup>/h (Free flow).
- Voltage: 115 ou 230 V.
- Power: 17 W.
- Weight: 0,82 kg.
- Audio level: 41 dB (A).
- Dimensions:
  - > Fan: 119 x 119 x 38 mm.
  - > Collar: length 140 mm, fixing centre-to-centre distance : 130 mm.
- Installation on ball-bearing.





# ProClima software

## The essential expert's tool

Your thermal study in **seven steps**

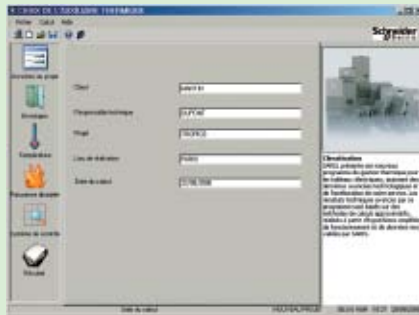

1 > Enter the project and customer details (optional)

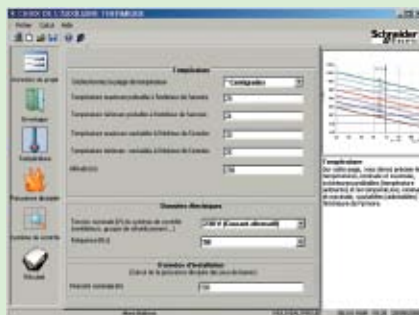

2 > Enter the internal and external temperature data



3 > Enter the electrical specifications of the installation (voltage, power, etc.)

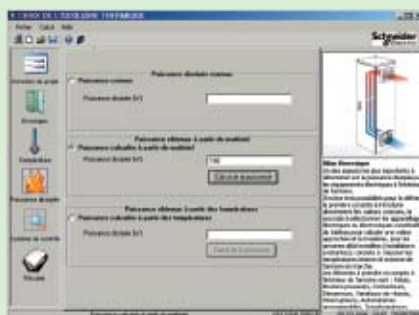

4 > Determine the power dissipated by the equipment. If this value is not known, ProClima can calculate it:

- According to the number and type of electric and electronic devices installed in the enclosure
- According to a temperature reading



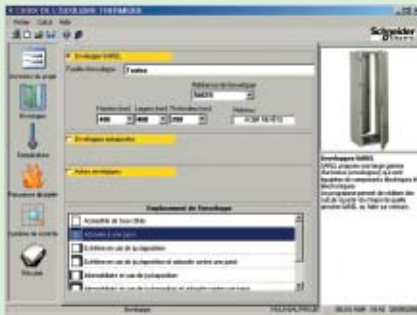

5 > Select the enclosure and the installation type

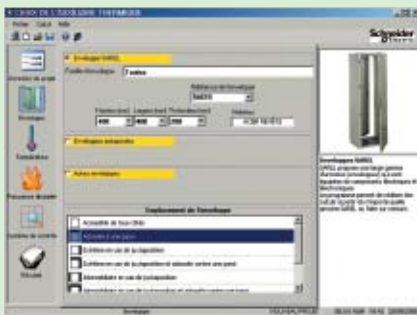

6 > Select the thermal management system

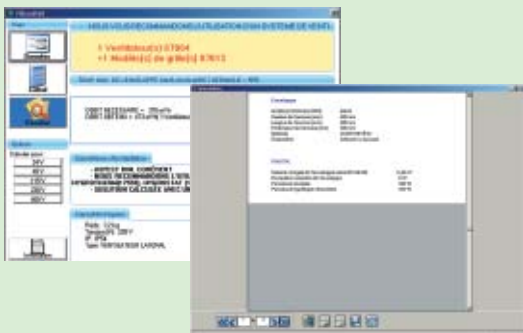

7 > View and print the study summary



- Reliable and accurate thermal study.
- Optimised solution.
- Saves time.
- User friendliness and ergonomics.
- Thermal values provided for all the most common devices on the market .





# Practical summary

# Good reflexes...

## ... for thermal management of enclosures



- **Previously visit the site and the area where the enclosure will be installed.**  
This will allow you to assess the external thermal conditions (before measuring them and analysing them closely).
- **Select the material that is best suited for the installation environment** and its natural thermal regulation features (e.g.: ventilated area, external air suitable for use in passive cooling, etc.).
- **Always analyse the thermal conditions inside and outside the enclosure, over a complete period and in different areas.**
- **Strictly observe the manufacturer's installation instructions:** installation area, mounting, wiring, dimensions of the airing spaces, etc.
- **Give priority to "Passive" thermal management solutions before considering any "Active" solutions.**

### Expert's tip

Plan thermal management (before installing the enclosure).

# Key figures for...

## ... thermal management of enclosures

### "Passive" Solutions

#### > Increasing the size of the enclosure

• Steel:

**52%**

*Energy savings*

**38°C**

*Temp. savings*

• Polyester:

**64%**

*Energy savings*

**60°C**

*Temp. savings*

#### > Insulation of a steel enclosure

**26%**

*Energy savings*

#### > Moving loads to the outside

**52%**

*Energy savings*

#### > Load distribution

**52%**

*Energy savings*

**25°C**

*Temp. savings*

# Key figures for...

## ... thermal management of enclosures

### "Active" Solutions

> Insulation of a polyester enclosure  
**12%**  
*Energy savings*

> Ventilation of an enclosure  
**58%**  
*Energy savings*  
**20°C**  
*Temp. savings*

Good thermal management can extend the service life of components and avoid expensive breakdowns.





# Choosing the best thermal management solution

# Selection guide

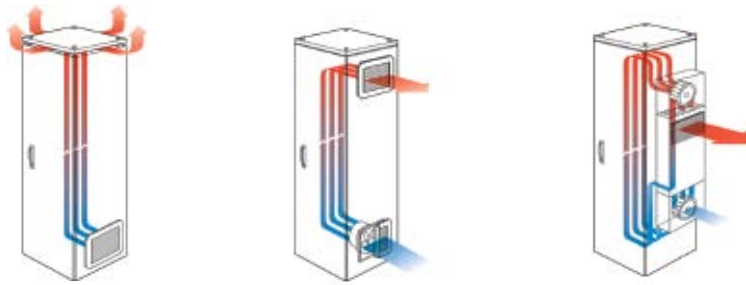



	Homogenize	Cooling		
Solution	Stirring	Natural ventilation	Forced ventilation	Air-air exchanger
<b>Description</b>	Stirring fan inside the enclosure.	Air circulation achieved by installing grids (side or roof-mounted) with or without filter, or by elevating the roof.	A fan (with or without filter) sucks fresh air from outside to inside the enclosure, thereby creating a slight overpressure which causes removal of the hot air through an outlet grid. The air circulation homogenizes the temperature and the overpressure prevents dust from entering. Side or roof mounting. Can be combined with a thermostat.	Cooling system provided with an aluminum exchange coil to separate the internal and external air circuits, two centrifugal fans to blow in the air circuits, and a thermostat to regulate the temperature in the enclosure. Side or roof mounting.
<b>Use</b>	Prevent hot spots.	Low power to be dissipated. Dusty environment.	High power to be dissipated. Dusty and non-hazardous environment. Prevent hot spots.	Medium power to be dissipated. Corrosive environment (food processing industry). Relatively cold environment (about 25°C).
<b>Temperature conditions*</b>	None	$T_d > T_a + 5^\circ\text{C}$	$T_d > T_a + 5^\circ\text{C}$ $3^\circ\text{C} < T_a \leq 35^\circ\text{C}$	$T_d > T_a + 5^\circ\text{C}$
<b>The internal and external air circuits must be independent?</b>	No	No	No	Yes
<b>Advantages</b>	<ul style="list-style-type: none"> <li>Uniform temperature inside the enclosure.</li> </ul>	<ul style="list-style-type: none"> <li>Very economical solution</li> <li>No maintenance</li> <li>Easy, fast installation.</li> </ul>	<ul style="list-style-type: none"> <li>Economical solution</li> <li>Easy maintenance</li> <li>Easy, fast installation</li> <li>Uniform temperature inside the enclosure</li> <li>Guaranteed level of protection: IP55 (IP54 for roof models).</li> </ul>	<ul style="list-style-type: none"> <li>Easy maintenance (no filter)</li> <li>Far lower maintenance frequency than for fans</li> <li>IP55 guaranteed.</li> </ul>
<b>Disadvantages</b>		<ul style="list-style-type: none"> <li>Low power dissipated</li> <li>Reduction in the degree of protection IP</li> <li>Risk of ingress of particles and dust if no filter.</li> </ul>	<ul style="list-style-type: none"> <li>Internal temperature always higher than the external temperature</li> <li>Maintenance required: change of filters.</li> </ul>	<ul style="list-style-type: none"> <li>Internal temperature always higher than the external temperature.</li> </ul>
<b>Illustration</b>				

\* $T_a$  = ambient temperature (outside the enclosure)  
 $T_d$  = desired temperature inside the enclosure

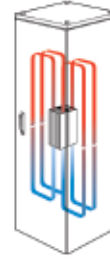
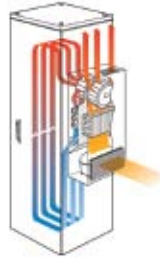
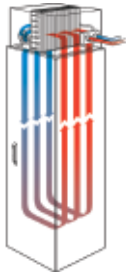



Cooling		Heating
<b>Air-water exchanger</b>	<b>Cooling unit</b>	<b>Heating resistor</b>
Cooling system provided with an exchange coil supplied with cold water and separated from the internal air circuit, a centrifugal fan for the air circuit, and a thermostat to regulate the temperature in the enclosure. Side or roof mounting.	Operates like a heat pump: A condenser removes to the ambient air the calories absorbed by an evaporator. The air inside the enclosure is thus cooled and dried. Side, floor or roof mounting.	The heating resistors prevent the formation of condensation and ensure an ideal temperature inside the enclosure.
Large quantity of heat to be removed. Difficult environments (cement plant, production lines, greasy workshops, etc.) or humid environments (sewage plant, bottling factory, etc.). Do not discharge calories into the environment.	Highly polluted environment but which permits the use of a filter for external protection of the cooling unit. Do not use ambient air in the cooling circuit.	To heat the inside of the enclosure and prevent condensation.
<b>Ta &gt; Td</b>	<b>Ta &gt; Td et Ta ≤ 55°C</b>	<b>Ta &lt; Td</b>
<b>Yes</b>	<b>Yes</b>	-
<ul style="list-style-type: none"> <li>■ Internal temperature independent of the external temperature</li> <li>■ Security system against any leaks</li> <li>■ Calories dissipated outside</li> <li>■ Guaranteed level of protection: IP55 (IP54 for roof models).</li> </ul>	<ul style="list-style-type: none"> <li>■ Internal temperature independent of the external temperature</li> <li>■ Uniform temperature inside the enclosure.</li> <li>■ Guaranteed level of protection: IP54 for roof and floor models, IP55 for side models and the SLIM range</li> <li>■ Use of an ecological gas.</li> </ul>	<ul style="list-style-type: none"> <li>■ Small size (1.6 mm thick for the ultra-thin version)</li> <li>■ Low surface temperature (&lt; 70°C for insulated version, 75°C for aluminum version)</li> <li>■ Uniform temperature inside the enclosure with the version equipped with a fan.</li> </ul>
<ul style="list-style-type: none"> <li>■ There must be a cold water circuit of stable temperature and flow rate</li> <li>■ Installation of special piping.</li> </ul>	<ul style="list-style-type: none"> <li>■ Installation of a system from removal of condensation water from the evaporator</li> <li>■ Maintenance required: change of filters.</li> </ul>	
 <p>Air-water exchanger</p>	 <p>Cooling unit</p>	 <p>Resistance heaters</p>

# Selection guide

## Ventilation systems with filters

Fan flow rate (m³/h)			Voltage (V)	Forced ventilation											
Free with filter	With 1 outlet grille	With 2 outlet grilles		Fan with filter		Outlet grille		EMC cover							
50 Hz	50 Hz	50 Hz		IP54 - RAL 7035	IP54 - RAL 7032	IP55	Inox IP55	EMC							
38	25	33	230	NSYCVF38M230PF	NSYCVF38M115PF	NSYCVF38M24DPF	NSYCVF38M48DPF	NSYCVF38M230PF	NSYCVF38M115PF	NSYCVF38M24DPF	NSYCVF38M48DPF	NSYCVF38M230PF	NSYCVF38M115PF	NSYCVF38M24DPF	NSYCVF38M48DPF
38	27	35	115	NSYCVF38M115PF	NSYCVF38M115PF	NSYCVF38M24DPF	NSYCVF38M48DPF	NSYCVF38M230PF	NSYCVF38M115PF	NSYCVF38M24DPF	NSYCVF38M48DPF	NSYCVF38M230PF	NSYCVF38M115PF	NSYCVF38M24DPF	NSYCVF38M48DPF
58	39	47	24 DC	NSYCVF38M24DPF	NSYCVF38M115PF	NSYCVF38M24DPF	NSYCVF38M48DPF	NSYCVF38M230PF	NSYCVF38M115PF	NSYCVF38M24DPF	NSYCVF38M48DPF	NSYCVF38M230PF	NSYCVF38M115PF	NSYCVF38M24DPF	NSYCVF38M48DPF
44	34	41	48 DC	NSYCVF38M48DPF	NSYCVF38M115PF	NSYCVF38M24DPF	NSYCVF38M48DPF	NSYCVF38M230PF	NSYCVF38M115PF	NSYCVF38M24DPF	NSYCVF38M48DPF	NSYCVF38M230PF	NSYCVF38M115PF	NSYCVF38M24DPF	NSYCVF38M48DPF
85	63	71	230	NSYCVF85M230PF	NSYCVF85M115PF	NSYCVF85M24DPF	NSYCVF85M48DPF	NSYCVF85M230PF	NSYCVF85M115PF	NSYCVF85M24DPF	NSYCVF85M48DPF	NSYCVF85M230PF	NSYCVF85M115PF	NSYCVF85M24DPF	NSYCVF85M48DPF
79	65	73	115	NSYCVF85M115PF	NSYCVF85M115PF	NSYCVF85M24DPF	NSYCVF85M48DPF	NSYCVF85M230PF	NSYCVF85M115PF	NSYCVF85M24DPF	NSYCVF85M48DPF	NSYCVF85M230PF	NSYCVF85M115PF	NSYCVF85M24DPF	NSYCVF85M48DPF
80	57	77	24 DC	NSYCVF85M24DPF	NSYCVF85M115PF	NSYCVF85M24DPF	NSYCVF85M48DPF	NSYCVF85M230PF	NSYCVF85M115PF	NSYCVF85M24DPF	NSYCVF85M48DPF	NSYCVF85M230PF	NSYCVF85M115PF	NSYCVF85M24DPF	NSYCVF85M48DPF
79	59	68	48 DC	NSYCVF85M48DPF	NSYCVF85M115PF	NSYCVF85M24DPF	NSYCVF85M48DPF	NSYCVF85M230PF	NSYCVF85M115PF	NSYCVF85M24DPF	NSYCVF85M48DPF	NSYCVF85M230PF	NSYCVF85M115PF	NSYCVF85M24DPF	NSYCVF85M48DPF
165	153	161	230	NSYCVF165M230PF	NSYCVF165M115PF	NSYCVF165M24DPF	NSYCVF165M48DPF	NSYCVF165M230PF	NSYCVF165M115PF	NSYCVF165M24DPF	NSYCVF165M48DPF	NSYCVF165M230PF	NSYCVF165M115PF	NSYCVF165M24DPF	NSYCVF165M48DPF
164	153	161	115	NSYCVF165M115PF	NSYCVF165M115PF	NSYCVF165M24DPF	NSYCVF165M48DPF	NSYCVF165M230PF	NSYCVF165M115PF	NSYCVF165M24DPF	NSYCVF165M48DPF	NSYCVF165M230PF	NSYCVF165M115PF	NSYCVF165M24DPF	NSYCVF165M48DPF
188	171	179	24 DC	NSYCVF165M24DPF	NSYCVF165M115PF	NSYCVF165M24DPF	NSYCVF165M48DPF	NSYCVF165M230PF	NSYCVF165M115PF	NSYCVF165M24DPF	NSYCVF165M48DPF	NSYCVF165M230PF	NSYCVF165M115PF	NSYCVF165M24DPF	NSYCVF165M48DPF
193	171	179	48 DC	NSYCVF165M48DPF	NSYCVF165M115PF	NSYCVF165M24DPF	NSYCVF165M48DPF	NSYCVF165M230PF	NSYCVF165M115PF	NSYCVF165M24DPF	NSYCVF165M48DPF	NSYCVF165M230PF	NSYCVF165M115PF	NSYCVF165M24DPF	NSYCVF165M48DPF
302	260	268	230	NSYCVF300M230PF	NSYCVF300M115PF	NSYCVF300M24DPF	NSYCVF300M48DPF	NSYCVF300M230PF	NSYCVF300M115PF	NSYCVF300M24DPF	NSYCVF300M48DPF	NSYCVF300M230PF	NSYCVF300M115PF	NSYCVF300M24DPF	NSYCVF300M48DPF
302	263	271	115	NSYCVF300M115PF	NSYCVF300M115PF	NSYCVF300M24DPF	NSYCVF300M48DPF	NSYCVF300M230PF	NSYCVF300M115PF	NSYCVF300M24DPF	NSYCVF300M48DPF	NSYCVF300M230PF	NSYCVF300M115PF	NSYCVF300M24DPF	NSYCVF300M48DPF
262	221	229	24 DC	NSYCVF300M24DPF	NSYCVF300M115PF	NSYCVF300M24DPF	NSYCVF300M48DPF	NSYCVF300M230PF	NSYCVF300M115PF	NSYCVF300M24DPF	NSYCVF300M48DPF	NSYCVF300M230PF	NSYCVF300M115PF	NSYCVF300M24DPF	NSYCVF300M48DPF
247	210	218	48 DC	NSYCVF300M48DPF	NSYCVF300M115PF	NSYCVF300M24DPF	NSYCVF300M48DPF	NSYCVF300M230PF	NSYCVF300M115PF	NSYCVF300M24DPF	NSYCVF300M48DPF	NSYCVF300M230PF	NSYCVF300M115PF	NSYCVF300M24DPF	NSYCVF300M48DPF
562	473	481	230	NSYCVF560M230PF	NSYCVF560M115PF	NSYCVF560M24DPF	NSYCVF560M48DPF	NSYCVF560M230PF	NSYCVF560M115PF	NSYCVF560M24DPF	NSYCVF560M48DPF	NSYCVF560M230PF	NSYCVF560M115PF	NSYCVF560M24DPF	NSYCVF560M48DPF
582	485	494	115	NSYCVF560M115PF	NSYCVF560M115PF	NSYCVF560M24DPF	NSYCVF560M48DPF	NSYCVF560M230PF	NSYCVF560M115PF	NSYCVF560M24DPF	NSYCVF560M48DPF	NSYCVF560M230PF	NSYCVF560M115PF	NSYCVF560M24DPF	NSYCVF560M48DPF
838	718	728	230	NSYCVF850M230PF	NSYCVF850M115PF	NSYCVF850M24DPF	NSYCVF850M48DPF	NSYCVF850M230PF	NSYCVF850M115PF	NSYCVF850M24DPF	NSYCVF850M48DPF	NSYCVF850M230PF	NSYCVF850M115PF	NSYCVF850M24DPF	NSYCVF850M48DPF
983	843	854	115	NSYCVF850M115PF	NSYCVF850M115PF	NSYCVF850M24DPF	NSYCVF850M48DPF	NSYCVF850M230PF	NSYCVF850M115PF	NSYCVF850M24DPF	NSYCVF850M48DPF	NSYCVF850M230PF	NSYCVF850M115PF	NSYCVF850M24DPF	NSYCVF850M48DPF
931	798	809	400	NSYCVF850M400PF	NSYCVF850M115PF	NSYCVF850M24DPF	NSYCVF850M48DPF	NSYCVF850M230PF	NSYCVF850M115PF	NSYCVF850M24DPF	NSYCVF850M48DPF	NSYCVF850M230PF	NSYCVF850M115PF	NSYCVF850M24DPF	NSYCVF850M48DPF

## Resistance heaters



Insulated resistance heater with fan		
Power (W)	Voltage (V)	Reference
177	230 CA	NSYCR170W230VVC



Thermofans		
Power (W)	Voltage (V)	Reference
400/550	120 AC	NSYCRP1W120VTV
400/550	230 AC	NSYCRP1W230VTV



Ultra thin resistance heaters			
Power (W)	Voltage (V)	Dimensions (mm)	Reference
10	120	130 X 250 X 1.6	NSYCRS10W120V
10	240	130 X 250 X 1.6	NSYCRS10W240V
25	120	130 X 250 X 1.6	NSYCRS25W120V
25	240	130 X 250 X 1.6	NSYCRS25W240V
50	120	200 X 320 X 1.6	NSYCRS50W120V
50	240	200 X 320 X 1.6	NSYCRS50W240V
100	120	280 X 450 X 1.6	NSYCRS100W120V
100	240	280 X 450 X 1.6	NSYCRS100W240V
200	120	400 X 650 X 1.6	NSYCRS200W120V
200	240	400 X 650 X 1.6	NSYCRS200W240V



Resistance heaters aluminium		
Power (W)	Voltage (V)	Reference
<b>Power cord</b>		
10	12-24 DC	NSYCR10WU1
10	110-250 AC	NSYCR10WU2
20	12-24 DC	NSYCR20WU1
20	110-250 AC	NSYCR20WU2
<b>Terminal block</b>		
20	270-420 AC	NSYCR20WU3
55	12-24 DC	NSYCR55WU1
55	110-250 AC	NSYCR55WU2
55	270-420 AC	NSYCR55WU3
90	12-24 DC	NSYCR100WU1
90	110-250 AC	NSYCR100WU2
90	270-420 AC	NSYCR100WU3
150	12-24 DC	NSYCR150WU1
150	110-250 AC	NSYCR150WU2
150	270-420 AC	NSYCR150WU3



Insulated PTC heaters		
Power (W)	Voltage (V)	Reference
10	12-24 DC	NSYCR10WU1C
10	110-250 AC	NSYCR10WU2C
20	12-24 DC	NSYCR20WU1C
20	110-250 AC	NSYCR20WU2C
55	12-24 DC	NSYCR50WU1C
55	110-250 AC	NSYCR50WU2C
55	270-420 AC	NSYCR50WU3C
100	12-24 DC	NSYCR100WU1C
100	110-250 AC	NSYCR100WU2C
100	270-420 AC	NSYCR100WU3C
147	12-24 DC	NSYCR150WU1C
147	110-250 AC	NSYCR150WU2C



Resistance heaters with fan		
Power (W)	Voltage (V)	Reference
250	115 AC	NSYCR250W115VV
250	230 AC	NSYCR250W230VV
400	115 AC	NSYCR400W115VV
400	230 AC	NSYCR400W230VV
200	115 AC	NSYCRS200W115V
200	230 AC	NSYCRS200W230V

## Control temperature



NC thermostat

Control a resistance heater or an alarm	
Setting range	Reference
0...+60°C	<b>NSYCCOTHC</b>
+32...+140 °F	<b>NSYCCOTHCF</b>



Double thermostat

Control a resistance heater and a fan	
Setting range	Reference
0...+60°C	<b>NSYCCOTHHD</b>
+32...+140 °F	<b>NSYCCOTHDF</b>



Electronic thermostat

Control a resistance heater or a fan		
Setting range	Display	Reference
+5°C...	°C ou °F	<b>NSYCCOTH30VID</b>
+50°C		<b>NSYCCOTH120VID</b>
		<b>NSYCCOTH230VID</b>

7 different operating modes.  
Option of installing one or two external sensors.



Electronic hygostat

Control relative humidity		
Setting range	Display	Reference
20% ...80%	% RH	<b>NSYCCOHY30VID</b>
		<b>NSYCCOHY120VID</b>
		<b>NSYCCOHY230VID</b>

2 different operating modes.



NO thermostat

Control a fan or an alarm	
Setting range	Reference
0...+60°C	<b>NSYCCOTH0</b>
+32...+140 °F	<b>NSYCCOTH0F</b>



Thermostat with inverse contact

Control a resistance heater or a fan	
Setting range	Reference
0...+60°C	<b>NSYCCOTH1</b>
+32...+140 °F	<b>NSYCCOTH1F</b>



Electronic hygrotherm

Control temperature and relative humidity		
Setting range	Display	Reference
+5°C...	°C ou °F ou %RH	<b>NSYCCOHYT30VID</b>
+50°C		<b>NSYCCOHYT120VID</b>
		<b>NSYCCOHYT230VID</b>

3 different operating modes.  
Option of installing an external sensor.

## Detectors



Temperature sensor

External temperature sensor (double insulation)	
Reference	
<b>NSYCCASTE</b>	

## Dataloggers



Temperature recorder

Temperature recorder			
Temperature	RH <sup>(1)</sup>	Reference	Model
-40°C...+80°C	-	<b>NSYDTEF32T</b>	DTT

*(1) RH : Relative humidity (%)*



Temperature recorder

Single-use temperature recorder			
Temperature	RH <sup>(1)</sup>	Reference	Model
-40°C...+80°C	-	<b>NSYDTEF32T</b>	DTMinilog

*(1) RH : Relative humidity (%)*



Temperature recorder

Temperature, humidity and dew point recorder			
Temperature	RH <sup>(1)</sup>	Reference	Model
-40°C...+80°C	5% to 95%	<b>NSYDTEF32TRH</b>	DTH

*(1) RH : Relative humidity (%)*

## Thermal accessories for outdoor Heavy Duty enclosures



Fanbox	
Voltage (V)	Reference
24 DC	<b>NSYCVF550M24FB</b>
48 DC	<b>NSYCVF550M48FB</b>
115 AC	<b>NSYCVF550M115FB</b>
230 AC	<b>NSYCVF550M230FB</b>



Filter
Reference <b>NSYCAF223T</b>



Roof filter for fanbox
Reference <b>NSYCAF190</b>



IP55 HD Metal Grid
Reference <b>NSYAG223LFHD</b>



Anti-vandalism kit for HD metal grid
Reference <b>NSYCAAPVHD</b>

# Selection guide

## Air-air exchangers



Characteristics	Side-mounting models			
<b>Cooling characteristics</b>				
Specific power (W/K)	22	36	50	80
<b>References</b>				
	NSYCEA22E	NSYCEA36	NSYCEA50	NSYCEA80

## Air-water exchangers



Characteristics	Side-mounting models					
<b>Cooling characteristics</b>						
Cooling power W10A35	1000 W	1750 W	2500 W	3500 W	4500 W	6000 W
<b>References</b>						
Steel	NSYCEW1K	NSYCEW1K8	NSYCEW2K5	NSYCEW3K5	NSYCEW4K5	NSYCEW6K
Stainless steel	NSYCEWX1K	NSYCEWX1K8	NSYCEWX2K5	NSYCEWX3K5	NSYCEWX4K5	NSYCEWX6K
Steel UL	NSYCEW1KUL	NSYCEW1K8UL	NSYCEW2K5UL	NSYCEW3K5UL	NSYCEW4K5UL	NSYCEW6KUL
Stainless steel UL	NSYCEWX1KUL	NSYCEWX1K8UL	NSYCEWX2K5UL	NSYCEWX3K5UL	NSYCEWX4K5UL	NSYCEWX6KUL

## Cooling units



Characteristics	Side-mounting models				
<b>Cooling characteristics</b>					
Cooling power L35-L35	300 W (1024 Btu/h)	380 W (1297 Btu/h)	640 W (2184 Btu/h)	820 W (2798 Btu/h)	1000 W (3412 Btu/h)
Cooling power L35-L50	150 W (512 Btu/h)	240 W (819 Btu/h)	470 W (1604 Btu/h)	680 W (2320 Btu/h)	790 W (2696 Btu/h)
<b>References</b>					
Steel	NSYCU300H	NSYCU400	NSYCU600	NSYCU800	NSYCU1K
Stainless steel	-	NSYCUX400	NSYCUX600	NSYCUX800	NSYCUX1K
Steel UL	-	NSYCU400UL	NSYCU600UL	NSYCU800UL	NSYCU1KUL
Stainless steel UL	-	-	NSYCUX600UL	NSYCUX800UL	NSYCUX1KUL



Characteristics	Side-mounting models			Floor-standing models	
<b>Cooling characteristics</b>					
Cooling power L35-L35	2000 W (6824 Btu/h)	2900 W (9895 Btu/h)	3850 W (13137 Btu/h)	5800 W (19790 Btu/h)	6050 W (20643 Btu/h)
Cooling power L35-L50	1510 W (5152 Btu/h)	2250 W (7677 Btu/h)	2870 W (9793 Btu/h)	4350 W (14843 Btu/h)	4350 W (14843 Btu/h)
<b>References</b>					
Steel	NSYCU2K3P4	NSYCU3K3P4	NSYCU4K3P4	NSYCU6K3P4	NSYCU6K3P460
Stainless steel	NSYCUX2K3P4	NSYCUX3K3P4	NSYCUX4K3P4	-	-
Steel UL	NSYCU2K3P4UL	NSYCU3K3P4UL	NSYCU4K3P4UL	-	-
Stainless steel UL	NSYCUX2K3P4UL	NSYCUX3K3P4UL	NSYCUX4K3P4UL	-	-



Characteristics	Top-mounting models				
<b>Cooling characteristics</b>					
Cooling power L35-L35	410 W (1399 Btu/h)	820 W (2798 Btu/h)	1150 W (3924 Btu/h)	1550 W (5289 Btu/h)	2050 W (6995 Btu/h)
Cooling power L35-L50	240 W (819 Btu/h)	680 W (2320 Btu/h)	900 W (3071 Btu/h)	1200 W (4095 Btu/h)	1560 W (5323 Btu/h)
<b>References</b>					
Steel	NSYCU400R	NSYCU800R	NSYCU1K2R	NSYCU1K5R	NSYCU2KR
Stainless steel	NSYCUX400R	NSYCUX800R	NSYCUX1K2R	NSYCUX1K5R	NSYCUX2KR
Steel UL	NSYCU400RUL	NSYCU800RUL	NSYCU1K2RUL	NSYCU1K5RUL	-

## Outdoor Heavy Duty cooling units



Characteristics	Side-mounting models				
<b>Cooling characteristics</b>					
Cooling power L35-L35	380 W (1297 Btu/h)	640 W (2184 Btu/h)	820 W (2798 Btu/h)	1000 W (3412 Btu/h)	1000 W (3412 Btu/h)
Cooling power L35-L50	240 W (819 Btu/h)	470 W (1604 Btu/h)	680 W (2320 Btu/h)	790 W (2696 Btu/h)	790 W (2696 Btu/h)
<b>References</b>					
	NSYCUHD400	NSYCUHD600	NSYCUHD800	NSYCUHD1K	NSYCUHD1K2P4

## Slim cooling units



Characteristics	Side-mounting models				
<b>Cooling characteristics</b>					
Cooling power L35-L35	1100 W (3753 Btu/h)	1100 W (3753 Btu/h)	1500 W (5118 Btu/h)	1500 W (5118 Btu/h)	2000 W (6824 Btu/h)
Cooling power L35-L50	860 W (2934 Btu/h)	860 W (2934 Btu/h)	1150 W (3924 Btu/h)	1150 W (3924 Btu/h)	1550 W (5289 Btu/h)
<b>References</b>					
Steel UL	NSYCUS1K1UL	NSYCUS1K12P4UL	NSYCUS1K5UL	NSYCUS1K52P4UL	NSYCUS2KUL
Stainless steel UL	NSYCUSX1K1UL	NSYCUSX1K12P4UL	NSYCUSX1K5UL	NSYCUSX1K52P4UL	NSYCUSX2KUL

6000 W	10000 W	10000 W	15000 W	15000 W
<b>NSYCEW6K2P4</b>	<b>NSYCEW10K</b>	<b>NSYCEW10K2P4</b>	<b>NSYCEW15K</b>	<b>NSYCEW15K2P4</b>
<b>NSYCEWX6K2P4</b>	<b>NSYCEWX10K</b>	<b>NSYCEWX10K2P4</b>	<b>NSYCEWX15K</b>	<b>NSYCEWX15K2P4</b>
-	-	-	-	-
-	-	-	-	-



<b>Top-mounting models</b>
2500 W
<b>NSYCEW2K5R</b>
-
-
-

1000 W (3412 Btu/h)	1250 W (4265 Btu/h)	1250 W (4265 Btu/h)	1600 W (5459 Btu/h)	1600 W (5459 Btu/h)	2000 W (6824 Btu/h)
790 W (2696 Btu/h)	910 W (3105 Btu/h)	910 W (3105 Btu/h)	1230 W (4197 Btu/h)	1230 W (4197 Btu/h)	1510 W (5152 Btu/h)
<b>NSYCU1K2P4</b>	<b>NSYCU1K2</b>	<b>NSYCU1K22P4</b>	<b>NSYCU1K6</b>	<b>NSYCU1K62P4</b>	<b>NSYCU2K</b>
<b>NSYCUX1K2P4</b>	<b>NSYCUX1K2</b>	<b>NSYCUX1K22P4</b>	<b>NSYCUX1K6</b>	<b>NSYCUX1K62P4</b>	<b>NSYCUX2K</b>
<b>NSYCU1K2P4UL</b>	<b>NSYCU1K2UL</b>	-	<b>NSYCU1K6UL</b>	<b>NSYCU1K62P4UL</b>	<b>NSYCU2KUL</b>
<b>NSYCUX1K2P4UL</b>	<b>NSYCUX1K2UL</b>	-	<b>NSYCUX1K6UL</b>	<b>NSYCUX1K62P4UL</b>	<b>NSYCUX2KUL</b>

7600 W (25932 Btu/h)	7950 W (27126 Btu/h)	9400 W (32074 Btu/h)	9850 W (33610 Btu/h)	14800 W (50500 Btu/h)	15150 W (51694 Btu/h)
5700 W (19449 Btu/h)	5930 W (20234 Btu/h)	7000 W (23885 Btu/h)	7350 W (25079 Btu/h)	11300 W (38557 Btu/h)	11600 W (39581 Btu/h)
<b>NSYCU8K3P4</b>	<b>NSYCU8K3P460</b>	<b>NSYCU10K3P4</b>	<b>NSYCU10K3P460</b>	<b>NSYCU15K3P4</b>	<b>NSYCU15K3P460</b>
-	-	-	-	-	-
-	-	-	-	-	-
-	-	-	-	-	-

2050 W (6995 Btu/h)	2900 W (9895 Btu/h)	3850 W (13137 Btu/h)
1560 W (5323 Btu/h)	2250 W (7677 Btu/h)	2870 W (9793 Btu/h)
<b>NSYCU2K3P4R</b>	<b>NSYCU3K3P4R</b>	<b>NSYCU4K3P4R</b>
<b>NSYCUX2K3P4R</b>	<b>NSYCUX3K3P4R</b>	<b>NSYCUX4K3P4R</b>
<b>NSYCU2K3P4RUL</b>	<b>NSYCU3K3P4RUL</b>	<b>NSYCU4K3P4RUL</b>

1600 W (5459 Btu/h)	1600 W (5459 Btu/h)	2000 W (6824 Btu/h)	2900 W (9895 Btu/h)	3850 W (13137 Btu/h)
1230 W (4197 Btu/h)	1230 W (4197 Btu/h)	1510 W (5152 Btu/h)	2250 W (7677 Btu/h)	2870 W (9793 Btu/h)
<b>NSYCUHD1K6</b>	<b>NSYCUHD1K62P4</b>	<b>NSYCUHD2K3P4</b>	<b>NSYCUHD3K3P4</b>	<b>NSYCUHD4K3P4</b>

2000 W (6824 Btu/h)	2500 W (8530 Btu/h)	2500 W (8530 Btu/h)	3200 W (10919 Btu/h)	3200 W (10919 Btu/h)
1550 W (5289 Btu/h)	1850 W (6312 Btu/h)	1850 W (6312 Btu/h)	2500 W (8530 Btu/h)	2500 W (8530 Btu/h)
<b>NSYCUS2K3P4UL</b>	<b>NSYCUS2K5UL</b>	<b>NSYCUS2K53P4UL</b>	<b>NSYCUS3K2UL</b>	<b>NSYCUS3K23P4UL</b>
<b>NSYCUSX2K3P4UL</b>	<b>NSYCUSX2K5UL</b>	<b>NSYCUSX2K53P4UL</b>	<b>NSYCUSX3K2UL</b>	<b>NSYCUSX3K23P4UL</b>

# Thermal solutions & atmosphere

## Table of atmosphere selection and associated thermal solutions

Enclosure localisation	Main problems resulting from aggressiveness or severity of the installation site							
	Dust	Presence of high humidity level or water	Oil	Aggressive chemical agents (1)	Ambiant temperature > 35°C	Vibration	Heat radiation	Electromagnetic compatibility (2)
Paper or wood industry	x	x		x				
Textile	x	x		x	x			
Rubber	x			x	x			
Automotive	x		x		x			
Nuclear	x	x		x				
Food-processing (lactic, sugar, beer, etc.)	x	x		x				
Chemicals	x							
Foundry (glass, metal etc.)	x				x		x	
Transport	x							
Treatment of water or water source, pumping	x	x						
Recycling	x	x						
Packaging	x							
Cementary	x							
Hoisting	x	x				x		
Conveying	x	x				x		
Closed premises low-volume	x				x			
Very hot location	x	x			x			
Outdoors	x	x			x		x	
Sheet metal industry	x	x	x					
Telecoms	x	x			x		x	x

(1) See chemical agents table, etc.

(2) Electromagnetic compatibility problems may also occur due to installed equipment, see recommendations and solutions (to follow).

"Active" solutions						
Enclosure localisation	Stirring inside the enclosure	Forced ventilation with filter	Air-air exchangers	Cooling Units	Air-water exchangers	heating resistors
Paper or wood industry		x		x	x	x
Textile		x		x	x	x
Rubber				x		
Automotive		x (If ventilation used, must use OEM filters for atmospheres where oil is present)		x		
Nuclear		x	x	x		x
Food-processing (lactic, sugar, beer, etc.)	x	x	x			x
Chemicals	x					
Foundry (glass, metal etc.)						
Transport						
Treatment of water or water source, pumping						x
Recycling				x	x	x
Packaging	x	x		x		
Cementary	x					
Hoisting	x	x		x		x
Conveying	x	x		x		x
Closed premises low-volume	x					
Very hot location						x
Outdoors	x	x	x	x		x
Sheet metal industry	x	x		x	x	x
Telecoms		x	x	x		x
<b>The benefits of use for each solution</b>	Gives uniform temperature inside your cabinet and avoids hot spots (temporary heating). In addition, if external temperature is favourable (<35°C), this significantly favours passive and sealed heat extraction (up to IP66).	The most efficient solution if external temperature is favourable (<35°C) and below a minimum of 3°C (to cool down). Air is more efficient and is free!	Only effective if external conditions are very favourable (installed in air-conditioned rooms or industries with presence of dust particles)	Can be used in polluted atmospheres and external temperatures above 35°C, so where it is not possible to ventilate nor use air-air exchangers.	Exchangers are used in very polluted atmospheres where air conditioning is impossible. They are also very effective in places where there is a lot of condensation.	Resistances are used to avoid condensation problems and maintain humidity levels at approximately 60% (recommended).
<b>Constraints</b>		Filter maintenance. A lack of filter maintenance leads to filter blockage and a reduction in flow and performance.	Low heat extraction power indoors. They rely on a high dT (minimum 10°C) to be effective.	Considerable energy consumption and filter maintenance required to prevent drop in performance of cooling units. Example: mineral water production. It is the most watertight solution.	Reliant on a chilled water source (or a chiller or a water source). Water must be filtered in order not to block the exchanger.	
<b>Power of extraction with an equal volume</b>	500-1000 W (*)	3000 W (*)	1000 W (*)	4000 W	4000 W	

(\*) Performances dependent on favourable external temperatures (more dT, better performances).







# Technical appendix

# Heat exchanges

## Principle

There are three modes of transfer of heat inside a switchboard:

- conduction,
- convection,
- radiation.

Controlling these phenomena makes it possible to:

- reduce temperature rises inside the switchboard,
- optimise the performance of the devices installed in the switchboard.

## Conduction

Conduction is the transfer of heat caused by the difference in temperature between two regions of the same environment or two environments in contact without the movement of matter.

It is a slow phenomenon that can be interpreted as the cumulative transmission of heat agitation.

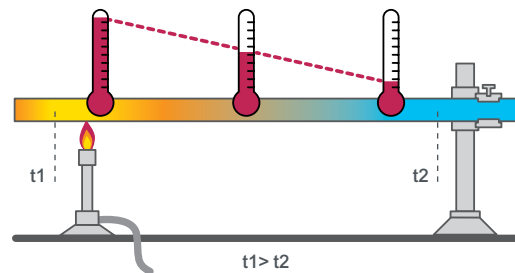

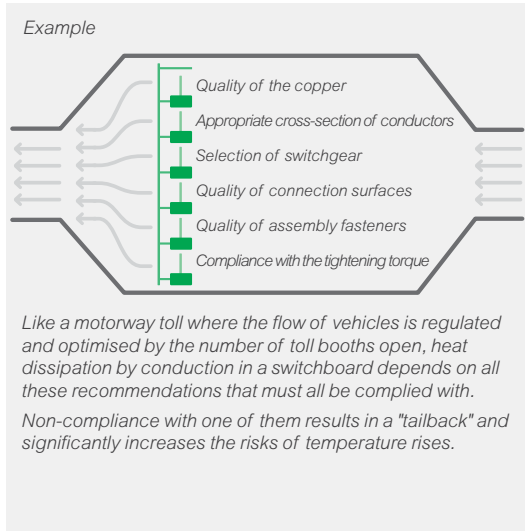

## Conduction (contd.)

### Good practice

The heat transfer mode that acts spontaneously inside a switchboard and has the strongest impact on the thermal balance of the assembly is conduction. It is therefore essential not to alter heat dissipation by conduction by:

- selecting materials of excellent quality (copper or aluminium),
- correctly defining the cross-section of conductors (main busbars, insulated flexible bars, cables),
- selecting devices with known and tested characteristics that are compatible with the enclosure in which they will be installed,
- carefully preparing the connection surfaces (cleanliness, condition) and complying with covering rules (covering 3 to 5 times the thickness of the bar),
- using the appropriate fasteners (class 8.8 ungreased zinc-plated dichromatic fasteners (Zn8C)),
- complying with recommended tightening torques to obtain a good contact pressure.

 All these recommendations interact on the quality of heat exchanges via conduction inside the switchboard.

A cable connected to a device makes it possible to evacuate calories. The cable cross-section must therefore be chosen with this characteristic in mind. (See figure below)

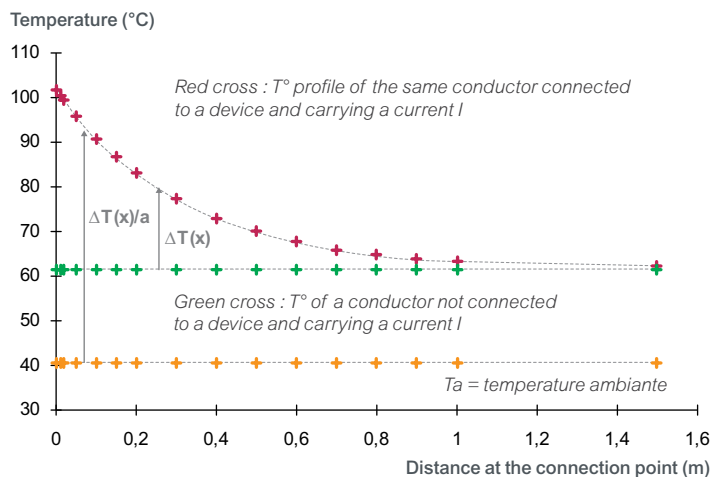

# Heat exchanges

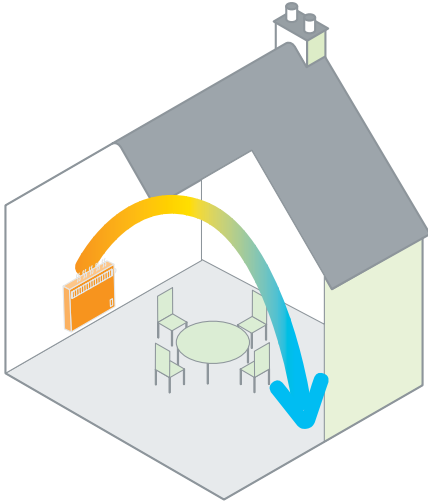

## Convection

Convection is a heat transfer mode that takes place only in gaseous and liquid environments. Unlike conduction, it involves a movement of matter in the environment.

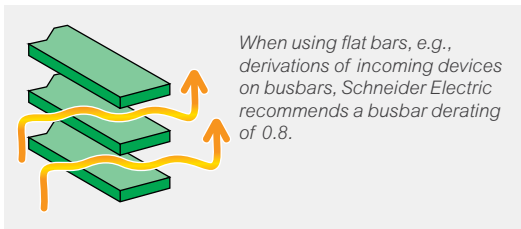

## Good practice

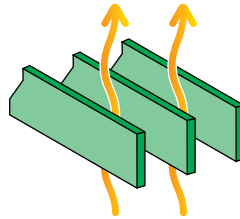

To favour heat dissipation by convection, it is essential to install the bars edgewise.

To correct the thermal status of the switchboard, there are several possibilities based on heat dissipation by convection:

- natural ventilation,
- forced ventilation,
- air-conditioning.

## Natural airing

Natural airing or natural convection is the switchboard heat exchange solution that is usually sufficient when the calorific value to dissipate is low and the equipment is installed in an environment with little pollution.

Switchboard systems are examined per construction to encourage the circulation of air inside the column.

If ventilation grids are installed on the upper and lower part of the switchboard, the cross-section of the upper opening must be at least 1.1 times the cross-section of the lower opening.

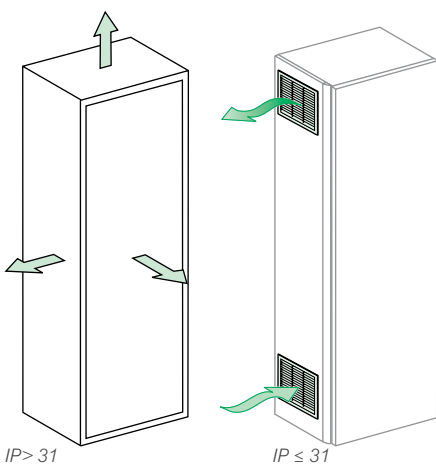

Make sure that no equipment (switchgear, metal parts, etc.) do not block the circulation of air from the ventilation louve openings (grids, etc.). These should be compatible with the degree of protection required by the column.

## ! Tip

Natural airing ensures the correct operation of switchboards in most cases.

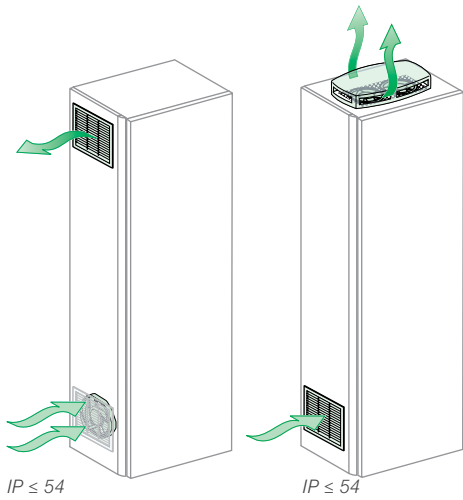

## Convection (contd.)

### Forced ventilation

Some conditions (high protection rating, installation of switchgear with very high heat dissipation such as soft starters, condenser batteries, etc.) generate high temperature rises that require the use of forced ventilation.

This solution is used to evacuate a larger quantity of heat, by extraction or drive of large quantities of air. This is done when the equipment is installed in an environment that is not very polluted.

The forced ventilation solution improves heat exchanges within the switchboard and therefore has effects on the optimisation of the switchgear, the conductors and the volume of the enclosure in certain cases.

Schneider Electric proposes ventilation kits to be mounted on the enclosure roof.

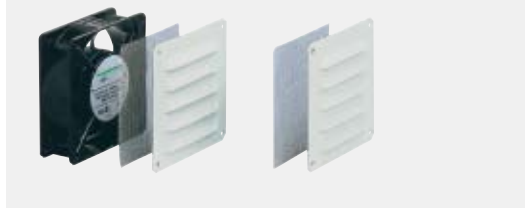

For polluted environments, the switchboard must be installed in an electrical room fitted with filters to avoid injecting the polluted air into the column.

In some cases (control/command switchboards), the quantity of heat to evacuate is much higher.

In this case there are several solutions:

- **Air-Air exchangers** are fitted with an aluminium exchange battery that separates the internal and external air circuits and prevent the ingress of dust.
- **Air-Water exchangers** lower the internal temperature of the enclosure through an exchange battery supplied in cold water. The temperature inside the enclosure is regulated by a thermostat that opens and closes a solenoid valve.
- **Air-conditioners** are systems that effectively cool the enclosure, independently of outside air. They serve to prevent hot spots. Cooling units may be used in more severe environments where the temperature may go up to 55°C. Devices integrate a regulation of the temperature of the envelope as well as an alarm function that reports an operating defect.

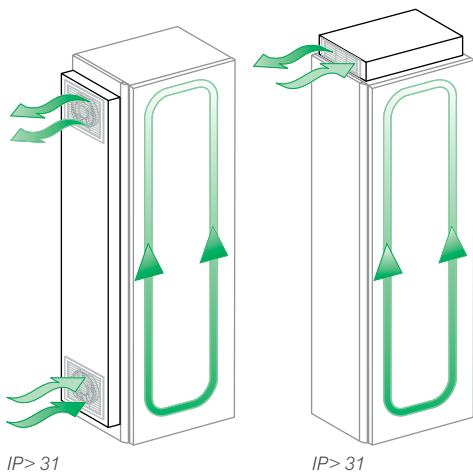

# Heat exchanges

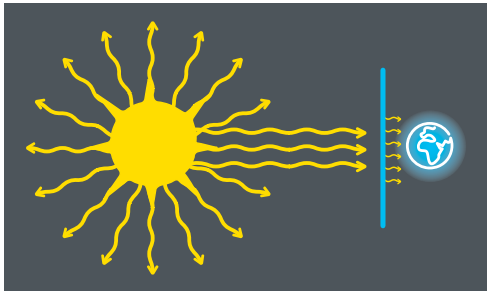

Example of universal and vital radiation: solar radiation.

## Radiation

Heat is propagated in the form of electromagnetic waves emitted by a hot body.

This phenomenon is practically immediate and, unlike conduction and convection, does not require a material medium for transporting the calories.

The power radiated by a body is proportional to its emissivity coefficient (comprised between 0 and 1) depending on the surface state of the material:

- Aluminium bar: 0.05
- Anodised aluminium: 0.7 to 0.8
- Polished copper: 0.03
- Weathered copper: 0.3 to 0.7
- Tin-plated or silver-plated copper: 0.3
- Painted copper: 0.9
- Insulated copper: 0.9

It also depends on the exchange surface, the surface temperature and the ambient temperature (Stefan-Boltzmann law).

## Good practice

For the same conductor cross-section, an epoxy paint coating can improve the conductor's capacity to transport current by 15 %.

To improve the radiation power of main busbars and thus reduce temperature rises, it is recommended to paint the bars with epoxy paint.

Connection surfaces must not be painted to ensure a good electrical contact. Provide for an additional resist around the connection zone. The size of this resist depends on the bar cross-section and the type of connection (horizontal/vertical busbar connection, joining of two horizontal busbars).

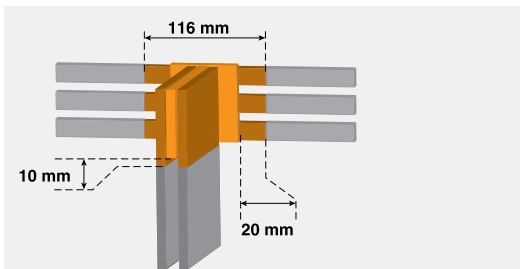

Epoxy protection on H-BB/V-BB115 connections. Provide for a 116 mm resist on the 40 x 10 bars of the horizontal busbar for a connection with the vertical busbar.

# Operation constraints

## > Environmental conditions

### Principle

A switchboard is designed to operate in well-defined environmental conditions: ambient temperature, hygrometry, altitude, degree of pollution.

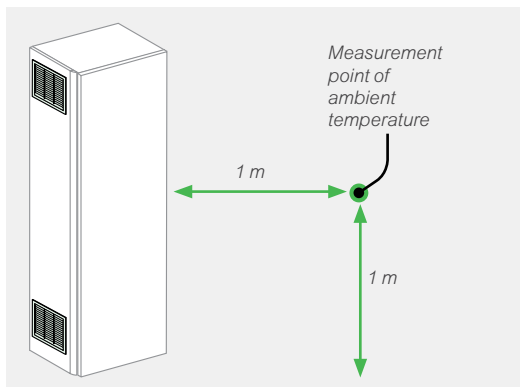

### Definition of ambient temperature

**Ambient temperature is the temperature measured at a distance and a height of 1 m from the switchboard.**

The ambient air temperature must be measured using at least two thermometers or thermocouples evenly distributed around the enclosure at approximately half its height and at a distance of approximately 1 m from the enclosure.

Thermometers and thermocouples must be protected from draught and heat radiation.



The ambient air temperature for an internal installation must comply with the following conditions:

- daily average of under +35°C,
- lower limit: -5°C,
- upper limit: +40°C.

### Hygrometry

The air must be clean and with a relative humidity that will not exceed 50 % at a maximum temperature of +40°C.

### Altitude

Precautions must be taken for switchboards that are to be installed at an altitude of over 2000 m.

It is important to take into account the reduction in electric strength of air, the breaking capacity of devices and the cooling capacity affected by the air density.

# Operation constraints

## Degree of pollution

Pollution is defined as the introduction of solid, liquid or gaseous foreign bodies that can reduce the dielectric strength or resistivity of the insulator surface.

There are four levels of pollution:

Level	Description
Pollution degree 1	No pollution or only dry, nonconductive pollution occurs. The pollution has no influence.
Pollution degree 2	Only non-conductive pollution occurs, except that occasionally a temporary conductivity caused by condensation is to be expected.
Pollution degree 3	Conductive pollution occurs, or dry, non-conductive pollution occurs which becomes conductive due to condensation is to be expected.
Pollution degree 4	The pollution generates persistent conductivity caused by conductive dust, rain or other humid conditions.

Generally, unless otherwise specified, assemblies for industrial applications are intended to be used in an environment with a pollution degree 3.

Creepage distances and clearances must be determined according to:

- the rated clearance voltage  $U_i$  of the table,
- the type of insulating material (which defines the material group),
- the pollution degree in the environment.



## > Temperature rise limits

- The temperature of a metal manual control device should never exceed 50°C (35°C + 15 K).
- The temperature of an external metal surface should never exceed 65°C (35°C + 30 K).



Temperature rises must not cause damage to the components through which the current passes or to adjacent components.

Temperature rise limits must be specified by the original manufacturer. They must be checked using one or more of the methods below:

- tests with current,
- deductions of characteristics based on a design subject to tests for similar solutions,
- calculations.



Some temperature values to comply with:

140°C	for main busbars (bare copper (35°C + 105 K))
125°C	for insulated flexible busbars (35°C + 90 K)
105°C	for terminals for insulated external conductors (35°C + 70 K)
65°C	for external metal surfaces (35°C + 30 K)
60°C	for manual control devices in insulating material (35°C + 25 K)

### ! Tip

35°C is the ambient temperature value taken as a reference and the value expressed in K is the maximum permissible temperature rise.

# Operation constraints

## > Confinement of the switchboard

*An IP55 protection rating confines much more than an IP30 rating: see standard IEC 60529.*

### Good practice

The degree of protection IP of a switchboard has a direct impact on its heat-dissipating capacity.

The higher the IP degree of protection, the more the switchboard is confined and the less it is able to evacuate heat. The temperature inside the switchboard will therefore rise.

Assembly builders provide tables that give the in situ performance of enclosures, devices and related conductors depending on the switchboard characteristics and environmental conditions.

These values must be taken into account when selecting busbars and the switchgear.

*A complete partition (form 4) dissipates less heat than a non-partitioned switchboard (form 1): see standard IEC 61439-2.*

The partitions installed for the forms limit heat dissipation through natural convection. They may cause temperature rises on devices and their connections (hottest points).

## > Internal temperature of the switchboard too low

### Good practice

For switchboards that are intended to be used in very humid locations and temperatures with wide variations, the appropriate measures must be taken (airing and/or internal heating, drainage holes, etc.) must be taken to prevent harmful condensation inside the switchboard.



Always make sure that the IP degree of protection is maintained.

The most common method for raising the internal temperature of a switchboard is heating with resistances.

It makes it possible:

- to avoid the formation of condensation water by limiting temperature variations,
- to protect the installation from frost.

Take the following precautions when installing heating resistances:

- heating resistances must not be installed too close to the switchgear.
- lay out and clamp the conductors in such a manner that they are sufficiently far from the heating element.

The air must be clean and its relative humidity must not exceed 50 % at a maximum temperature of +40°C. Higher levels of relative humidity may be accepted at lower temperatures, e.g. 90 % at +20°C.

You must take into account the slight condensation that may occur occasionally as a result of temperature variations.





**Schneider Electric Industries SAS**

35, rue Joseph Monier  
CS 30323  
92506 Rueil Malmaison Cedex  
France

RCS Nanterre 954 503 439  
Capital social 896 313 776€  
[www.schneider-electric.com](http://www.schneider-electric.com)

02-2017  
CPTG001\_EN

