

# PowerPact B-Frame Multistandard Circuit Breakers User Guide

12/2016



---

The information provided in this documentation contains general descriptions and/or technical characteristics of the performance of the products contained herein. This documentation is not intended as a substitute for and is not to be used for determining suitability or reliability of these products for specific user applications. It is the duty of any such user or integrator to perform the appropriate and complete risk analysis, evaluation and testing of the products with respect to the relevant specific application or use thereof. Neither Schneider Electric nor any of its affiliates or subsidiaries shall be responsible or liable for misuse of the information contained herein. If you have any suggestions for improvements or amendments or have found errors in this publication, please notify us.

No part of this document may be reproduced in any form or by any means, electronic or mechanical, including photocopying, without express written permission of Schneider Electric.

All pertinent state, regional, and local safety regulations must be observed when installing and using this product. For reasons of safety and to help ensure compliance with documented system data, only the manufacturer should perform repairs to components.

When devices are used for applications with technical safety requirements, the relevant instructions must be followed.

Failure to use Schneider Electric software or approved software with our hardware products may result in injury, harm, or improper operating results.

Failure to observe this information can result in injury or equipment damage.

© 2016 Schneider Electric. All Rights Reserved.

---

# Table of Contents

---



	<b>Safety Information</b> .....	<b>5</b>
	<b>About the Book</b> .....	<b>7</b>
<b>Chapter 1</b>	<b>PowerPact B-Frame Presentation</b> .....	<b>9</b>
	Feature Overview .....	<b>10</b>
	Device Overview .....	<b>11</b>
	Thermal-Magnetic Protection for Circuit Breakers .....	<b>14</b>
	Environmental Conditions .....	<b>15</b>
<b>Chapter 2</b>	<b>PowerPact B-Frame Insulation Requirements and Accessories</b> .....	<b>17</b>
	Insulation Accessories .....	<b>18</b>
	Clearance Requirements for PowerPact B-Frame Circuit Breakers .....	<b>19</b>
<b>Chapter 3</b>	<b>Operating the PowerPact B-Frame</b> .....	<b>23</b>
3.1	Operating a Circuit Breaker with a Toggle Handle .....	<b>24</b>
	Description .....	<b>25</b>
	Opening, Closing, Resetting, and Testing the Circuit Breaker .....	<b>27</b>
	Locking the Circuit Breaker .....	<b>29</b>
3.2	Operating a Circuit Breaker with a Direct Rotary Handle .....	<b>30</b>
	Description .....	<b>31</b>
	Opening, Closing, Resetting, and Testing the Circuit Breaker .....	<b>33</b>
	Locking the Circuit Breaker .....	<b>36</b>
3.3	Operating a Circuit Breaker with a Front Extended Rotary Handle .....	<b>39</b>
	Description .....	<b>40</b>
	Opening, Closing, Resetting, and Testing the Circuit Breaker .....	<b>41</b>
	Locking the Circuit Breaker .....	<b>45</b>
3.4	Operating a Circuit Breaker with a Side Rotary Handle .....	<b>48</b>
	Description .....	<b>49</b>
	Opening, Closing, Resetting, and Testing the Circuit Breaker .....	<b>50</b>
	Locking the Circuit Breaker .....	<b>52</b>
<b>Chapter 4</b>	<b>PowerPact B-Frame Electrical Auxiliary Devices</b> .....	<b>55</b>
	Electrical Auxiliary Devices .....	<b>56</b>
	Indication Contacts .....	<b>57</b>
	Control Auxiliaries .....	<b>58</b>
<b>Chapter 5</b>	<b>Commissioning and Maintaining the PowerPact B-Frame</b> .....	<b>59</b>
	Commissioning the Circuit Breaker .....	<b>60</b>
	Maintaining the Circuit Breaker During Operation .....	<b>62</b>
	Responding to a Trip .....	<b>64</b>
	Troubleshooting .....	<b>66</b>
<b>Appendices</b>	.....	<b>67</b>
<b>Appendix A</b>	<b>Wiring Diagrams</b> .....	<b>69</b>
	Circuit Breakers .....	<b>69</b>
<b>Index</b>	.....	<b>71</b>

---



## Important Information

### NOTICE

Read these instructions carefully, and look at the equipment to become familiar with the device before trying to install, operate, service, or maintain it. The following special messages may appear throughout this documentation or on the equipment to warn of potential hazards or to call attention to information that clarifies or simplifies a procedure.



The addition of this symbol to a “Danger” or “Warning” safety label indicates that an electrical hazard exists which will result in personal injury if the instructions are not followed.



This is the safety alert symbol. It is used to alert you to potential personal injury hazards. Obey all safety messages that follow this symbol to avoid possible injury or death.

### **DANGER**

**DANGER** indicates a hazardous situation which, if not avoided, **will result in** death or serious injury.

### **WARNING**

**WARNING** indicates a hazardous situation which, if not avoided, **could result in** death or serious injury.

### **CAUTION**

**CAUTION** indicates a hazardous situation which, if not avoided, **could result in** minor or moderate injury.

### **NOTICE**

**NOTICE** is used to address practices not related to physical injury.

### PLEASE NOTE

Electrical equipment should be installed, operated, serviced, and maintained only by qualified personnel. No responsibility is assumed by Schneider Electric for any consequences arising out of the use of this material.

A qualified person is one who has skills and knowledge related to the construction and operation of electrical equipment and its installation, and has received safety training to recognize and avoid the hazards involved.

---

---

# About the Book



## At a Glance

### Document Scope

This guide provides users, installers, and maintenance personnel with technical information needed to operate PowerPact™ B-frame circuit breakers in compliance with the UL®, IEC, CCC, and EAC standards.

### Validity Note

This document applies to PowerPact B-frame circuit breakers.

### Related Documents

Title of Documentation	Reference Number
PowerPact B-Frame 3P/4P Circuit Breakers - Instruction Sheet	EAV91182
PowerPact B-Frame 2P Circuit Breakers - Instruction Sheet	EAV91186
PowerPact B-Frame 1P Circuit Breakers - Instruction Sheet	EAV91187
MN/MX Voltage Releases - Instruction Sheet	EAV91202
OF/SD Indication Contacts - Instruction Sheet	EAV91204
Connection Accessories - Instruction Sheet	NHA56713
Insulation Accessories - Instruction Sheet	EAV91215
Locking Accessories - Instruction Sheet	NHA56710
Terminal Spreaders - Instruction Sheet	NHA65088
Torque Limiting Breakaway Unit - Instruction Sheet	NHA85013
Interphase Barriers - Instruction Sheet	NHA98087
Open Door Shaft Operator - Instruction Sheet	EAV78496
Direct Rotary Handle - Instruction Sheet	EAV91208
Extended Rotary Handle - Instruction Sheet	EAV91209
Side Rotary Handle - Instruction Sheet	EAV91211

You can download these technical publications and other technical information from our website at <http://www.schneider-electric.com/ww/en/download>

### Trademark Notice

All trademarks are owned by Schneider Electric Industries SAS or its affiliated companies.

---



---

# Chapter 1

## PowerPact B-Frame Presentation

---

### What Is in This Chapter?

This chapter contains the following topics:

Topic	Page
Feature Overview	10
Device Overview	11
Thermal-Magnetic Protection for Circuit Breakers	14
Environmental Conditions	15

## Feature Overview

### Feature Overview

PowerPact B-frame devices have the following features:

- Circuit breakers rated from 15 to 125 A
- Available constructions: 1, 2, 3, and 4 poles
- Standard compliance to UL 489, IEC/EN60947-2, CCC, EAC
- Breaking capacities: D, G, J
- Voltage up to 690 Vac compliant with IEC/EN60947-2 (type J only)
- Field-installable electrical accessories
- Optional terminations
- Optional operating mechanisms
- Optional voltage releases (not available on 1-pole)
- Optional auxiliary contacts
- Optional insulation accessories
- Optional locking accessories

### Isolation Characteristics

Circuit breakers offer positive contact indication and are suitable for isolation in accordance with standards IEC/EN60947-1 and IEC/EN60947-2. The **O (OFF)** position of the actuator is sufficient to isolate the circuit breaker.

The following marking on the device identification label indicates that the circuit breaker is capable of isolation:

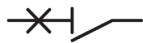

To confirm the isolation capability, the IEC/EN60947-1 and 2 standards require specific shock withstand tests.

In accordance with installation rules, circuit breakers can be locked in the **O (OFF)** position so that work can be carried out with the power off. Circuit breakers can be locked in the **O (OFF)** position only when they are open.

**NOTE:** Locking a circuit breaker in the **O (OFF)** position is sufficient to isolate the circuit breaker.

The choice of locking device depends on the type of actuator:

- Locking circuit breakers with a toggle handle ([see page 29](#))
- Locking circuit breakers with a direct rotary handle ([see page 36](#))
- Locking circuit breakers with an extended rotary handle ([see page 45](#))
- Locking circuit breakers with a side rotary handle ([see page 52](#))

## Device Overview

### Circuit Breaker Description

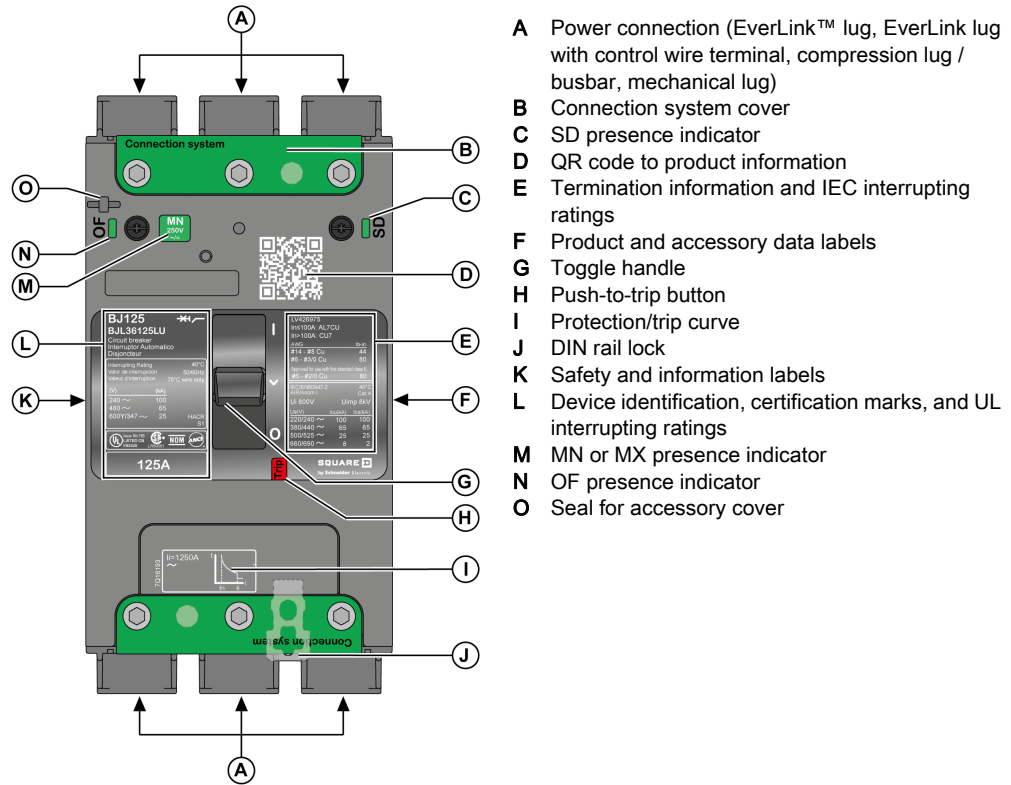

### QR Code

Scan the QR code to get additional information about the circuit breaker from the Schneider Electric web site. To scan the QR code, use a smartphone that is equipped with a camera and installed with a QR code reader.

Accessories

The following accessories are available for the circuit breaker.

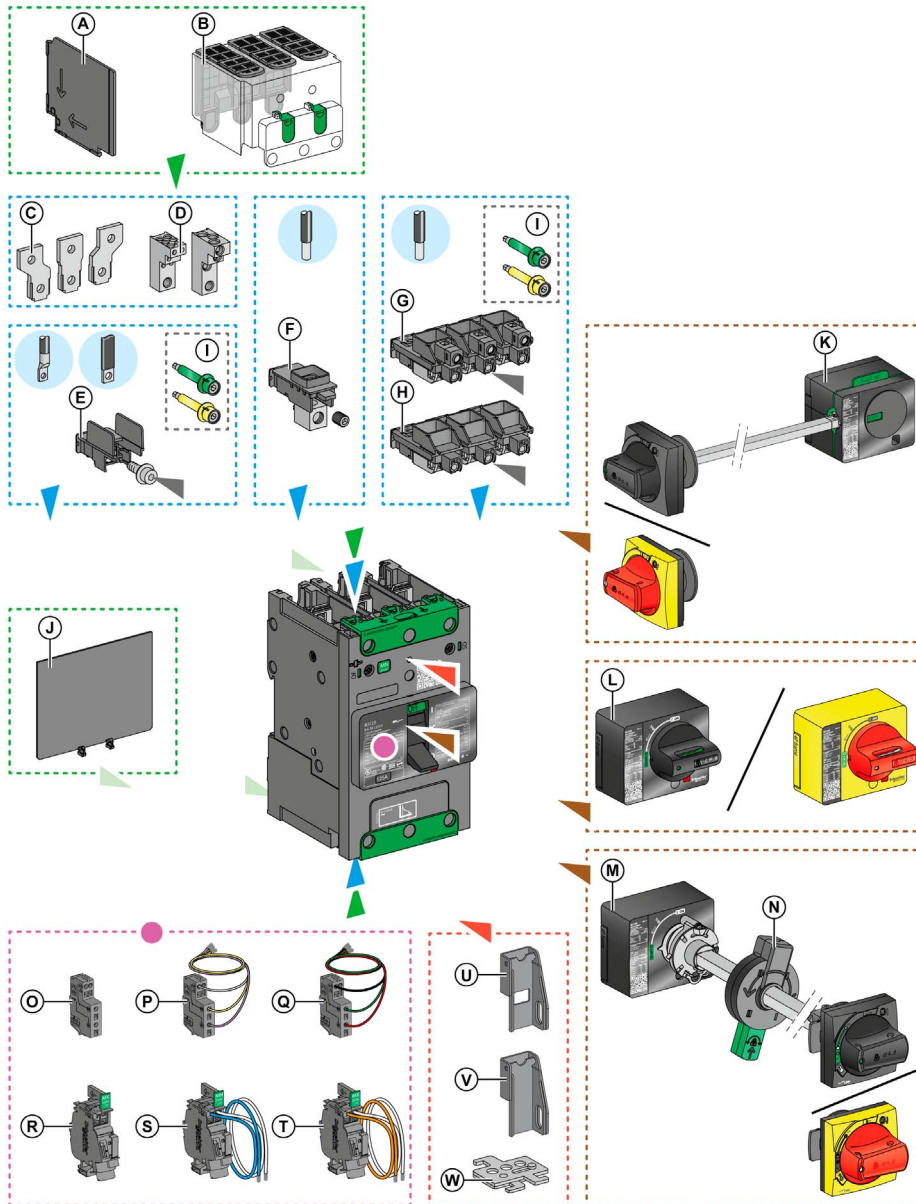

- A Interphase barriers
- B Long terminal shield
- C Terminal spreaders
- D Power distribution connectors (3-hole or 6-hole)
- E Compression lug / busbar connector
- F Aluminum mechanical lug
- G EverLink lug with control wire terminal
- H EverLink lug without control wire terminal
- I Torque limiting breakaway bits
- J Rear insulating screen
- K Side rotary handle (right or left)
- L Direct mounted rotary handle
- M Extended rotary handle
- N Open door shaft operator
- O OF or SD auxiliary contact
- P OF auxiliary contact pre-wired
- Q SD auxiliary contact pre-wired
- R MN or MX voltage release
- S MN undervoltage release pre-wired
- T MX shunt trip pre-wired
- U Fixed toggle handle padlocking device (OFF and ON)
- V Fixed toggle handle padlocking device (OFF only)
- W Removable toggle handle padlocking device (OFF only)

## Sealing Accessories

The following sealing accessories can help prevent unauthorized changes to the circuit breaker.

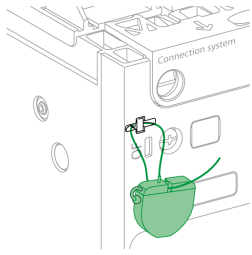
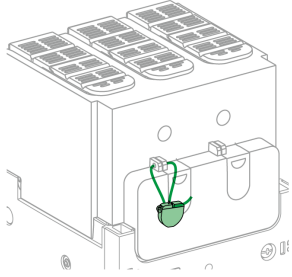
Seal type	Helps to prevent	Seal image
Seal for cover	<ul style="list-style-type: none"><li>● Removal of the front cover</li><li>● Access to the auxiliaries</li></ul>	 A technical drawing of a circuit breaker's front panel. A green seal is shown being applied to a specific opening. The seal has a circular base and a stem that fits into the opening. A label 'Connection system' is visible above the opening.
Seal for long terminal shield	<ul style="list-style-type: none"><li>● Access to the power connections (helps to prevent direct contact)</li><li>● Dismounting of the circuit breaker</li></ul>	 A technical drawing of a circuit breaker's terminal shield. A green seal is shown being applied to a specific opening. The seal has a circular base and a stem that fits into the opening.

## Thermal-Magnetic Protection for Circuit Breakers

### Introduction

Thermal-magnetic protection provides the following features for general-purpose AC applications:

- Thermal protection against overload, with fixed threshold  $I_n$ .
- Instantaneous protection against short circuits, with fixed threshold  $I_i$ .

The following figure shows the trip curve.

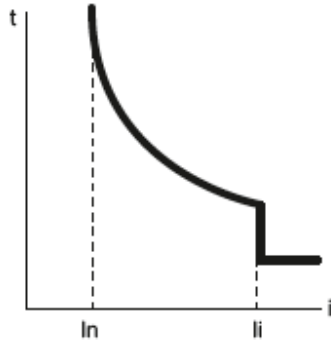

- $I_n$**  Thermal protection pick-up
- $I_i$**  Instantaneous trip point

### Thermal Protection ( $I_n$ )

The thermal protection pick-up value cannot be adjusted. Its value for each frame rating is shown below.

	Frame rating $I_n$ (A)														
	15	20	25	30	35	40	45	50	60	70	80	90	100	110	125
$I_n$ pick-up (A)	15	20	25	30	35	40	45	50	60	70	80	90	100	110	125

### Magnetic Protection ( $I_i$ )

The instantaneous trip point value cannot be adjusted. Its value for each frame rating is shown below.

	Frame rating $I_n$ (A)														
	15	20	25	30	35	40	45	50	60	70	80	90	100	110	125
Hold (A)	400	400	400	400	400	400	400	480	640	640	800	1000	1000	1000	1000
$I_i$ trip (A)	600	600	600	600	600	600	600	720	960	960	1200	1500	1500	1500	1500

## Environmental Conditions

### Temperature

The following temperatures are relevant for circuit breakers:

- **Ambient temperature:** the temperature of the air immediately surrounding the circuit breaker. If the temperature inside the enclosure is above 40 °C (104 °F), devices must be derated.
- **Operating temperature range:** -25 °C to +70 °C (-13 °F to +158 °F).  
**NOTE:** Commissioning is possible down to -35 °C (-31 °F).
- **Storage temperature range:** -50 °C to +85 °C (-58 °F to +185 °F).

The following table gives the standard circuit breaker ampere ratings depending on the frame rating and the operating temperature in the enclosure.

Temperature		Frame rating In (A)														
°C	°F	15 to 125														
40	104	15	20	25	30	35	40	45	50	60	70	80	90	100	110	125
45	113	14	19	24	29	34	39	44	49	58	67	77	87	99	107	121
50	122	14	19	24	28	33	38	42	47	56	64	73	83	96	103	117
55	131	13	18	23	27	32	37	41	45	55	61	70	80	92	99	112
60	140	12	18	22	26	31	36	39	44	53	59	67	76	85	94	109
65	149	12	17	21	25	31	35	37	42	51	55	63	72	80	89	104
70	158	11	16	20	24	30	33	36	40	48	53	59	68	69	76	100

The following table gives the correction factor that applies to tripping time depending on ambient temperature:

Temperature		Frame rating In (A)														
°C	°F	15	20	25	30	35	40	45	50	60	70	80	90	100	110	125
10	50	1.21	1.16	1.15	1.16	1.13	1.14	1.17	1.16	1.16	1.18	1.19	1.19	1.21	1.19	1.17
15	59	1.18	1.13	1.13	1.14	1.11	1.12	1.15	1.14	1.14	1.15	1.15	1.15	1.18	1.16	1.14
20	68	1.15	1.11	1.11	1.11	1.09	1.10	1.12	1.11	1.11	1.13	1.12	1.12	1.15	1.13	1.12
25	77	1.11	1.08	1.08	1.08	1.07	1.07	1.09	1.08	1.08	1.10	1.09	1.10	1.12	1.10	1.09
30	86	1.08	1.06	1.05	1.06	1.05	1.05	1.06	1.06	1.06	1.06	1.06	1.06	1.09	1.07	1.06
35	95	1.04	1.03	1.03	1.03	1.02	1.03	1.03	1.03	1.03	1.03	1.03	1.04	1.05	1.04	1.03
40	104	1	1	1	1	1	1	1	1	1	1	1	1	1	1	1
45	113	0.96	0.97	0.97	0.97	0.98	0.97	0.97	0.97	0.97	0.96	0.96	0.96	0.99	0.98	0.96
50	122	0.92	0.94	0.94	0.94	0.95	0.95	0.94	0.94	0.94	0.91	0.92	0.92	0.96	0.94	0.94
55	131	0.87	0.91	0.91	0.91	0.93	0.92	0.90	0.91	0.91	0.88	0.88	0.89	0.92	0.90	0.90
60	140	0.83	0.88	0.88	0.87	0.90	0.89	0.87	0.87	0.88	0.84	0.83	0.84	0.85	0.85	0.87
65	149	0.78	0.85	0.85	0.84	0.87	0.86	0.83	0.84	0.84	0.79	0.79	0.80	0.80	0.80	0.83
70	158	0.72	0.81	0.82	0.80	0.85	0.83	0.79	0.80	0.81	0.75	0.74	0.75	0.69	0.70	0.80

### Extreme Atmospheric Conditions

Circuit breakers are designed to operate in industrial atmospheres as defined in standard IEC/EN60947-2 for the highest level of pollution (level 3).

Circuit breakers are tested for extreme storage conditions and are compliant with the following standards:

Standard	Title
IEC60068-2-2	Dry heat, severity level +85 °C (+185 °F)
IEC60068-2-1	Dry cold, severity level -50 °C (-58 °F)
IEC60068-2-30	Damp heat: <ul style="list-style-type: none"> <li>• Temperature +55 °C (+131 °F)</li> <li>• Relative humidity 95%</li> </ul>
IEC60068-2-52	Salt mist, severity 2

To maximize lifetime, install circuit breakers in properly ventilated equipment with minimal dust.

### Vibration

Circuit breakers are designed to withstand vibration. They meet the IEC60068-2-6 standard for vibration:

- 2 Hz to 25 Hz with an amplitude of +/- 1.6 mm (+/- 0.06 in.)
- 25 Hz to 100 Hz at a constant acceleration of +/- 4 g

Conformity tests are carried out in accordance with the IEC60068-2-6 standard, at the levels of severity required by the merchant shipping regulatory bodies (mainly IACS, Veritas, and Lloyd's).

Excessive vibration can cause tripping, breaks in connections, or damage to mechanical parts.

### Electromagnetic Disturbance

Circuit breakers resist electromagnetic disturbance. They comply with the requirements of the electromagnetic compatibility (EMC) standard IEC60947-2.

### Altitude

Circuit breakers are designed to operate within specification at altitudes up to 2,000 m (6,600 ft.). Above 2,000 m (6,600 ft), the following derating is required:

Characteristic		Altitude (m/ft)			
		2,000 m (6,600 ft)	3,000 m (9,800 ft)	4,000 m (13,000 ft)	5,000 m (16,500 ft)
Impulse withstand voltage	Uimp	8 kV	7.1 kV	6.4 kV	5.6 kV
Insulation voltage	Ui	800 V	710 V	635 V	560 V
Maximum operational voltage	Ue	690 V	690 V	635 V	560 V
Average current capacity (A) at 40 °C (104 °F)	In x	1	0.98	0.96	0.94



---

# Chapter 2

## PowerPact B-Frame Insulation Requirements and Accessories

---

### What Is in This Chapter?

This chapter contains the following topics:

Topic	Page
Insulation Accessories	18
Clearance Requirements for PowerPact B-Frame Circuit Breakers	19

## Insulation Accessories

### Overview of Insulation Accessories

The following insulation accessories can be used with the range of PowerPact B-frame circuit breakers. For more information, see the *PowerPact B-Frame Catalog*.

Insulation accessory	EverLink power connectors				All other power connectors			
	1P	2P	3P	4P	1P	2P	3P	4P
Long terminal shield	—	—	—	—	—	✓	✓	✓
Interphase barriers	—	—	—	—	—	✓	✓	✓
Rear insulation screen	—	✓	✓	✓	—	✓	✓	✓

### Presentation of Insulation Accessories

The following insulation accessories can be installed on-site.

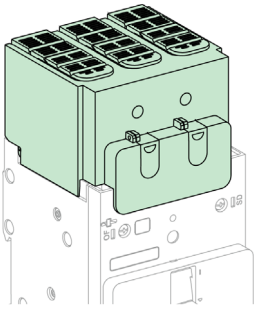
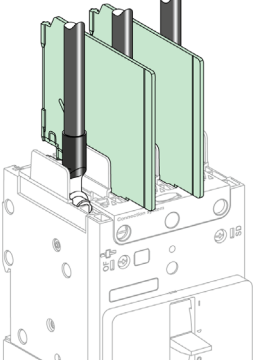
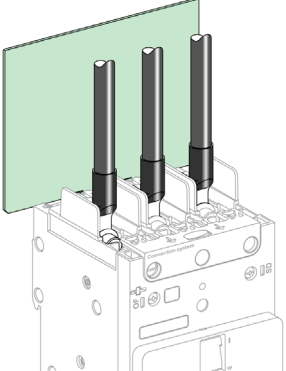
Insulation accessory	Benefit	Accessory image
Long terminal shield	IP40 protection	
Flexible interphase barriers	Improve insulation between power connections	
Rear insulation screen	Improve insulation between backplate and power connections, especially with spreaders	

## Clearance Requirements for PowerPact B-Frame Circuit Breakers

### Introduction

When installing PowerPact B-frame circuit breakers in equipment, minimum distances (safety clearance) must be maintained between the device and panels, bars, or any metal installed nearby.

Minimum distances depend on the ultimate breaking capacity, and are defined by tests carried out in accordance with the IEC/EN60947-2 standard.

If IEC installation conformity is not checked by type tests, you must also:

- Use insulated bars for circuit breaker connections.
- Block off the busbars by using rear insulation screens.

### Equipment Installation Requirements

 **DANGER**

**HAZARD OF ELECTRIC SHOCK, EXPLOSION, OR ARC FLASH**

- Apply appropriate personal protective equipment (PPE) and follow safe electrical work practices. See NFPA 70E, CSA Z462, NOM-029-STPS, or local equivalent.
- This equipment must only be installed and serviced by qualified electrical personnel.
- Turn off all power supplying this equipment before working on or inside equipment.
- Always use a properly rated voltage sensing device to confirm that power is off.
- Replace all devices, doors, and covers before turning on power to this equipment.
- Beware of potential hazards, and carefully inspect the work area for tools and objects that may have been left inside the equipment.

**Failure to follow these instructions will result in death or serious injury.**

Follow these guidelines when installing circuit breakers in equipment:

- Respect minimum distances.
- Perform dielectric strength tests, thermal calculations, and temperature rise tests as required by the configuration of the installation.
- Respect the limits defined in the derating tables, depending on the ambient temperature (ratings are based on IEC/EN60947-2 standard).

 **DANGER**

**HAZARD OF ELECTRIC SHOCK, EXPLOSION, OR ARC FLASH**

Install circuit breaker so minimum clearance distance to grounded metal is maintained.

**Failure to follow these instructions will result in death or serious injury.**

### Minimum Distances for Side-by-Side Installation

There is no minimum distance required between circuit breakers installed side-by-side.

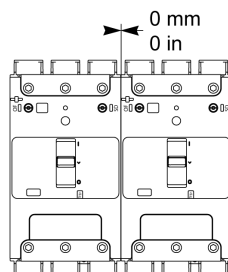

**Minimum UL Enclosure Volume**

The minimum enclosure dimensions (or equivalent calculated volume) required for the whole range of circuit breakers are shown below.

1P front view	2P front view	3P/4P front view	Side view

**Minimum Clearance Without Insulation Accessories**

The minimum clearance distances required around circuit breakers without insulation accessories are shown below.

1P	2P	3P/4P
<p>With painted sheet metal:</p> <ul style="list-style-type: none"> <li>● A1: 30 mm (1.18 in.)</li> <li>● A2: 5 mm (0.19 in.)</li> <li>● B: 0 mm (0 in.)</li> </ul> <p>With bare sheet metal:</p> <ul style="list-style-type: none"> <li>● A1: 40 mm (1.57 in.)</li> <li>● A2: 5 mm (0.19 in.)</li> <li>● B: 5 mm (0.19 in.)</li> </ul>	<p>With painted sheet metal:</p> <ul style="list-style-type: none"> <li>● A1: 30 mm (1.18 in.)</li> <li>● A2: 5 mm (0.19 in.)</li> <li>● B: 0 mm (0 in.)</li> </ul> <p>With bare sheet metal:</p> <ul style="list-style-type: none"> <li>● A1: 40 mm (1.57 in.)</li> <li>● A2: 5 mm (0.19 in.)</li> <li>● B: 5 mm (0.19 in.)</li> </ul>	<p>With painted sheet metal:</p> <ul style="list-style-type: none"> <li>● A1: 30 mm (1.18 in.)</li> <li>● A2: 5 mm (0.19 in.)</li> <li>● B: 0 mm (0 in.)</li> </ul> <p>With bare sheet metal:</p> <ul style="list-style-type: none"> <li>● A1: 40 mm (1.57 in.)</li> <li>● A2: 5 mm (0.19 in.)</li> <li>● B: 5 mm (0.19 in.)</li> </ul>

### Minimum Clearance with Interphase Barriers

The minimum clearance distances required around circuit breakers equipped with interphase barriers are shown below.

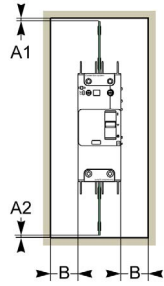
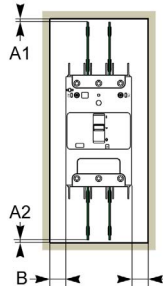
2P	3P/4P
	
<p>With painted sheet metal:</p> <ul style="list-style-type: none"> <li>● A1: 0 mm (0 in.)</li> <li>● A2: 0 mm (0 in.)</li> <li>● B: 0 mm (0 in.)</li> </ul> <p>With bare sheet metal:</p> <ul style="list-style-type: none"> <li>● A1: 0 mm (0 in.)</li> <li>● A2: 0 mm (0 in.)</li> <li>● B: 5 mm (0.19 in.)</li> </ul>	<p>With painted sheet metal:</p> <ul style="list-style-type: none"> <li>● A1: 0 mm (0 in.)</li> <li>● A2: 0 mm (0 in.)</li> <li>● B: 0 mm (0 in.)</li> </ul> <p>With bare sheet metal:</p> <ul style="list-style-type: none"> <li>● A1: 0 mm (0 in.)</li> <li>● A2: 0 mm (0 in.)</li> <li>● B: 5 mm (0.19 in.)</li> </ul>

### Minimum Clearance with Long Terminal Shields

The minimum clearance distances required around circuit breakers equipped with long terminal shields are shown below.

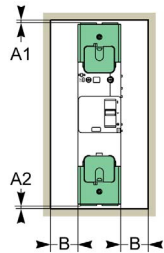
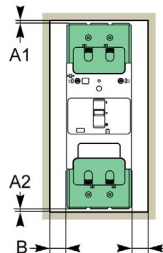
2P	3P/4P
	
<p>With painted sheet metal:</p> <ul style="list-style-type: none"> <li>● A1: 0 mm (0 in.)</li> <li>● A2: 0 mm (0 in.)</li> <li>● B: 0 mm (0 in.)</li> </ul> <p>With bare sheet metal:</p> <ul style="list-style-type: none"> <li>● A1: 0 mm (0 in.)</li> <li>● A2: 0 mm (0 in.)</li> <li>● B: 5 mm (0.19 in.)</li> </ul>	<p>With painted sheet metal:</p> <ul style="list-style-type: none"> <li>● A1: 0 mm (0 in.)</li> <li>● A2: 0 mm (0 in.)</li> <li>● B: 0 mm (0 in.)</li> </ul> <p>With bare sheet metal:</p> <ul style="list-style-type: none"> <li>● A1: 0 mm (0 in.)</li> <li>● A2: 0 mm (0 in.)</li> <li>● B: 5 mm (0.19 in.)</li> </ul>

**Minimum Clearance with Live Parts**

The minimum clearance distances required around circuit breakers using busbars are shown below.

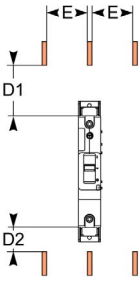
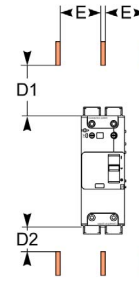
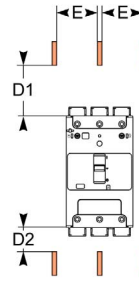
		1P	2P	3P/4P
				
$E \leq 60 \text{ mm}$ (2.36 in.)	$U \leq 690 \text{ V}$	<ul style="list-style-type: none"> <li>● D1: 200 mm (7.87 in.)</li> <li>● D2: 100 mm (3.94 in.)</li> </ul>	<ul style="list-style-type: none"> <li>● D1: 200 mm (7.87 in.)</li> <li>● D2: 100 mm (3.94 in.)</li> </ul>	<ul style="list-style-type: none"> <li>● D1: 200 mm (7.87 in.)</li> <li>● D2: 100 mm (3.94 in.)</li> </ul>
$E > 60 \text{ mm}$ (2.36 in.)	$U \leq 690 \text{ V}$	<ul style="list-style-type: none"> <li>● D1: 120 mm (4.72 in.)</li> <li>● D2: 60 mm (2.36 in.)</li> </ul>	<ul style="list-style-type: none"> <li>● D1: 120 mm (4.72 in.)</li> <li>● D2: 60 mm (2.36 in.)</li> </ul>	<ul style="list-style-type: none"> <li>● D1: 120 mm (4.72 in.)</li> <li>● D2: 60 mm (2.36 in.)</li> </ul>

**Minimum Clearance Between Backplate and Uninsulated Power Connections**

For all types of PowerPact B-frame circuit breakers that use uninsulated power connections (for example, busbars, spreaders, or uninsulated crimped lugs), the minimum clearance distance with the enclosure backplate is shown below.

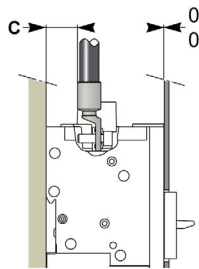

A rear insulation screen or long terminal shield is required if the distance C is less than 12.7 mm (0.5 in) for all circuit breakers.

---

# Chapter 3

## Operating the PowerPact B-Frame

---

### What Is in This Chapter?

This chapter contains the following sections:

Section	Topic	Page
3.1	Operating a Circuit Breaker with a Toggle Handle	24
3.2	Operating a Circuit Breaker with a Direct Rotary Handle	30
3.3	Operating a Circuit Breaker with a Front Extended Rotary Handle	39
3.4	Operating a Circuit Breaker with a Side Rotary Handle	48

## Section 3.1

### Operating a Circuit Breaker with a Toggle Handle

---

#### What Is in This Section?

This section contains the following topics:

Topic	Page
Description	25
Opening, Closing, Resetting, and Testing the Circuit Breaker	27
Locking the Circuit Breaker	29



## Description

### Front Face

The following figure shows the controls and indicators for a 3-pole circuit breaker with a toggle handle. The location of controls and indicators may differ for the other types of circuit breakers. Information about the other parts of the front face is available in the general description (*see page 11*).

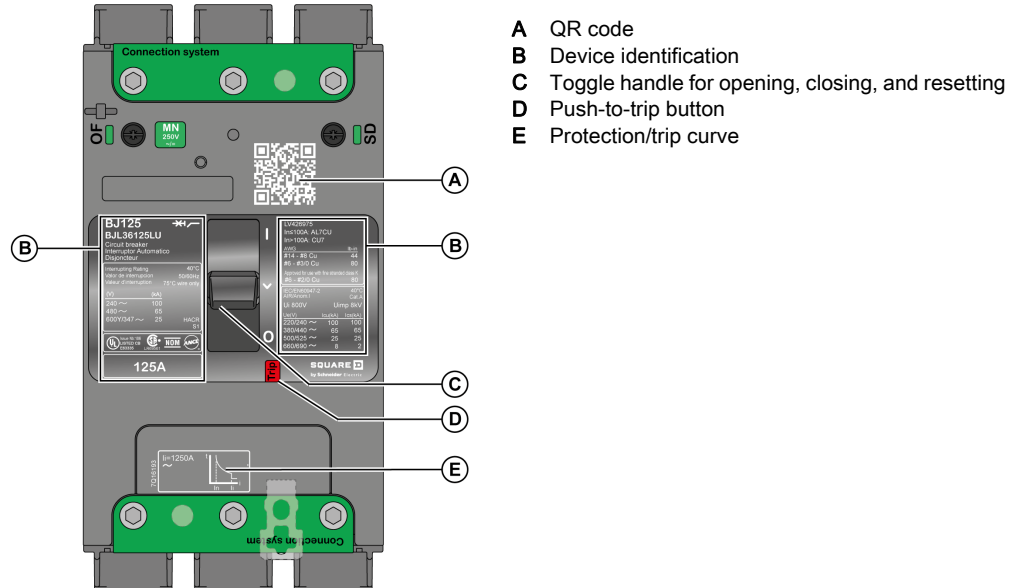

- A QR code
- B Device identification
- C Toggle handle for opening, closing, and resetting
- D Push-to-trip button
- E Protection/trip curve

### Device Identification

The following figure shows an example of the device identification for a circuit breaker with a toggle handle. Your circuit breaker may have different values.

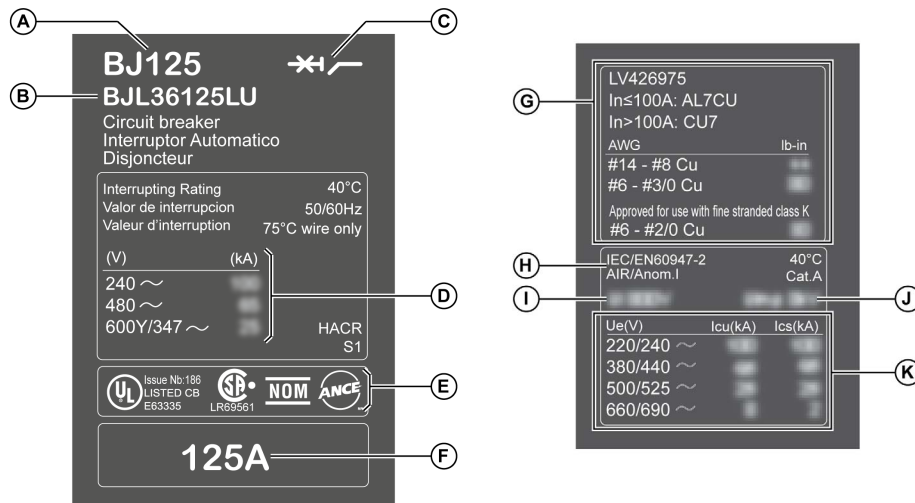

- A Circuit breaker type
- B Commercial reference
- C Circuit breaker symbol
- D UL interrupting rating
- E Certification marks
- F Frame rating
- G Termination characteristics
- H Reference standard
- I U<sub>i</sub>: rated insulation voltage
- J U<sub>imp</sub>: rated impulse withstand voltage
- K IEC interrupting ratings, according to operating voltage U<sub>e</sub>:  
I<sub>cu</sub>: Ultimate breaking capacity  
I<sub>cs</sub>: Service breaking capacity

### QR Code

Scan the QR code to get additional information about the circuit breaker from the Schneider Electric website. To scan the QR code, use a smartphone that is equipped with a camera and installed with a QR code reader.

## Opening, Closing, Resetting, and Testing the Circuit Breaker

### Opening and Closing with the Toggle Handle

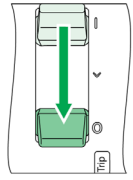
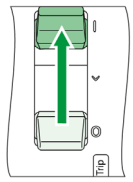
Task	Action	
Open the circuit breaker	Push the toggle handle from the <b>I (ON)</b> position to the <b>O (OFF)</b> position.	
Close the circuit breaker	Push the toggle handle from the <b>O (OFF)</b> position to the <b>I (ON)</b> position	

### Resetting with the Toggle Handle After a Trip

When the circuit breaker trips, the toggle handle moves from the **I (ON)** position to the **▼ (Trip)** position.

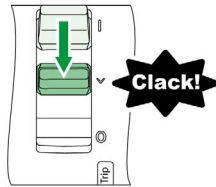

## **⚠ CAUTION**

### HAZARD OF CLOSING ON ELECTRICAL FAULT

Do not close the circuit breaker without first inspecting and, if necessary, repairing the downstream electrical equipment.

**Failure to follow these instructions can result in injury or equipment damage.**

The fact that a circuit breaker has tripped does not fix the cause of the fault detected on the downstream electrical equipment.

Follow these steps to reset the circuit breaker after a trip caused by an electrical fault.

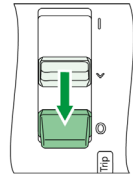
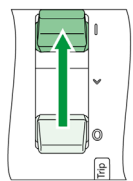
Step	Action		Position
1	Push the toggle handle from the <b>▼ (Trip)</b> position to the <b>O (OFF)</b> position. The circuit breaker is open.		<b>O (OFF)</b>
2	Take precautions to protect yourself ( <i>see page 64</i> ).	–	<b>O (OFF)</b>
3	Look for the cause of the detected fault ( <i>see page 64</i> ).	–	<b>O (OFF)</b>
4	Clean and test the downstream equipment and the circuit breaker ( <i>see page 64</i> ).	–	<b>O (OFF)</b>
5	Push the toggle handle from the <b>O (OFF)</b> position to the <b>I (ON)</b> position. The circuit breaker is closed.		<b>I (ON)</b>

Testing the Trip Mechanism

**⚠ CAUTION**

**HAZARD OF NUISANCE TRIPPING**  
 Circuit breaker tests must only be done by qualified electrical personnel.  
**Failure to follow these instructions can result in injury or equipment damage.**

When testing the trip mechanism, take precautions against:

- Disrupting operations
- Activating inappropriate alarms
- Triggering unwanted actions

For example, tripping the circuit breaker with the push-to-trip button can lead to inappropriate fault indications or corrective actions (such as switching to an alternate power source).

Follow these steps to test the trip mechanism.

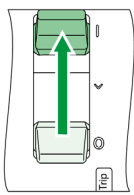
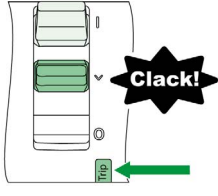
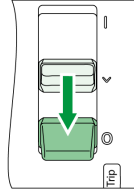
Step	Action		Position
1	Push the toggle handle from to the <b>O (OFF)</b> position to the <b>I (ON)</b> position. The circuit breaker is closed.		<b>I (ON)</b>
2	Press the push-to-trip button. The handle moves from the <b>I (ON)</b> position to the <b>∨ (Trip)</b> position. The circuit breaker is tripped.		<b>∨ (Trip)</b>
3	Push the toggle handle from the <b>∨ (Trip)</b> position to the <b>O (OFF)</b> position. The circuit breaker is reset.		<b>O (OFF)</b>

## Locking the Circuit Breaker

### Locking Options for the Toggle Handle

**⚡ ⚠ DANGER**

**HAZARD OF ELECTRIC SHOCK, EXPLOSION, OR ARC FLASH**

When the circuit breaker handle is locked in the **O (OFF)** position, always use a properly rated voltage sensing device to confirm power is off before working on equipment.

**Failure to follow these instructions will result in death or serious injury.**

**NOTE:** Locking the handle in the **I (ON)** position does not disable the circuit breaker. If an electrical fault is detected, the circuit breaker trips. When the handle is unlocked, it moves to the tripped position. To return the circuit breaker to service, reset the circuit breaker (*see page 27*).

The following accessories can be used to lock the toggle handle:

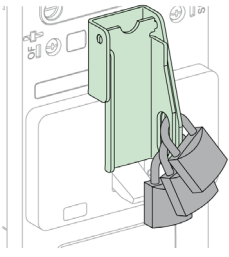
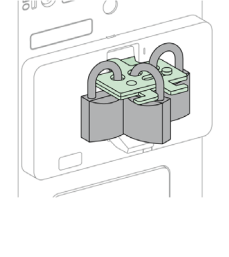
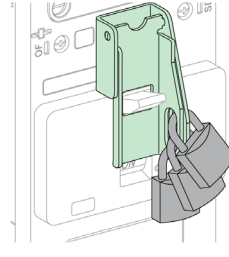
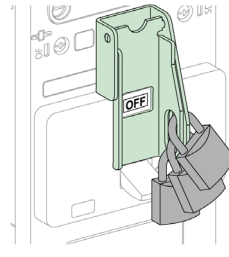
Locked position	Lock type	Lock characteristics	Lock image
O (OFF)	Fixed: the device cannot be removed from the case.	Up to 3 padlocks (not supplied) Diameter 4–8 mm (3/16–5/16 in.)	
O (OFF)	Removable: the device can be removed from the case.	Up to 3 padlocks (not supplied) Diameter 4–8 mm (3/16–5/16 in.)	
I (ON) or O (OFF)	Fixed: the device cannot be removed from the case.	Up to 3 padlocks (not supplied) Diameter 4–8 mm (3/16–5/16 in.)	Locked in the <b>I (ON)</b> position. 
			Locked in the <b>O (OFF)</b> position. 

## Section 3.2

### Operating a Circuit Breaker with a Direct Rotary Handle

---

#### What Is in This Section?

This section contains the following topics:

Topic	Page
Description	31
Opening, Closing, Resetting, and Testing the Circuit Breaker	33
Locking the Circuit Breaker	36

## Description

### Front Face

The following figure shows the controls and indicators for a 3-pole circuit breaker with a direct rotary handle. The location of controls and indicators may differ for the other types of circuit breakers. Information about the other parts of the front face is available in the general description (*see page 11*).

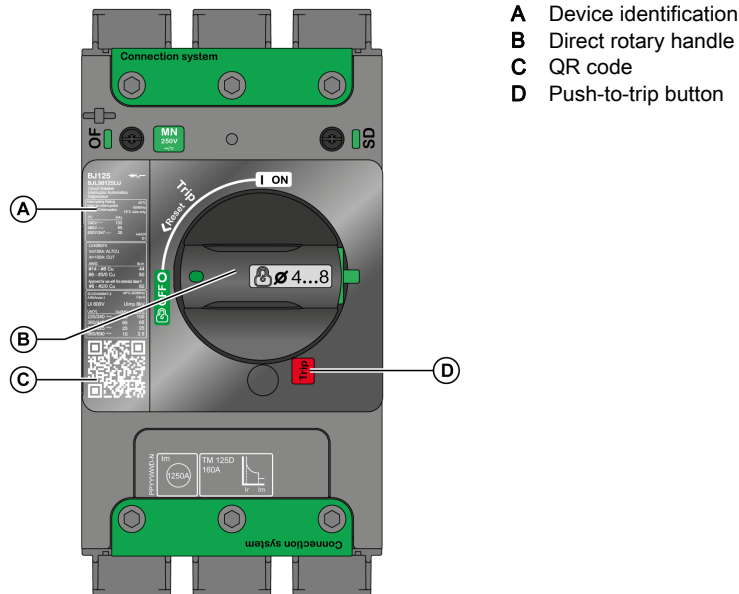

- A Device identification
- B Direct rotary handle
- C QR code
- D Push-to-trip button

### Device Identification

The following figure shows an example of the device identification for a circuit breaker with a direct rotary handle. Your circuit breaker may have different values.

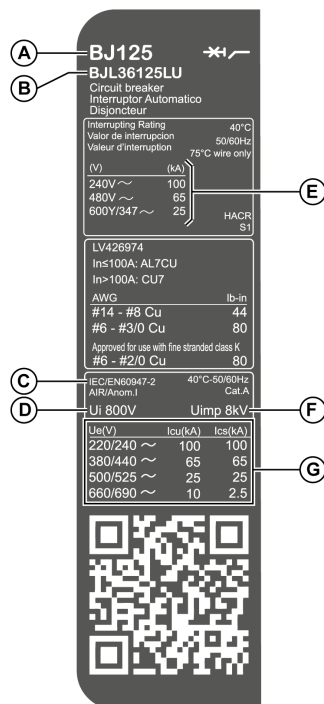

- A Circuit breaker type
- B Commercial reference
- C IEC reference standard
- D  $U_i$  rated insulation voltage
- E  $U_{imp}$ : rated impulse withstand voltage
- F Interrupting ratings, according to operating voltage  $U_e$ :
- G IEC interrupting ratings, according to operating voltage  $U_e$ :  
  - $I_{cu}$ : Ultimate breaking capacity
  - $I_{cs}$ : Service breaking capacity

### QR Code

Scan the QR code to get additional information about the circuit breaker from the Schneider Electric website. To scan the QR code, use a smartphone that is equipped with a camera and installed with a QR code reader.



## Opening, Closing, Resetting, and Testing the Circuit Breaker

### Opening and Closing with the Direct Rotary Handle

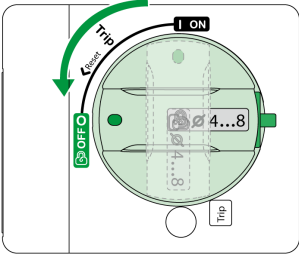
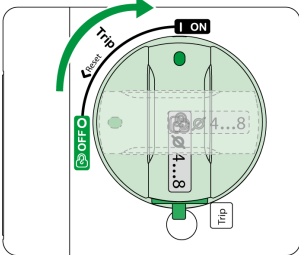
Task	Action	
Open the circuit breaker	Turn the rotary handle from the <b>I (ON)</b> position to the <b>O (OFF)</b> position.	
Close the circuit breaker	Turn the rotary handle from the <b>O (OFF)</b> position to the <b>I (ON)</b> position.	

**Resetting with the Direct Rotary Handle After a Trip**

When the circuit breaker trips, the rotary handle moves from the **I (ON)** position to the **Trip** position.

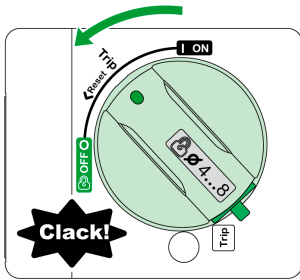

**⚠ CAUTION**

**HAZARD OF CLOSING ON ELECTRICAL FAULT**

Do not close the circuit breaker without first inspecting and, if necessary, repairing the downstream electrical equipment.

**Failure to follow these instructions can result in injury or equipment damage.**

The fact that a circuit breaker has tripped does not fix the cause of the fault detected on the downstream electrical equipment.

Follow these steps to reset the circuit breaker after a trip caused by an electrical fault.

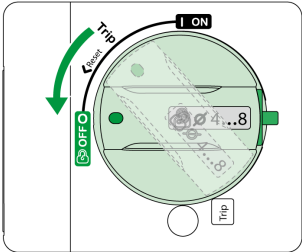
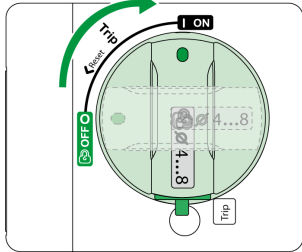
Step	Action		Position
1	Turn the rotary handle from the <b>Trip</b> position to the <b>O (OFF)</b> position. The circuit breaker resets and is open.		<b>O (OFF)</b>
2	Take precautions to protect yourself <i>(see page 64)</i> .	–	<b>O (OFF)</b>
3	Look for the cause of the detected fault <i>(see page 64)</i> .	–	<b>O (OFF)</b>
4	Clean and test the downstream equipment and the circuit breaker <i>(see page 64)</i> .	–	<b>O (OFF)</b>
5	Turn the rotary handle from the <b>O (OFF)</b> position to the <b>I (ON)</b> position. The circuit breaker is closed.		<b>I (ON)</b>

Testing the Trip Mechanism

**⚠ CAUTION**

**HAZARD OF NUISANCE TRIPPING**

Circuit breaker tests must only be done by qualified electrical personnel.

**Failure to follow these instructions can result in injury or equipment damage.**

When testing the trip mechanism, take precautions against:

- Disrupting operations
- Activating inappropriate alarms
- Triggering unwanted actions

For example, tripping the circuit breaker with the push-to-trip button can lead to inappropriate fault indications or corrective actions (such as switching to an alternate power source).

Follow these steps to test the trip mechanism.

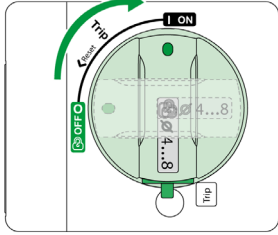
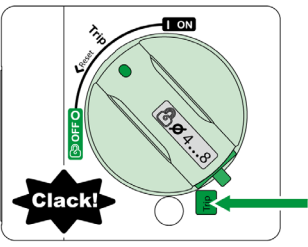
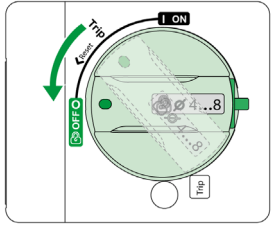
Step	Action		Position
1	Turn the rotary handle from the <b>O (OFF)</b> position to the <b>I (ON)</b> position. The circuit breaker is closed.		<b>I (ON)</b>
2	Press the Trip button. The handle moves from the <b>I (ON)</b> position to the <b>Trip</b> position. The circuit breaker is tripped.		<b>Trip</b>
3	Turn the rotary handle from the Trip position to the <b>O (OFF)</b> position. The circuit breaker is reset.		<b>O (OFF)</b>

## Locking the Circuit Breaker

### Locking Options with the Direct Rotary Handle

**⚡ ⚠ DANGER**

**HAZARD OF ELECTRIC SHOCK, EXPLOSION, OR ARC FLASH**

When the circuit breaker handle is locked in the **O (OFF)** position, always use a properly rated voltage sensing device to confirm power is off before working on equipment.

**Failure to follow these instructions will result in death or serious injury.**

The direct rotary handle offers the following locking options:

- Prevent the door from being opened if the door interlock was activated at installation time
- Prevent the rotary handle from being operated

The handle can be locked in the **O (OFF)** or **I (ON)** position.

No setup is required to lock the handle in the **O (OFF)** position.

Before the handle can be locked in the **I (ON)** position, the rotary handle block must be dismantled and the physical setup of the handle must be changed. This is usually done at installation. For information about how to set up the handle to be locked in the **I (ON)** position, see the relevant instruction sheet ([see page 7](#)).

**NOTE:** Locking the rotary handle in the **I (ON)** position does not disable the circuit breaker. If an electrical fault is detected, the circuit breaker still trips. When the rotary handle is unlocked, it moves to the **Trip** position.

Lock position	Lock type	Lock characteristics	Lock image
O (OFF)	Standard padlocking	Up to 3 padlocks (not supplied) Diameter: 4–8 mm (3/16–5/16 in.)	
I (ON) or O (OFF)	Padlocking after modification of the rotary handle during installation	Up to 3 padlocks (not supplied) Diameter: 4–8 mm (3/16–5/16 in.)	 

Inserting Padlocks in the Handle

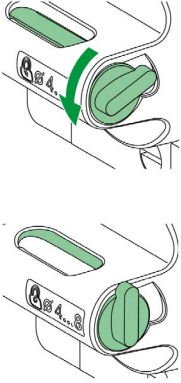
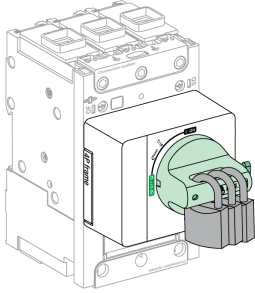
Step	Action	Comment
1	With the handle in the <b>O (OFF)</b> or <b>I (ON)</b> position, turn the knob as illustrated until the slot in the handle opens.	
2	Insert the padlocks in the slot.	

Overriding the Door Interlock

**⚠ ⚠ DANGER**

**HAZARD OF ELECTRIC SHOCK, EXPLOSION, OR ARC FLASH**

Overriding the door interlock must only be done by qualified electrical personnel.

**Failure to follow these instructions will result in death or serious injury.**

If it was activated at the time of installation, the interlock between the door and the circuit breaker allows you to open the door only when the circuit breaker is open and the rotary handle is in the **O (OFF)** position. When the rotary handle is in the **I (ON)** position or the **Trip** position, the door interlock prevents you from opening the door. To open the door, you must turn the handle to the **O (OFF)** position.

Under exceptional circumstances, qualified electrical personnel can follow these steps to open the door while the rotary handle is in the **I (ON)** position or the **Trip** position:

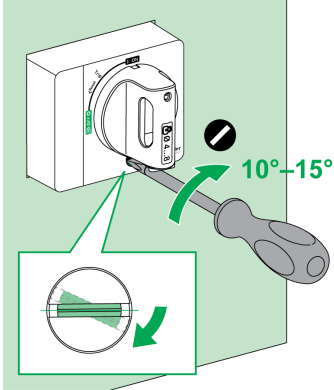
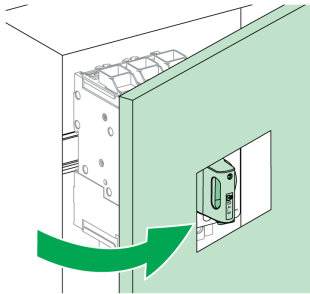
Step	Action	
1	Using a screwdriver, turn the locking screw clockwise by 10-15 degrees and then hold the screwdriver in place.	
2	Still holding the screwdriver in place, open the door and then release the locking screw.	

To close the door, use a screwdriver to turn the locking screw clockwise by 10-15 degrees. Holding the screwdriver in place, close the door and then release the locking screw.

---

## Section 3.3

### Operating a Circuit Breaker with a Front Extended Rotary Handle

---

#### What Is in This Section?

This section contains the following topics:

Topic	Page
Description	40
Opening, Closing, Resetting, and Testing the Circuit Breaker	41
Locking the Circuit Breaker	45

## Description

### Front Face

The controls, indicators, and locking mechanism are located on the following parts of the circuit breaker:

- The operating control is on the enclosure door.
- The operation indicators are on the circuit breaker and on the door plate.
- The locking mechanism is on the circuit breaker (door open) or on the door plate (door closed).

To operate the circuit breaker when the door is open, use an open door shaft operator, available as an accessory.

The following figures show the controls and indicators for a circuit breaker with a front extended rotary handle. Information about the other parts of the front face is available in the general description (*see page 11*).

Cabinet door open

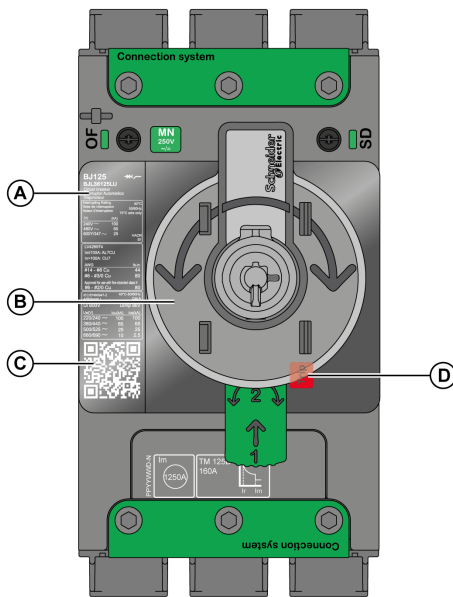

Cabinet door closed

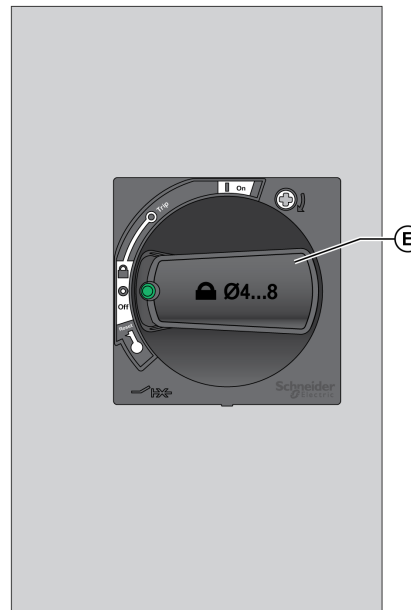

- A** Device identification
- B** Open door shaft operator
- C** QR code
- D** Push-to-trip button

- E** Door operator

### Device Identification

Information about the circuit breaker is given on the device identification label (*see page 31*).

### QR Code

Scan the QR code to get additional information about the circuit breaker from the Schneider Electric website. To scan the QR code, use a smartphone that is equipped with a camera and installed with a QR code reader.



## Opening, Closing, Resetting, and Testing the Circuit Breaker

### Opening and Closing with the Front Extended Rotary Handle

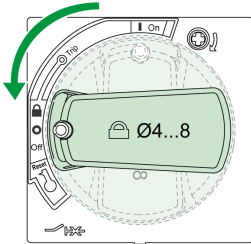
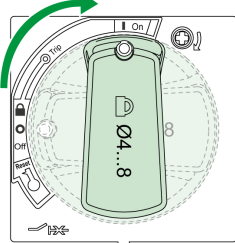
Task	Action	
Open the circuit breaker	Turn the rotary handle from the <b>I (ON)</b> position to the <b>O (OFF)</b> position.	
Close the circuit breaker	Turn the rotary handle from the <b>O (OFF)</b> position to the <b>I (ON)</b> position.	

### Resetting the Front Extended Rotary Handle After a Trip

When the circuit breaker trips, the rotary handle moves from the **I (ON)** position to the **Trip** position.

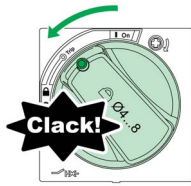

**⚠ CAUTION**

**HAZARD OF CLOSING ON ELECTRICAL FAULT**

Do not close the circuit breaker without first inspecting and, if necessary, repairing the downstream electrical equipment.

**Failure to follow these instructions can result in injury or equipment damage.**

The fact that a circuit breaker has tripped does not fix the cause of the fault detected on the downstream electrical equipment.

Follow these steps to reset the circuit breaker after a trip caused by an electrical fault.

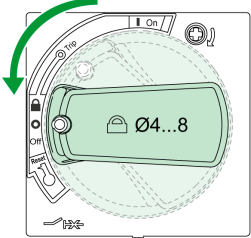
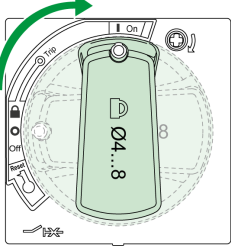
Step	Action		Position
1	Turn the handle from the <b>Trip</b> position to the <b>O (OFF)</b> position. The circuit breaker is open.		<b>O (OFF)</b>
2	Take precautions to protect yourself ( <i>see page 64</i> ).	–	<b>O (OFF)</b>
3	Look for the cause of the detected fault ( <i>see page 64</i> ).	–	<b>O (OFF)</b>
4	Clean and test the downstream equipment and the circuit breaker ( <i>see page 64</i> ).	–	<b>O (OFF)</b>
5	Turn the handle from the <b>O (OFF)</b> position to the <b>I (ON)</b> position. The circuit breaker is closed.		<b>I (ON)</b>

Testing the Trip Mechanism

**CAUTION**

**HAZARD OF NUISANCE TRIPPING**

Circuit breaker tests must only be done by qualified electrical personnel.

**Failure to follow these instructions can result in injury or equipment damage.**

When testing the trip mechanism take precautions against:

- Disrupting operations
- Activating inappropriate alarms
- Triggering unwanted actions

For example, tripping the circuit breaker with the push-to-trip button can lead to inappropriate fault indications or corrective actions (such as switching to an alternate power source).

There is no push-to-trip button on the door of a circuit breaker with a front extended rotary handle. To check the trip mechanism, the door must first be opened.

Follow these steps to test the trip mechanism.

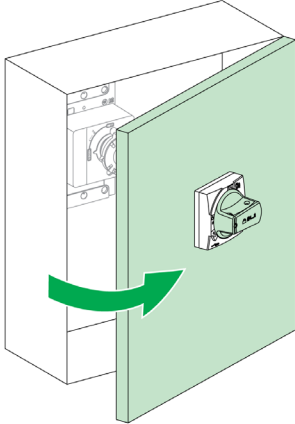
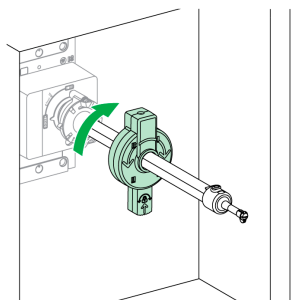
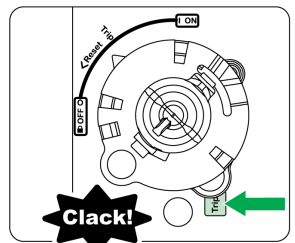
Step	Action		Position
1	With the circuit breaker in the <b>O (OFF)</b> position, open the door.		<b>O (OFF)</b>
2	Turn the circuit breaker from the <b>O (OFF)</b> position to the <b>I (ON)</b> position, using one of the following tools: <ul style="list-style-type: none"> <li>• An open door shaft operator (LV426937).</li> <li>• A flat wrench, taking care not to damage the extension shaft or its surface treatment. The extension shaft is a hollow rectangular tube, 15 x 10 mm (0.59 x 0.39 in.).</li> </ul> The circuit breaker is ready for the test.		<b>I (ON)</b>
3	Press the push-to-trip button. The circuit breaker trips.		<b>Trip</b>

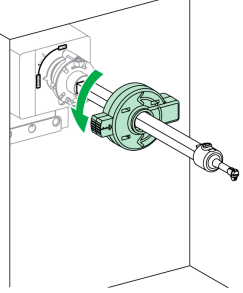
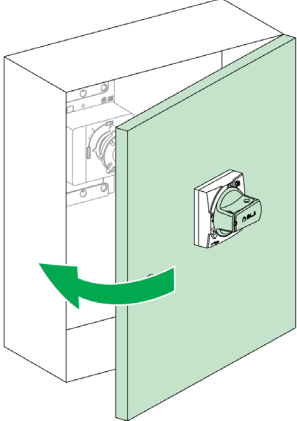
Step	Action		Position
4	Turn the circuit breaker from the Trip position to the <b>O (OFF)</b> position. The circuit breaker is open.		<b>O (OFF)</b>
5	Close the door.		-

## Locking the Circuit Breaker

### Locking Options for the Front Extended Rotary Handle

**⚡ ⚠ DANGER**

**HAZARD OF ELECTRIC SHOCK, EXPLOSION, OR ARC FLASH**

When the circuit breaker handle is locked in the **O (OFF)** position, always use a properly rated voltage sensing device to confirm power is off before working on equipment.

**Failure to follow these instructions will result in death or serious injury.**

The extended rotary handle offers the following locking options:

- Prevent the door from being opened
- Prevent the rotary handle from being operated
- Prevent the circuit breaker itself from being operated

The handle can be locked in the **O (OFF)** position or, in the case of the black door operator, in the **I (ON)** position.

No setup is required to lock the handle in the **O (OFF)** position.

Before the handle can be locked in the **I (ON)** position, the door operator must be dismantled and the physical setup of the handle must be changed. This is usually done at installation. For information about how to set up the handle to be locked in the **I (ON)** position, see the relevant instruction sheet ([see page 7](#)).

**NOTE:** Locking the rotary handle in the **I (ON)** position does not disable the circuit breaker. If there is a fault detection, the circuit breaker still trips. When the rotary handle is unlocked, it moves to the **Trip** position.

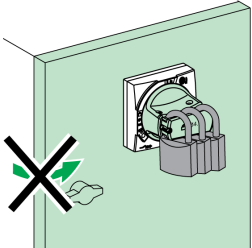
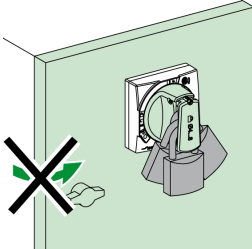
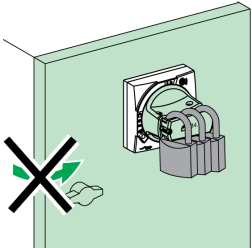
Lock position	Lock type	Lock characteristics	Lock image
<b>O (OFF)</b>	Standard padlocking	Up to 3 padlocks (not supplied) Diameter: 4–8 mm (3/16–5/16 in.)	
<b>I (ON) or O (OFF)</b> (Black door operator only)	Padlocking after modification of the door operator during installation	Up to 3 padlocks (not supplied) Diameter: 4–8 mm (3/16–5/16 in.)	
			

**Inserting Padlocks in the Handle**

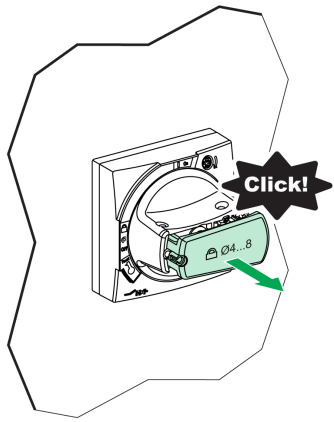
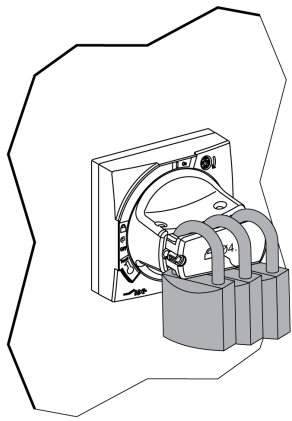
Step	Action	Comment
1	With the handle in the <b>O (OFF)</b> or <b>I (ON)</b> position, pull the cover on the front of the handle until you hear a click. A space opens between the handle and the cover.	
2	Insert the padlocks in the space.	

**Locking the Circuit Breaker in the O (OFF) Position When the Door Is Open**

The following procedure explains how to lock the circuit breaker itself, instead of the handle.

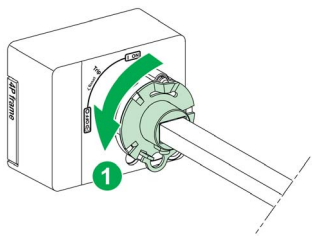
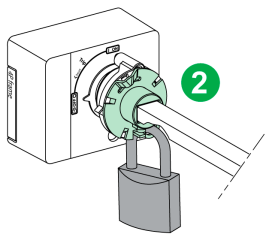
Step	Action	Comment
1	With the circuit breaker in the <b>O (OFF)</b> position, turn the locking plate anti-clockwise by 60 degrees to align the holes for the lock.	
2	Put a padlock or safety lockout hasp (4–8 mm, 3/16–5/16 in.) in the hole to lock the circuit breaker in the <b>O (OFF)</b> position.	

Overriding the Door Interlock

**⚡ ⚠ DANGER**

**HAZARD OF ELECTRIC SHOCK, EXPLOSION, OR ARC FLASH**

Overriding the door interlock must only be done by qualified electrical personnel.

**Failure to follow these instructions will result in death or serious injury.**

An interlock between the door and the circuit breaker position allows you to open the door only when the circuit breaker is open and the rotary handle is in the **O (OFF)** position.

When the rotary handle is in the **I (ON)** position or the **Trip** position, the door interlock prevents you from opening the door. To open the door, you must turn the handle to the **O (OFF)** position.

Under exceptional circumstances, qualified electrical personnel can follow these steps to open the door while the rotary handle is in the **I (ON)** position or the **Trip** position:

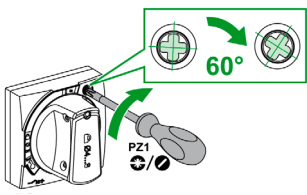
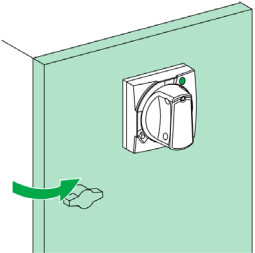
Step	Action	
1	Using a screwdriver, turn the locking screw clockwise by 60 degrees and hold the screwdriver in place.	
2	Open the door.	

To close the door, use a screwdriver to turn the locking screw clockwise by 60 degrees. Holding the screwdriver in place, close the door and then release the locking screw.

## Section 3.4

### Operating a Circuit Breaker with a Side Rotary Handle

---

#### What Is in This Section?

This section contains the following topics:

Topic	Page
Description	49
Opening, Closing, Resetting, and Testing the Circuit Breaker	50
Locking the Circuit Breaker	52



## Description

### Front Face

The controls, indicators, and locking mechanism are located on the following parts of the circuit breaker:

- The operating control is on the side plate.
- The operation indicators are on the circuit breaker and on the side plate.
- The locking mechanism is on the side plate.

The following figure shows the controls and indicators for a circuit breaker with a side rotary handle. Information about the other parts of the front face is available in the general description (*see page 11*).

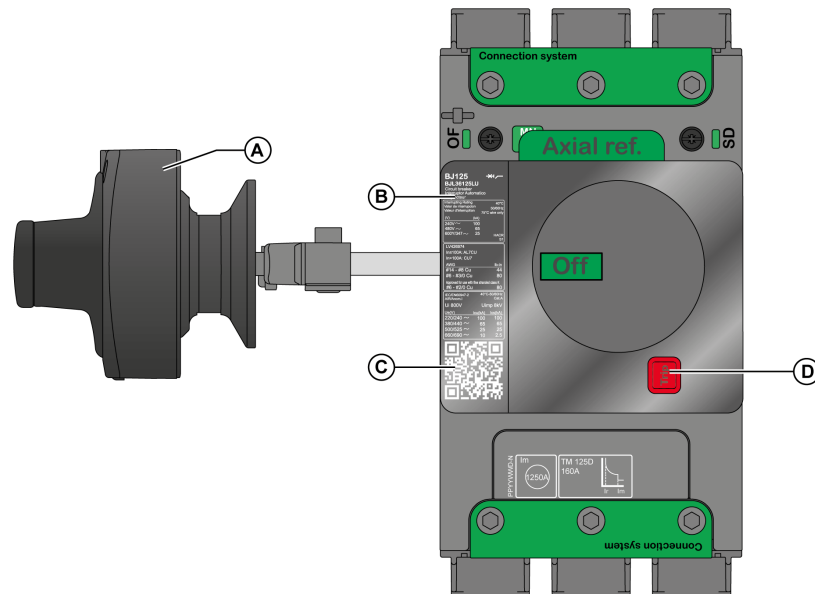

- A Side rotary handle
- B Device identification
- C QR code
- D Push-to-trip button

### Device Identification

Information about the circuit breaker is given on the device identification label (*see page 31*).

### QR Code

Scan the QR code to get additional information about the circuit breaker from the Schneider Electric website. To scan the QR code, use a smartphone that is equipped with a camera and installed with a QR code reader.

## Opening, Closing, Resetting, and Testing the Circuit Breaker

### Opening and Closing with the Side Rotary Handle

Open and close a circuit breaker with a side rotary handle in the same way as for a circuit breaker with an extended rotary handle (*see page 41*).

### Resetting with a Side Rotary Handle After a Trip

After a trip, reset a circuit breaker with a side rotary handle in the same way as for a circuit breaker with an extended rotary handle (*see page 42*).

### Testing the Trip Mechanism

 <b>CAUTION</b>
<p><b>HAZARD OF NUISANCE TRIPPING</b></p> <p>Circuit breaker tests must only be done by qualified electrical personnel.</p> <p><b>Failure to follow these instructions can result in injury or equipment damage.</b></p>

When testing the trip mechanism take precautions against:

- Disrupting operations
- Activating inappropriate alarms
- Triggering unwanted actions

For example, tripping the circuit breaker with the push-to-trip button can lead to inappropriate fault indications or corrective actions (such as switching to an alternate power source).

There is no push-to-trip button on the door of a circuit breaker with a side rotary handle. To check the trip mechanism, the door must first be opened.

Follow these steps to test the trip mechanism.

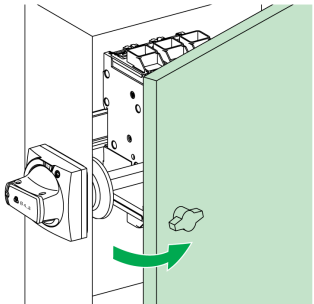
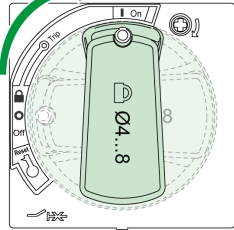
Step	Action		Position
1	With the circuit breaker in the <b>O (OFF)</b> position, open the enclosure door.		<b>O (OFF)</b>
2	Turn the circuit breaker from the <b>O (OFF)</b> position to the <b>I (ON)</b> position. The circuit breaker is ready for the test.		<b>I (ON)</b>

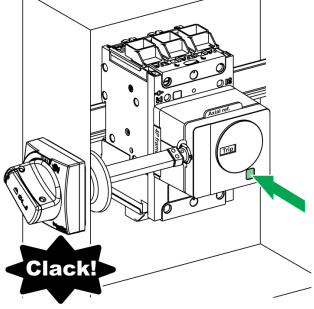
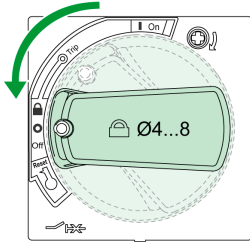
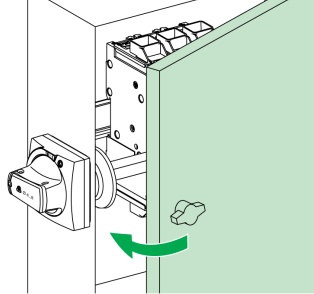
Step	Action		Position
3	Press the push-to-trip button. The circuit breaker trips.		Trip
4	Turn the circuit breaker from the Trip position to the <b>O (OFF)</b> position. The circuit breaker is open.		O (OFF)
5	Close the door.		-

## Locking the Circuit Breaker

### Locking Options with a Side Rotary Handle

**⚡ ⚠ DANGER**

**HAZARD OF ELECTRIC SHOCK, EXPLOSION, OR ARC FLASH**

When the circuit breaker handle is locked in the **O (OFF)** position, always use a properly rated voltage sensing device to confirm power is off before working on equipment.

**Failure to follow these instructions will result in death or serious injury.**

The side rotary handle offers a locking option to prevent the rotary handle from being operated.

The handle can be locked in the **O (OFF)** position or, in the case of the black side operator, in the **I (ON)** position.

No setup is required to lock the handle in the **O (OFF)** position.

Before the handle can be locked in the **I (ON)** position, the side operator must be dismantled and the physical setup of the handle must be changed. This is usually done at installation. For information about how to set up the handle to be locked in the **I (ON)**, position, see the relevant instruction sheet (*see page 7*).

**NOTE:** Locking the rotary handle in the **I (ON)** position does not disable the circuit breaker. If there is a fault detection, the circuit breaker still trips. When the rotary handle is unlocked, it moves to the **Trip** position.

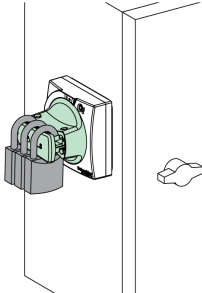
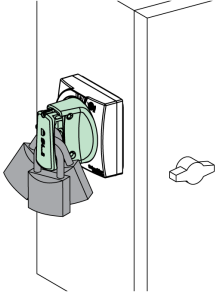
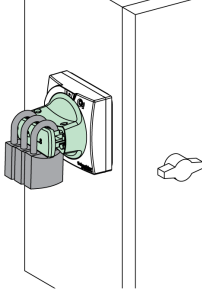
Lock position	Lock type	Lock characteristics	Lock image
<b>O (OFF)</b>	Standard padlocking	Up to 3 padlocks (not supplied) Diameter: 4–8 mm (3/16–5/16 in.)	
<b>I (ON) or O (OFF)</b> (Black side operator only)	Padlocking after modification of the side operator during installation	Up to 3 padlocks (not supplied) Diameter: 4–8 mm (3/16–5/16 in.)	
			

Inserting Padlocks in the Handle

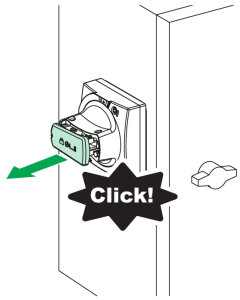
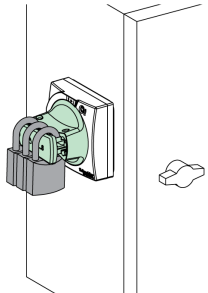
Step	Action	Comment
1	<p>With the handle in the <b>O (OFF)</b> or <b>I (ON)</b> position, pull the cover on the front of the handle until you hear a click. A space opens between the handle and the cover.</p>	
2	<p>Insert the padlocks in the space.</p>	



---

# Chapter 4

## PowerPact B-Frame Electrical Auxiliary Devices

---

### What Is in This Chapter?

This chapter contains the following topics:

Topic	Page
Electrical Auxiliary Devices	56
Indication Contacts	57
Control Auxiliaries	58

## Electrical Auxiliary Devices

### Summary of Electrical Auxiliary Devices

The following table shows electrical auxiliary devices that can be added to circuit breakers. Auxiliary contacts can be installed on site. For more information, see the *PowerPact B-Frame Catalog*.

Electrical auxiliary device	Use	1P	2P	3P/4P
OF auxiliary contact	View the on/off status of the circuit breaker remotely.	–	✓	✓
SD auxiliary contact	View the trip status of the circuit breaker remotely.	–	–	✓
MX shunt trip	Send an electrical trip command remotely.	–	✓	✓
MN undervoltage release	Trip the circuit breaker when the control voltage drops below a tripping threshold.	–	✓	✓
MN undervoltage release with time-delay unit.	Intended to avoid nuisance tripping in systems with frequent voltage dips lasting from 200 ms to 3 s.	–	✓	✓

### Slots for Electrical Auxiliary Devices

The following figures show the available slots for electrical auxiliary devices mounted in the case. One auxiliary can be installed in each slot. For more information, see the *PowerPact B-Frame Catalog*.

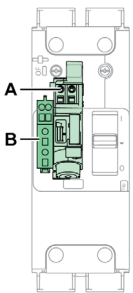
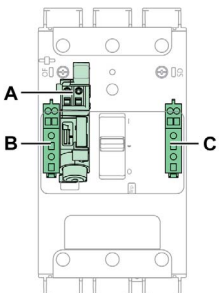
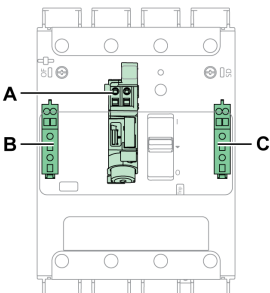
2P circuit breaker	3P circuit breaker	4P circuit breaker
		
<p>A. MN undervoltage release or MX shunt trip                      B. OF auxiliary contact                      C. SD auxiliary contact</p>		



## Indication Contacts

### Characteristics of Indication Contacts

Use indication contacts to view the status of the circuit breaker remotely.

Indication contacts are located under the front face of the circuit breaker, in a compartment that is isolated from the power circuits. When an indication contact is present, a green flag is displayed on the front of the circuit breaker.

The contacts used for indication contacts are *common point changeover contacts*.

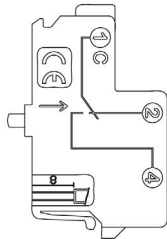

**C(1)** Common

**NC(2)** Normally closed contact. The NC contact is normally closed when the circuit breaker is in the **O (OFF)** position.

**NO(4)** Normally open contact. The NO contact is normally open when the circuit breaker is in the **O (OFF)** position.

**NOTE:** The indication contact provides either OF or SD indication functions, depending on its location in the circuit breaker.

Name	Definition
OF open / close indication contact	The OF contact indicates the state of the circuit breaker, (I (ON) or O (OFF)/Trip). Changeover <ul style="list-style-type: none"> <li>● O (OFF) to I (ON)</li> <li>● I (ON) to O (OFF)</li> <li>● I (ON) to Trip</li> </ul>
SD trip indication contact	The SD contact indicates that the circuit breaker has tripped due to: <ul style="list-style-type: none"> <li>● Operation of the push-to-trip button</li> <li>● Operation of the MX shunt trip or MN undervoltage release</li> <li>● Electrical fault detected by the protection</li> </ul> Changeover <ul style="list-style-type: none"> <li>● I (ON) to Trip</li> <li>● Trip to O (OFF)</li> </ul>

### Operation of the Auxiliary Indication Contacts

The following figures show the position of the indication contacts for each position of the handle and main contacts.

Name	Contact number	Position of the handle and contacts		
		OFF	ON	Tripped (by MN/MX, push-to-trip, or protection)
Device status	-			
Handle position	-			
Main contact position	-	Open	Closed	Open
OF auxiliary contact position	1-2	Closed	Open	Closed
	1-4	Open	Closed	Open
SD auxiliary contact position	1-2	Closed	Closed	Open
	1-4	Open	Open	Closed

## Control Auxiliaries

### Remote Electrical Trip

The following voltage release auxiliaries are operated remotely by an electrical trip command:

- MX shunt trip
- MN undervoltage release
- MN undervoltage release with time-delay unit. The time-delay unit helps to overcome nuisance tripping due to transient voltage dips. The time delay is adjustable up to three seconds.

**NOTE:** It is recommended to test the operation of a remote electrical trip at regular intervals, such as every six months.

Voltage release auxiliaries are installed in the case under the front face of the circuit breaker. The presence and characteristics of a voltage release auxiliary are displayed through a window on the front face.

The characteristics of voltage release auxiliaries comply with IEC/EN60947-2 recommendations.

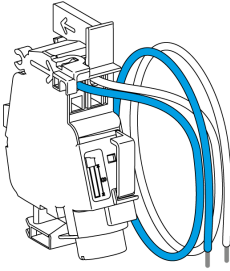
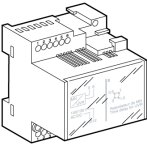
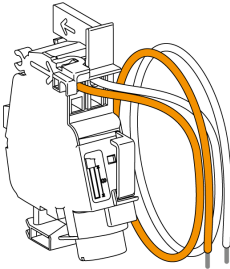
Name	Image	Description
<b>MN undervoltage release</b>		<ul style="list-style-type: none"> <li>● Trips the circuit breaker when the voltage is less than 0.35 times the rated voltage (<math>U_n</math>).                             <ul style="list-style-type: none"> <li>○ If the voltage is between 0.35 and 0.7 times the rated voltage (<math>U_n</math>), tripping can occur but is not certain to occur.</li> <li>○ If the voltage is above 0.7 times the rated voltage (<math>U_n</math>), tripping cannot occur.</li> </ul> </li> <li>● Allows the circuit breaker to be closed again when the voltage reaches 0.85 times the rated voltage (<math>U_n</math>).</li> </ul> <p>Use this type of accessory for failsafe emergency stops.</p>
<b>Time-delay unit for MN undervoltage release</b>		<p>Removes nuisance tripping of an undervoltage release by setting a time delay of up to 3 s to overcome transient voltage dips.</p> <p>Adjustable and fixed time-delay units are available.</p>
<b>MX shunt trip</b>		<p>Trips the circuit breaker when the voltage exceeds 0.7 times the rated voltage (<math>U_n</math>).</p> <p><b>NOTE:</b> MX shunt trip 110/130 Vac combined with Class I ground-fault sensing element is suitable for ground-fault protection. In this application, the circuit breaker trips when the voltage exceeds 0.55 times the rated voltage (<math>U_n</math>).</p>

---

# Chapter 5

## Commissioning and Maintaining the PowerPact B-Frame

---

### What Is in This Chapter?

This chapter contains the following topics:

Topic	Page
Commissioning the Circuit Breaker	60
Maintaining the Circuit Breaker During Operation	62
Responding to a Trip	64
Troubleshooting	66

## Commissioning the Circuit Breaker

### List of Checks and Inspections

 **DANGER**

**HAZARD OF ELECTRIC SHOCK, EXPLOSION, OR ARC FLASH**

- Apply appropriate personal protective equipment (PPE) and follow safe electrical work practices. See NFPA 70E, CSA Z462, NOM-029-STPS, or local equivalent.
- This equipment must only be installed and serviced by qualified electrical personnel.
- Turn off all power supplying this equipment before working on or inside equipment.
- Always use a properly rated voltage sensing device to confirm that power is off.
- Replace all devices, doors, and covers before turning on power to this equipment.
- Beware of potential hazards, and carefully inspect the work area for tools and objects that may have been left inside the equipment.

**Failure to follow these instructions will result in death or serious injury.**

When equipment is commissioned or returned to service after a lengthy downtime, perform a general check on the equipment.

The following table summarizes when to carry out checks or inspections:

When to carry out the check or inspection	A	B	C	D	E	F	G
Before commissioning new equipment	✓	✓	✓	✓	✓	✓	✓
Periodically during operation <i>(see page 62)</i>	✓	—	—	—	✓	✓	✓
After carrying out work on the switchboard	—	—	✓	✓	✓	✓	✓
Periodically during lengthy downtime	—	—	✓	—	✓	—	✓
After a lengthy downtime	—	—	✓	—	✓	✓	✓
After a lengthy downtime and modification to the switchboard	✓	✓	✓	✓	✓	✓	✓
<b>A</b> Carry out insulation tests and dielectric strength tests <b>B</b> Carry out temperature rise tests <b>C</b> Inspect switchboard <b>D</b> Check compliance with the diagram <b>E</b> Inspect mechanical equipment <b>F</b> Check mechanical operation <b>G</b> Clean equipment							

### A: Insulation Tests and Dielectric Strength Tests

 **CAUTION**

**HAZARD OF EQUIPMENT DAMAGE**

Insulation and dielectric strength tests must only be carried out by qualified electrical personnel.

**Failure to follow these instructions can result in injury or equipment damage.**

Insulation tests and dielectric strength tests are done before the switchboard is delivered. These tests are compliant with the currently applicable standards.

Dielectric strength tests impose great stress on the equipment and can cause damage if performed incorrectly. Reduce the value used for the test voltage depending on the number of consecutive tests on the same piece of equipment.

### B: Temperature Rise Tests

Temperature rise tests are done before the switchboard is delivered. PowerPact B-frame circuit breakers comply with product standards IEC60947-1 and 2.

For general-purpose systems, tests are carried out at an ambient temperature of 40 °C (104 °F). Above 40 °C (104 °F), thermal protection characteristics are slightly modified and the values defined in the derating tables must be taken into account. These values are valid for circuit breakers with or without terminal shields.

### C: Inspect Switchboard

Check that the circuit breakers are installed:

- In a clean environment, without waste from assembling the equipment (such as wiring, tools, shavings, metallic particles).
- In a properly ventilated switchboard (unobstructed ventilation grills).

### D: Check Compliance with the Diagram

Check that the circuit breakers comply with the installation diagram:

- Identification of the feeds on the front of the circuit breakers
- Rating and breaking capacity (shown on the device identification label)
- Presence of additional functions (rotary handle, control, or indication auxiliaries, locking, sealing)

### E: Inspect Mechanical Equipment

Visually inspect the general state of the circuit breakers: terminal shields and interphase barriers, protection, case, and connections.

Check the equipment integrity: a circuit breaker found with a cracked case or burn marks must be immediately taken out of service and replaced.

Check the mounting and mechanical strength of the following equipment:

- Circuit breakers in the switchboard, power connections, and heat sinks
- Auxiliaries and accessories on the circuit breakers:
  - Rotary handles
  - Installation accessories, such as terminal shields and interphase barriers
  - Auxiliary circuit connections
- Locks, padlocks, and padlock support tabs

### F: Check Mechanical Operation

Check the mechanical operation of the circuit breaker:

- Opening
- Closing
- Tripping with the push-to-trip button
- Resetting

### G: Clean Equipment

To reduce dust deposits that can affect the mechanical operation of circuit breakers, clean the circuit breakers when performing maintenance:

- Non-metallic parts: Always use a dry cloth. Do not use cleaning products.
- Metallic parts: Preferably use a dry cloth. If a cleaning product is used, do not apply or splash the cleaning product on non-metallic parts.

## Maintaining the Circuit Breaker During Operation

### Introduction

DANGER

**HAZARD OF ELECTRIC SHOCK, EXPLOSION, OR ARC FLASH**

- Apply appropriate personal protective equipment (PPE) and follow safe electrical work practices. See NFPA 70E, CSA Z462, NOM-029-STPS, or local equivalent.
- This equipment must only be installed and serviced by qualified electrical personnel.
- Turn off all power supplying this equipment before working on or inside equipment.
- Always use a properly rated voltage sensing device to confirm that power is off.
- Replace all devices, doors, and covers before turning on power to this equipment.
- Beware of potential hazards, and carefully inspect the work area for tools and objects that may have been left inside the equipment.

**Failure to follow these instructions will result in death or serious injury.**

Like most equipment, electrical switchboards age whether they are being used or not. Aging is mostly caused by environmental influences and operating conditions.

To help circuit breakers keep the operating and safety characteristics specified in the catalog for the whole of their service life:

- Install circuit breakers in optimum environmental and operating conditions (described in the following table).
- Make sure that maintenance operations are carried out by qualified electrical personnel.

### Environmental and Operating Conditions

The following table describes optimum environmental and operating conditions.

Environmental and operating factor	Optimum conditions
Temperature	Average annual temperature outside the switchboard is < 25 °C (77 °F).
Loading	Loading is < 80% of In for 24 hours a day.
Harmonics	Harmonic current per phase is < 30% of In.
Humidity	Relative humidity is < 70%.
Corrosive atmosphere (SO <sub>2</sub> , NH <sub>3</sub> , H <sub>2</sub> S, Cl <sub>2</sub> , NO <sub>2</sub> )	The circuit breaker is installed in environmental category 3C1 or 3C2 (IEC60721-3-3).
Saline environment	The circuit breaker is installed in an environment free of salt mist.
Dust	The dust level is low. If necessary, the circuit breaker is in a switchboard that is fitted with filters or is IP54 ventilated.
Vibration	Continuous vibration is < 0.2 g.

Maintenance programs apply to optimum environmental and operating conditions. Outside these limits, circuit breakers are subject to accelerated aging, which can quickly lead to problems.

In harsh environmental and operating conditions, you must refer to the derating tables and reduce the maintenance intervals (*see page 15*).

**Regular Preventive Maintenance**

Maintenance recommendations for each product are intended to maintain the equipment or subassemblies in a satisfactory operational state for their useful service life.

The following table summarizes maintenance operations and intervals for the three preventive maintenance levels:

Maintenance interval	Maintenance operations	Performed by
1 year	Basic level tasks: visual inspection and functional testing, replacement of inoperative accessories.	<ul style="list-style-type: none"> <li>• Qualified customer employee with basic training</li> <li>• Schneider Electric certified partner</li> <li>• Schneider Electric field service representative</li> </ul>
2 years	Advanced level tasks: Basic level tasks, plus operational servicing and subassembly tests.	<ul style="list-style-type: none"> <li>• Qualified technician with advanced training</li> <li>• Schneider Electric certified partner</li> <li>• Schneider Electric field service representative</li> </ul>
5 years	Exclusive level tasks: Advanced level tasks, plus manufacturer diagnostics and part replacements by Schneider Electric Services.	<ul style="list-style-type: none"> <li>• Schneider Electric field service representative</li> </ul>

The maintenance intervals in the previous table are for normal environmental and operating conditions. If all environmental conditions are more favorable, maintenance intervals can be longer. For example, Advanced level tasks could be carried out every 3 years.

If any one of the conditions is more severe, perform maintenance more frequently. For advice, contact Schneider Electric Services.

Functions linked specifically to safety require particular maintenance intervals.

**NOTE:** Regularly test that the remote safety commands work. For example, test at least every six months.

**Maintenance Operations Required**

Maintenance operations mainly consist of checks and inspections A, E, F, and G, as defined for the commissioning phase (see page 60).

⚠ CAUTION
HAZARD OF EQUIPMENT DAMAGE
Insulation and dielectric strength tests must only be carried out by qualified electrical personnel.
Failure to follow these instructions can result in injury or equipment damage.

Maintenance operation	Year 1	Year 2	Year 3	Year 4	Year 5
Insulation and dielectric strength tests (A)	✓	✓	✓	✓	✓
Inspect mechanical equipment (E)	✓	✓	✓	✓	✓
Measurement of insulation resistance	—	—	—	—	✓
Check mechanical operation (F)	✓	✓	✓	✓	✓
Check the closing time, opening time, and voltage release characteristics	—	✓	—	✓	✓
Clean equipment (G)	✓	✓	✓	✓	✓

For a detailed definition of the maintenance operations, contact Schneider Electric Services.

## Responding to a Trip

### Taking Precautions Before Responding to a Trip

 <b>DANGER</b>
<p><b>HAZARD OF ELECTRIC SHOCK, EXPLOSION, OR ARC FLASH</b></p> <ul style="list-style-type: none"><li>● Apply appropriate personal protective equipment (PPE) and follow safe electrical work practices. See NFPA 70E, CSA Z462, NOM-029-STPS, or local equivalent.</li><li>● This equipment must only be installed and serviced by qualified electrical personnel.</li><li>● Turn off all power supplying this equipment before working on or inside equipment.</li><li>● Always use a properly rated voltage sensing device to confirm that power is off.</li><li>● Replace all devices, doors, and covers before turning on power to this equipment.</li><li>● Beware of potential hazards, and carefully inspect the work area for tools and objects that may have been left inside the equipment.</li></ul> <p><b>Failure to follow these instructions will result in death or serious injury.</b></p>

Before inspecting electrical equipment downstream of the protection, always isolate the feed.

### Identifying the Cause of the Trip

A trip can be caused by the following events:

- Fault detection on the installation
- Fault detection caused by malfunction
- Intentional tripping

Check the circuit breaker and the electrical installation to find the root cause of the trip.

### Checking Equipment After a Trip

 <b>CAUTION</b>
<p><b>HAZARD OF CLOSING ON ELECTRICAL FAULT</b></p> <p>Do not close the circuit breaker without first inspecting and, if necessary, repairing the downstream electrical equipment.</p> <p><b>Failure to follow these instructions can result in injury or equipment damage.</b></p>

**NOTE:** Checks, tests, and inspections must be carried out by qualified electrical personnel.

The fact that the protection has tripped does not fix the cause of the fault detected on the downstream equipment.

Perform the following tasks after a short-circuit:

- Carefully clean off any traces of black smoke. The smoke particles can conduct electricity.
- Check the power connections and control wires.
- Operate the circuit breaker at least five times at zero load.

Depending on the type of fault detected, perform the following inspections on all or part of the equipment where the fault occurred (*see page 60*):

- For faults tripped by thermal protection:
  - Check system for damage and repair if necessary.
  - Perform checks E and F.
- For faults tripped by magnetic protection or caused by an unknown reason:
  - Check the system for damage, and then repair if necessary.
  - Perform checks A, E, and F.



### Resetting the Circuit Breaker

Before resetting the circuit breaker, make sure that the fault is identified and repaired, and that the installation has been checked.

If the system must be restarted quickly (for example, in a safety installation), isolate and lock out the affected part of the installation before carrying out maintenance.

The procedure for resetting a circuit breaker depends on the type of handle on the circuit breaker (*see page 23*).

## Troubleshooting

### Repetitive Tripping

Indication	Probable cause	Checks or repairs
SD	The voltage of the power supply to the MN undervoltage release is too low or subject to significant variations.	Check the power supply for the release. For example, a supply powering motors with high-power ratings can be unstable. If necessary, connect the release to a clean or stable supply.
	The power supply to an MX shunt trip is applied unintentionally.	Compare the release connection with the installation diagram to make sure that it is correct.

### Circuit Breaker Does Not Close

Indication	Probable cause	Checks or repairs
SD	MX shunt trip energized. MN undervoltage release not energized.	Compare the release connection with the installation diagram to make sure that it is correct.

---

# Appendices

---





# Appendix A

## Wiring Diagrams

### Circuit Breakers

#### Introduction

The diagrams are shown with circuits de-energized, all devices open, connected, and charged, and relays in normal position.

Terminals shown in red  must be connected by the customer.

#### Indication Contacts

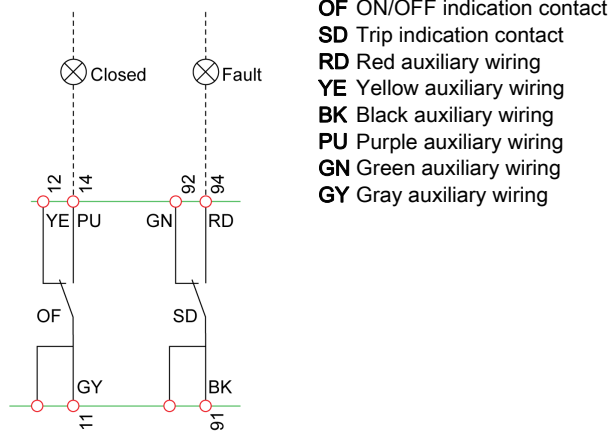

#### Remote Operation

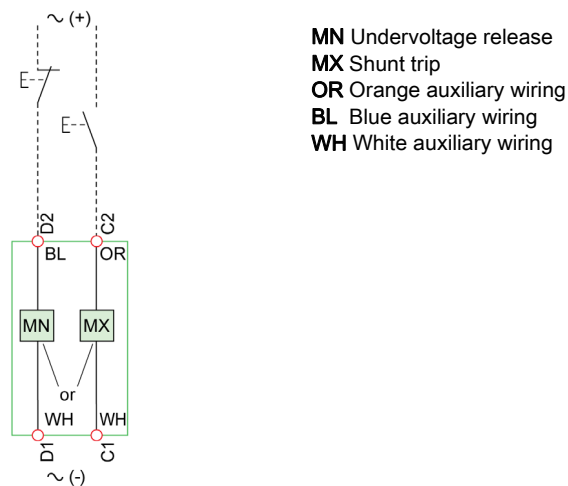





## A

auxiliaries  
  control, *58*  
auxiliary contacts  
  operation, *57*  
auxiliary devices, *55*  
auxiliary slots, *56*

## C

checks  
  commissioning, *60*  
  maintenance, *62*  
circuit breakers  
  auxiliary slots, *56*  
  close, *27, 33*  
  commissioning, *60*  
  commissioning and maintaining, *59*  
  description, *11*  
  features, *10*  
  locking, *29*  
  maintenance, *62*  
  open, *27, 33*  
  reset, *34, 42*  
  testing, *28, 35, 43, 50*  
  toggle handle, *25*  
close, *27, 33*  
  front extended rotary handle, *41*  
control auxiliaries, *58*

## E

electrical accessories, *17*

## I

indication contacts  
  auxiliary slots, *56*  
  operation, *57*  
insulation accessories, *17*  
insulation requirements, *17*

## L

locking  
  circuit breakers, *29*

## O

open, *27, 33*

## R

reset, *34, 42*

## S

sealing accessories, *13*

## T

testing  
  circuit breakers, *28, 35, 43, 50*  
  trip mechanism, *28, 35, 43, 50*  
trip mechanism  
  testing, *28, 35, 43, 50*



**DOCA0094EN-01**

**Schneider Electric Industries SAS**

35, rue Joseph Monier  
CS30323  
F - 92506 Rueil Malmaison Cedex

[www.schneider-electric.com](http://www.schneider-electric.com)

*As standards, specifications and designs change from time to time, please ask for confirmation of the information given in this publication.*

12/2016