



3” Indoor Dome Series Hardware Manual

D51, D52, D54, D55

E51, E52, E53, E54, E56, E57, E58,
E59

Ver. 2014/12/17



ACTi
Connecting Vision

Table of Contents

Precautions **4**

Safety Instructions	6
---------------------------	---

Introduction **7**

List of Models.....	7
Package Contents.....	8
Physical Description	9
D51 / D52 / E51	9
D54 / D55 / E52 / E53 / E54 / E56 / E57 / E58 / E59	9
Mounting Solutions	10
Other Mounting Accessories	12

Installing the Camera on a Surface **13**

Step 1: Unpack the Camera	13
Step 2: Attach the Mounting Plate.....	14
Step 3: Connect the Cable	15
Step 4: Attach the Fixing Bracket.....	16
Step 5: Install the Camera.....	17
Step 6: Connect to Network.....	18
Step 7: Access the Camera Live View.....	18
Step 8: Adjust the Viewing Angle and Focus	19
Step 9: Close the Dome Cover.....	19

Other Adjustments and Accessories **21**

How to Adjust the Viewing Angle and Focus	21
D51 / D52 / E51	21
D54 / D55 / E52 / E53 / E54 / E56 / E57 / E59.....	22
How to Replace the Dome Cover.....	23

Accessing the Camera

25

Configure the IP Addresses	25
Using DHCP Server to Assign IP Addresses.....	25
Using the Default Camera IP Address.....	27
Access the Camera.....	29

Precautions

Read these instructions

You should read all the safety and operating instructions before using this product.

Heed all warnings

You must adhere to all the warnings on the product and in the instruction manual. Failure to follow the safety instruction given may directly endanger people, cause damage to the system or to other equipment.

Servicing

Do not attempt to service this video device yourself as opening or removing covers may expose you to dangerous voltage or other hazards. Refer all servicing to qualified service personnel.

Trademarks

All names used in this manual are probably registered trademarks of respective companies.

Liability

Every reasonable care has been taken during the writing of this manual. Please inform your local office if you find any inaccuracies or omissions. We cannot be held responsible for any typographical or technical errors and reserve the right to make changes to the product and manuals without prior notice.

Federal Communications Commission Statement



This equipment has been tested and found to comply with the limits for a class B digital device, pursuant to Part 15 of the FCC Rules. These limits are designed to provide reasonable protection against harmful interference in a residential installation. This equipment generates, uses, and can radiate radio frequency energy and, if not installed and used in accordance with the instructions, may cause harmful interference to radio communications. However, there is no guarantee that interference will not occur in a particular installation. If this equipment does cause harmful interference to radio or television reception, which can be determined by turning the equipment off and on, the user is encouraged to try to correct the interference by one or more of the following measures:

- Reorient or relocate the receiving antenna.
- Increase the separation between the equipment and receiver.
- Connect the equipment into an outlet on a circuit different from that to which the receiver is connected.
- Consult the dealer or an experienced radio/TV technician for help.

Warning: Changes or modifications to the equipment that are not expressly approved by the responsible party for compliance could void the user's authority to operate the equipment.

European Community Compliance Statement



This product has been tested and found to comply with the limits for Class B Information Technology Equipment according to European Standard EN 55022 and EN 55024. In a domestic environment, this product may cause radio interference in which cause the user may be required to take adequate measures.

Safety Instructions

Don't open the housing of the product

Cleaning

Disconnect this video product from the power supply before cleaning.

Attachments

Do not use attachments not recommended by the video product manufacturer as they may cause hazards.

Water and Moisture

Do not use this video product near water, for example, near a bathtub, washbowl, kitchen sink, or laundry tub, in a wet basement, or near a swimming pool and the like.

Don't use accessories not recommended by the manufacturer

Only install this device in a dry place protected from weather

Servicing

Do not attempt to service this video product yourself as opening or removing covers may expose you to dangerous voltage or other hazards. Refer all servicing to qualified service personnel.

Damage Requiring service

Disconnect this video product from the power supply immediately and refer servicing to qualified service personnel under the following conditions.

- 1) When the power-supply cord or plug is damaged
- 2) If liquid has been spilled, or objects have fallen into the video product.
- 3) If the video product has been directly exposed to rain or water.
- 4) If the video product does not operate normally by following the operating Instructions in this manual. Adjust only those controls that are covered by the instruction manual, as an improper adjustment of other controls may result in damage, and will often require extensive work by a qualified technician to restore the video product to its normal operation.

Safety Check

Upon completion of any service or repairs to this video product, ask the service technician to perform safety checks to determine if the video product is in proper operating condition.

Indoor Use Only

The camera and the Power-over-Ethernet (PoE) connection must be installed and connected only indoors.

Introduction

List of Models

This hardware manual contains the following models:

D51		1MP Indoor Dome with Fixed Lens
D52		3MP Indoor Dome with Fixed Lens
D54		1MP Indoor Dome with D/N, IR, Fixed lens
D55		3MP Indoor Dome with D/N, IR, Fixed lens
E51		1MP Indoor Dome with Basic WDR, Fixed lens
E52		1MP Indoor Dome with D/N, IR, Basic WDR, Fixed lens
E53		3MP Indoor Dome with D/N, IR, Basic WDR, Fixed lens
E54		5MP Indoor Dome with D/N, IR, Basic WDR, Fixed lens
E56		3MP Indoor Dome with D/N, IR, Superior WDR, Fixed lens
E57		1.3MP Indoor Dome with D/N, IR, Basic WDR, SLLS, Fixed lens
E58		2MP Indoor Dome with D/N, IR, Basic WDR, SLLS, Fixed lens
E59		10MP Indoor Dome with D/N, IR, Basic WDR, Fixed lens

From the installation perspective, these models are similar; therefore, one manual is used for all of them.

Package Contents

Camera	
	or
Mounting Screw Kit	Drill Template
Lens Focus Tuner (Not available in D51, D52, E51, E59)	Fixing Bracket and Screws (Not available in D51, D52, E51)
Quick Installation Guide	Warranty Card

Physical Description

D51 / D52 / E51

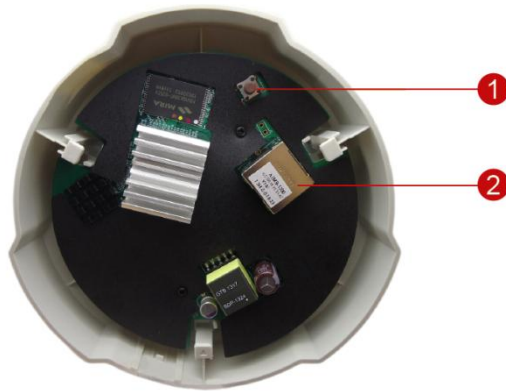

1) Reset Button

2) Ethernet Port

D54 / D55 / E52 / E53 / E54 / E56 / E57 / E58 / E59

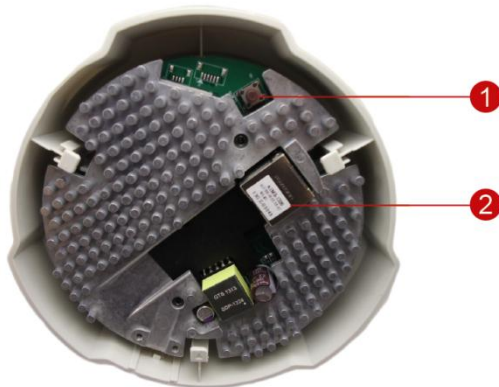

1) Reset Button

2) Ethernet Port

1) Ethernet Port









Connects to the network using a standard Ethernet cable (CAT5 / CAT6).

















2) Reset Button

Restores the camera factory default settings. To do the reset, press and hold the Reset Button for at least 5 seconds or until the Ethernet port LEDs turn off.

Mounting Solutions

There are several mounting solutions that you can use to install the camera. Select the most suitable solution for your installation environment.

Mount Types	Accessories
Surface Mount	Suitable when mounting the camera directly to walls or ceilings. See Installing the Camera on a Surface on page 13 for mounting instructions.
Flush Mount	Suitable when mounting the camera discretely above dropped ceilings wherein only the dome cover will be visible underneath the ceiling.
	PMAX-1006 
Gang Box	Suitable when mounting the camera in specific regions where the use of gang box is required by law.
	PMAX-0803 
Pendant Mount	Suitable when mounting the camera on hard and high ceilings.
	PMAX-0101 PMAX-0103 (Straight Tube with Bracket)   
	PMAX-0101 PMAX-0102 (Straight Tube)   

Straight Wall Mount	Suitable when mounting the camera on straight walls.		
	PMAX-0316 		
	PMAX-0101 		PMAX-0305 (Heavy Duty Wall Mount) 
Vertical Pole Mount	Suitable when mounting the camera on vertical poles.		
	PMAX-0101 		PMAX-0305 
			PMAX-0503 
Horizontal Pole Mount	Suitable when mounting the camera on horizontal poles.		
	PMAX-0101 		PMAX-0102 
			PMAX-0503 
Corner Mount	Suitable when mounting the camera on a corner wall.		
	PMAX-0101 	PMAX-0305 	PMAX-0402 

Other Mounting Accessories

Accessories	
PMAX-0104 (Extension Tube) 	

NOTE:

- For more information about the mounting solutions and accessories, please check the *Mounting Accessory Selector* in our website (<http://www.acti.com/mountingselector>).
- The above mounting accessories are not included in the package. Contact your sales agents to purchase.

Installing the Camera on a Surface

This section describes the procedures in installing the camera directly on a flat surface, such as the ceiling or the wall. For simplicity, most of the camera images used in the succeeding sections were taken using the camera model with heat sink; same procedures apply to the model without heat sink unless specified.

Step 1: Unpack the Camera

NOTE: To avoid scratches or leaving fingerprints on the dome cover, it is recommended to retain the plastic covering the dome cover until the camera is completely installed.

1. Slide the mounting plate counter-clockwise to detach it from the camera.



2. Remove the silicon bag.



Step 2: Attach the Mounting Plate

NOTE: Before installation, consider the camera viewing angle and logo placement. The arrow on the drill template and mounting plate align with the direction of the camera logo. Rotate the drill template as needed.

- Using the drill template, mark the holes on the surface. If necessary, drill the three (3) screw holes and insert the plastic plugs.

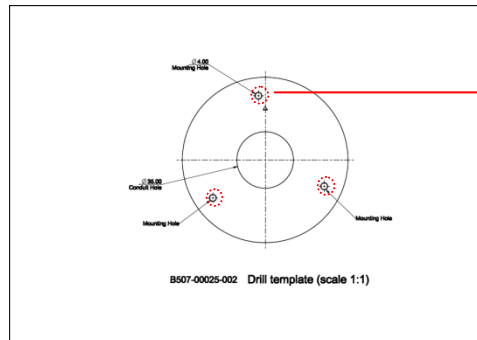

This arrow aligns with the camera logo. Rotate the template, as needed.

- Determine how the cable will be routed:
 - The cable will pass through a hole on the surface:** In this case, drill the cable hole based on the drill template.
 - The cable will go along the surface:** Skip this step.
- Attach the mounting plate on the surface using the three (3) supplied screws. Note that the direction of the arrow on the mounting plate aligns with the camera logo.

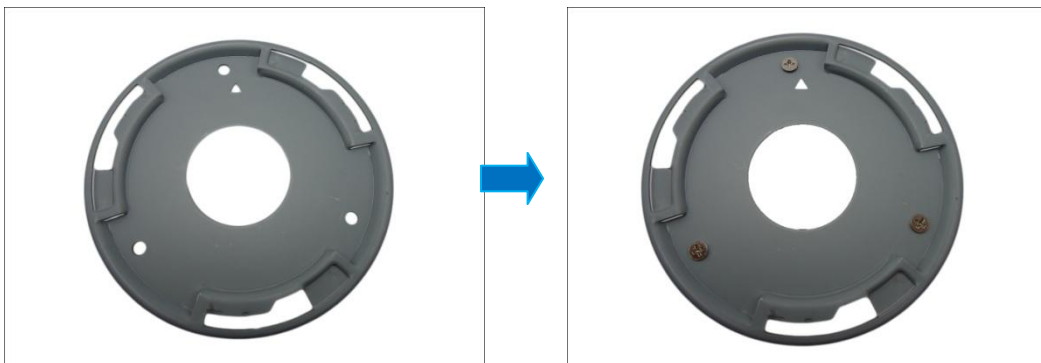

NOTE: Make sure the screw is flat on the plate.



Step 3: Connect the Cable

1. **If the cable will pass through the hole on the surface**, route the network cable through the hole. **If the cable will go along the surface**, remove the cable exit tab on the camera and route the cable along the surface.



Cable Passing Through a Hole on the Surface

or



Cable Going Along the Surface

2. Connect the network cable to the Ethernet port of the camera.



Step 4: Attach the Fixing Bracket

This step is required only for D54, D55, E52, E53, E54, E56, E57, E58, E59 camera models **with cables going along the surface**. Otherwise, skip this step.

1. Route the cable to pass through the gap on the camera.

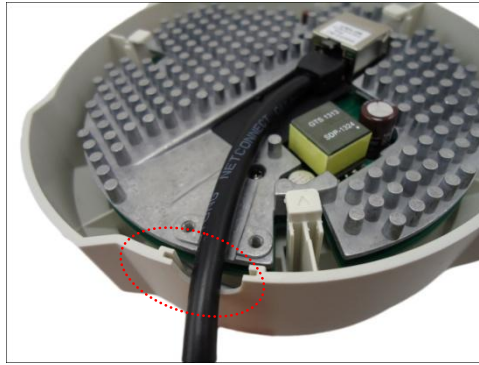

2. Attach the fixing bracket using the two (2) supplied screws to secure the cable.

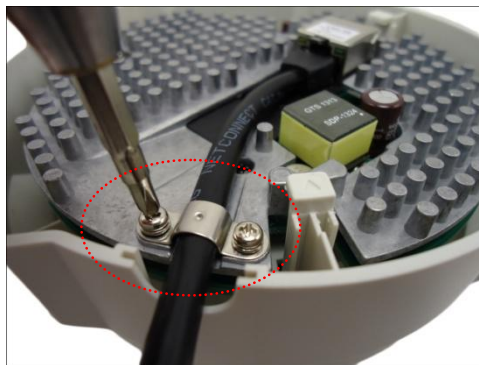

Step 5: Install the Camera

1. **If the cable passes through a hole on the surface**, push the extra length of cable into the hole. Otherwise, skip this step.



2. With the arrow on the mounting plate aligned to the direction of the camera logo, insert the hooks on the camera to the slots on the mounting plate.



3. Slide the camera clockwise until it locks into place.



Step 6: Connect to Network

Connect the other end of the network cable to a Power-over-Ethernet (PoE) switch or injector. Then, connect the PoE switch or injector to a network or PC and a power source. See example connection diagram below.

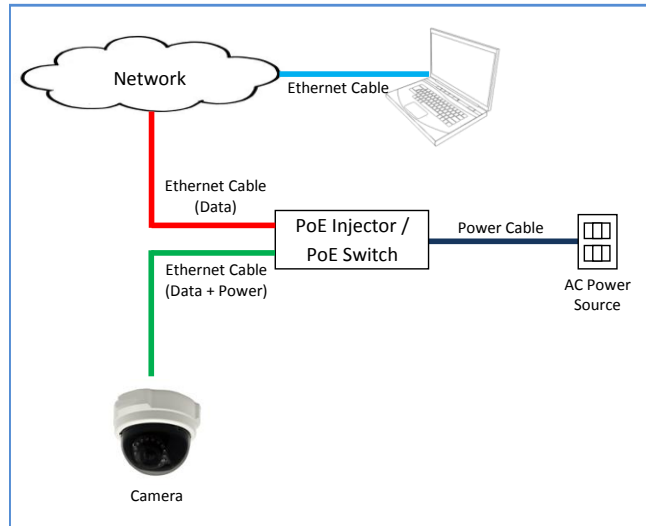

NOTE: The use of UL Listed PoE switch / injector with the camera is recommended.

Step 7: Access the Camera Live View

See [Accessing the Camera](#) on page 25 for more information on how to access the Live View screen of the camera.

Step 8: Adjust the Viewing Angle and Focus

1. Rotate the dome cover counter-clockwise and then pull to remove it.



2. Based on the live view, adjust the viewing angle and orientation of the camera. Adjustments vary depending on model; see [How to Adjust the Viewing Angle and Focus](#) on page 21 for detailed information.

Step 9: Close the Dome Cover

1. Slightly press on the edges of the dome cover and push it into the groove until it clicks.



2. Remove the plastic covering the dome cover.



Below is an installation example.



Other Adjustments and Accessories

How to Adjust the Viewing Angle and Focus

This section describes the procedures in adjusting the viewing angle and focus of the camera.

D51 / D52 / E51

Camera Parts Overview

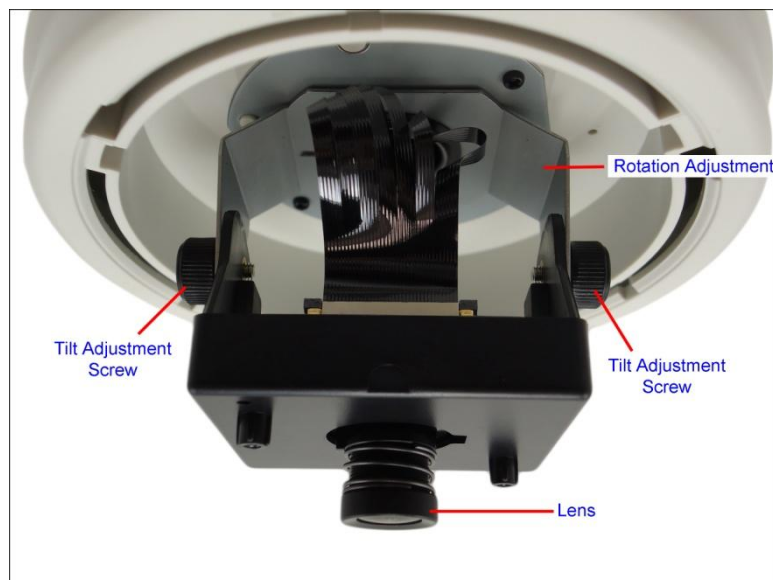

Adjustment Procedures

1. Loosen the tilt adjustment screws, adjust the tilt, and then tighten back the screws to fix the tilt position.
2. Move the rotation adjustment to rotate the viewing orientation.
3. Attach the bundled lens focus tuner unto the lens and turn left or right to adjust the focus.

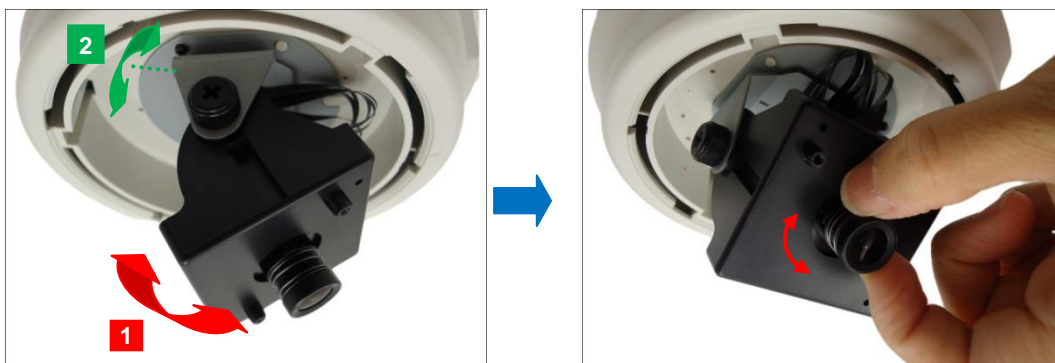

D54 / D55 / E52 / E53 / E54 / E56 / E57 / E59

Camera Parts Overview

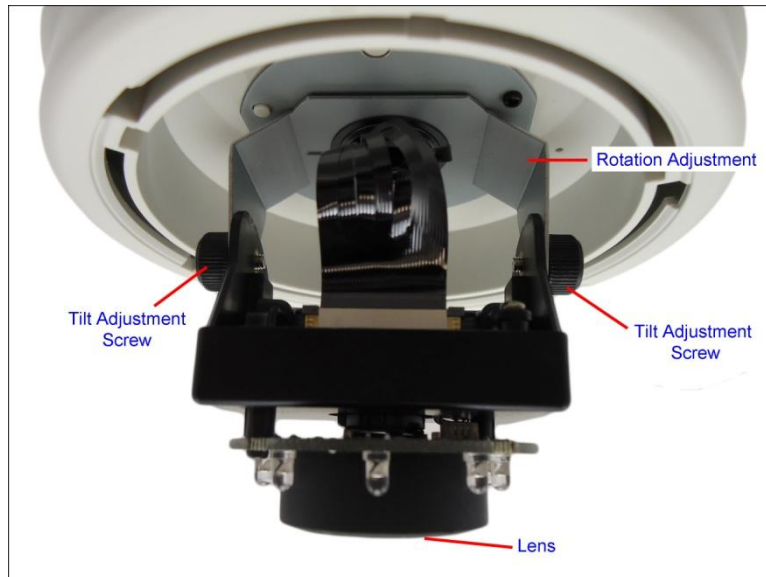

Adjustment Procedures

1. Loosen the tilt adjustment screws, adjust the tilt, and then tighten back the screws to fix the tilt position.
2. Move the rotation adjustment to rotate the viewing orientation.

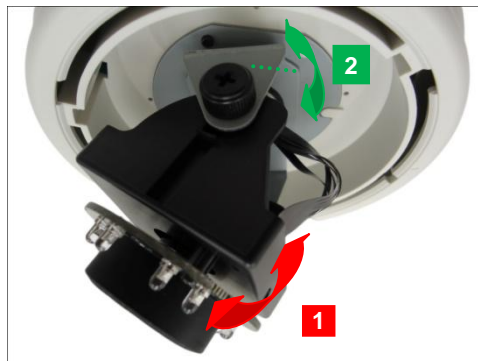

3. Attach the bundled lens focus tuner onto the lens and turn left or right to adjust the focus.
NOTE: Focus adjustment is not available for E59 because the camera already comes with fixed focus and fixed viewing angle.



How to Replace the Dome Cover

For more discrete surveillance needs, the bundled dome cover can be replaced with a smoke dome cover available for purchase. To replace the dome cover, do the following:

1. Rotate the current dome cover counter-clockwise and then pull to remove it.



2. Align the shroud of the replacement dome cover to the camera lens.



3. Slightly press on the edges of the dome cover and push it into the groove until it clicks.



4. Remove the plastic covering the dome cover.

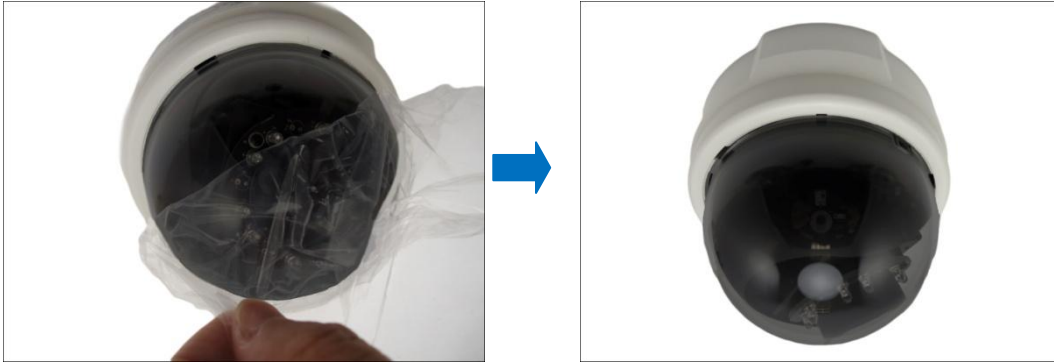

Accessing the Camera

Configure the IP Addresses

In order to be able to communicate with the camera from your PC, both the camera and the PC have to be within the same network segment. In most cases, it means that they both should have very similar IP addresses, where only the last number of the IP address is different from each other. There are 2 different approaches to IP Address management in Local Area Networks – by DHCP Server or Manually.

Using DHCP Server to Assign IP Addresses

If you have connected the computer and the camera into the network that has a DHCP server running, then you do not need to configure the IP addresses at all – both the camera and the PC would request a unique IP address from DHCP server automatically. In such case, the camera will immediately be ready for the access from the PC. The user, however, might not know the IP address of the camera yet. It is necessary to know the IP address of the camera in order to be able to access it by using a Web browser.

The quickest way to discover the cameras in the network is to use the simplest network search, built in the Windows system – just by pressing the “Network” icon, all the cameras of the local area network will be discovered by Windows thanks to the UPnP function support of our cameras.

In the example below, we successfully found the camera that we had just connected to the network.

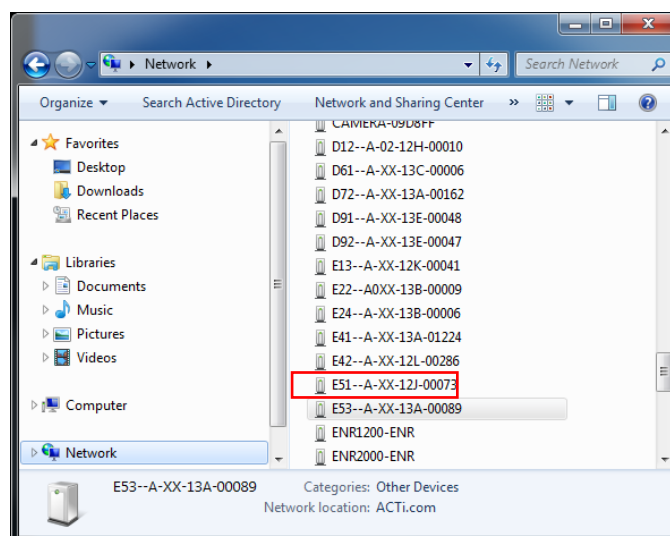

By double-clicking with the left mouse on the camera model, it is possible to automatically launch the default browser of the PC with the IP address of the target camera filled in the address bar of the browser already.

If you work with our cameras regularly, then **there is even a better way to discover the cameras in the network** – by using **IP Utility**. The IP Utility is a light software tool that can not only discover the cameras, but also list lots of valuable information, such as IP and MAC addresses, serial numbers, firmware versions, etc, and allows quick configuration of multiple devices at the same time.

The IP Utility can be downloaded for free from http://www.acti.com/IP_Utility

With just one click, you can launch the IP Utility and there will be an instant report as follows:

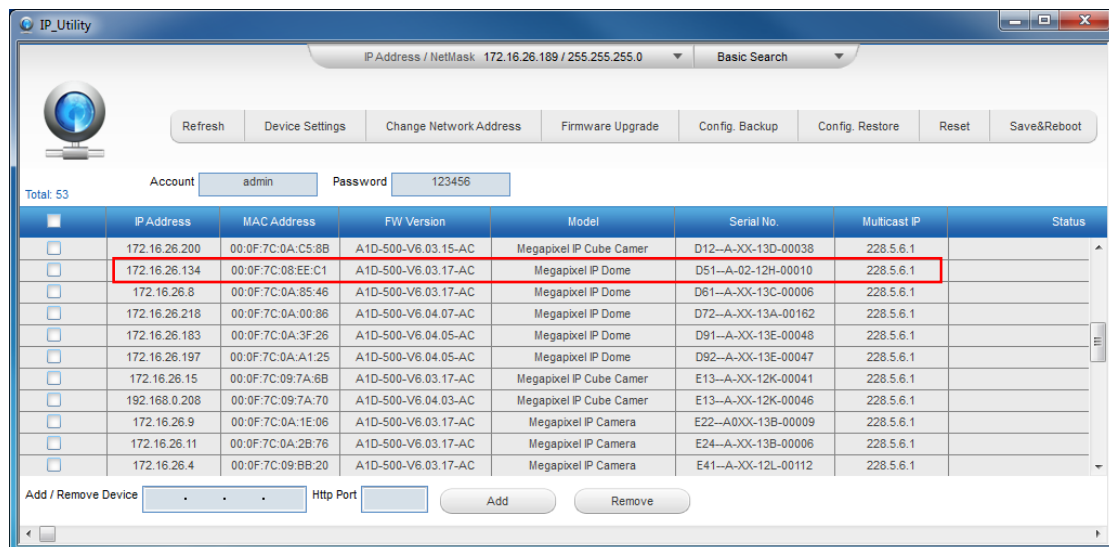

You can quickly see the camera model in the list. Click on the IP address to automatically launch the default browser of the PC with the IP address of the target camera filled in the address bar of the browser already.

Using the Default Camera IP Address

If there is no DHCP server in the given network, the user may have to assign the IP addresses to both PC and camera manually to make sure they are in the same network segment.

When the camera is plugged into network and it does not detect any DHCP services, it will automatically assign itself a default IP:

192.168.0.100

Whereas the default port number would be **80**. In order to access that camera, the IP address of the PC has to be configured to match the network segment of the camera.

Manually adjust the IP address of the PC:

In the following example, based on Windows 7, we will configure the IP address to **192.168.0.99** and set Subnet Mask to **255.255.255.0** by using the steps below:

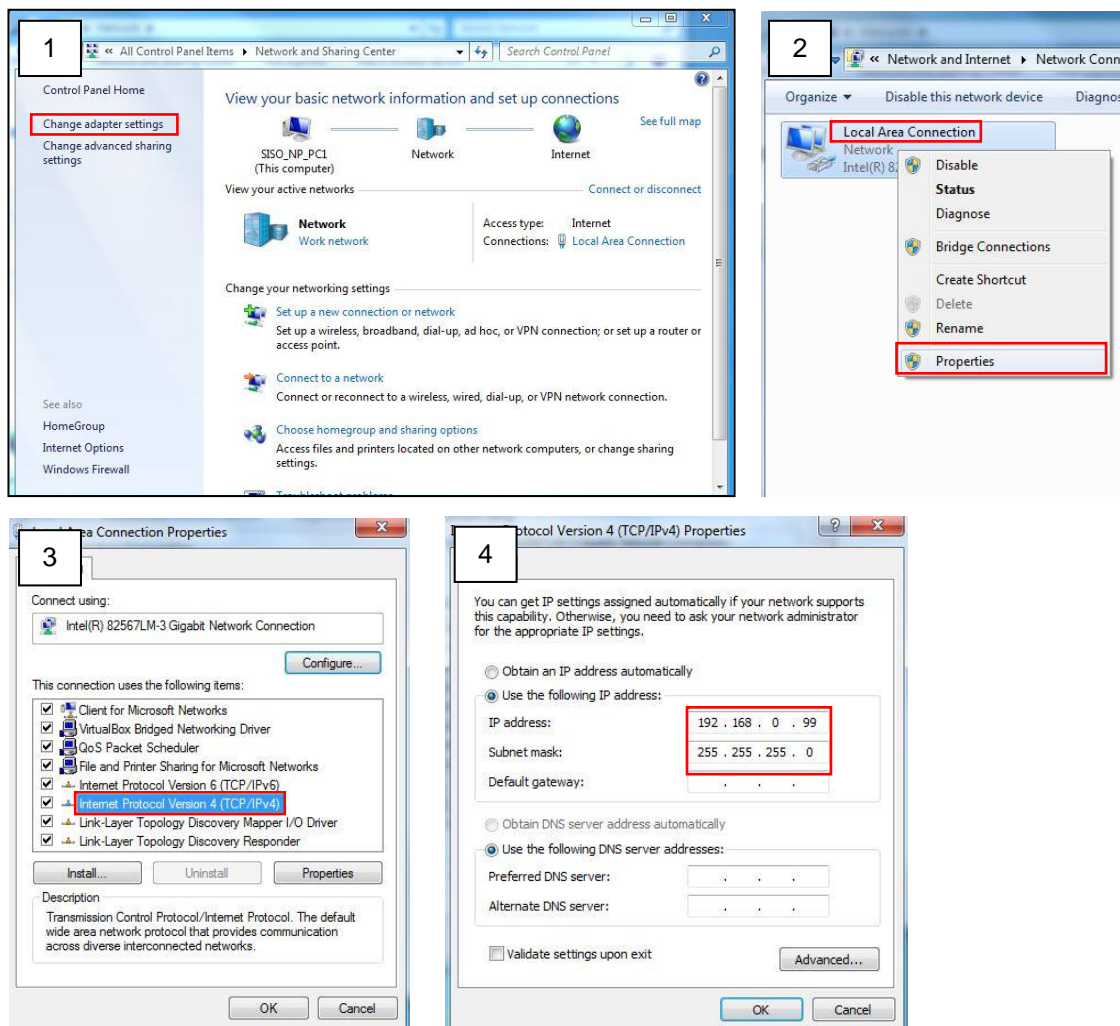

Manually adjust the IP addresses of multiple cameras:

If there are more than 1 camera to be used in the same local area network and there is no DHCP server to assign unique IP addresses to each of them, all of the cameras would then have the initial IP address of **192.168.0.100**, which is not a proper situation for network devices – all the IP addresses have to be different from each other. The easiest way to assign cameras the IP addresses is by using **IP Utility**:

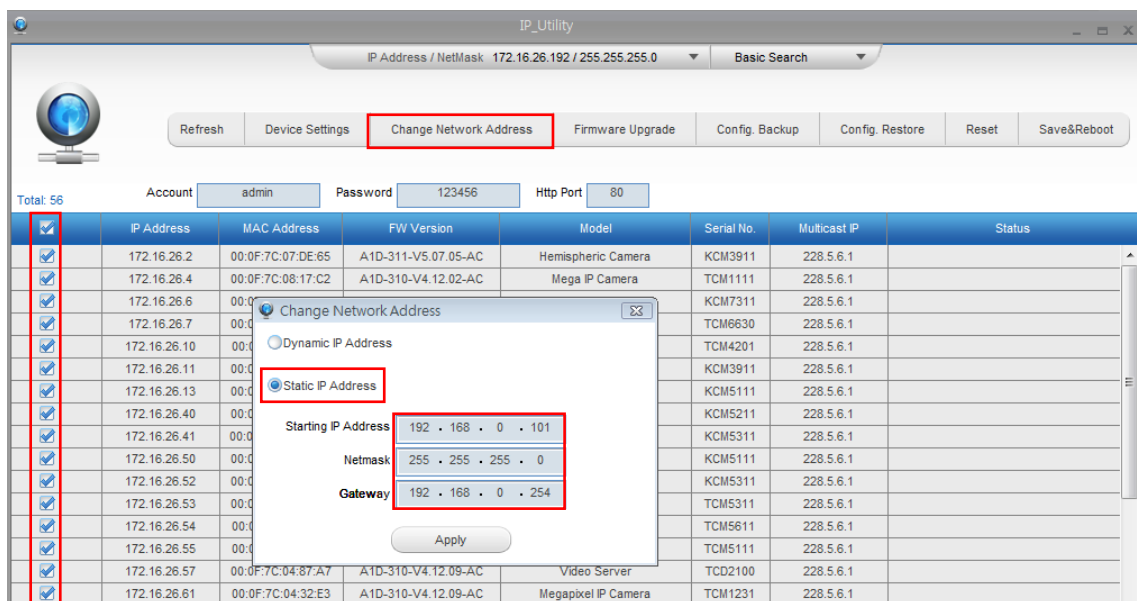

With the procedure shown above, all the cameras will have unique IP addresses, starting from 192.168.0.101. In case there are 20 cameras selected, the last one of the cameras would have the IP 192.168.0.120.

Later, by pressing the “Refresh” button of the IP Utility, you will be able to see the list of cameras with their new IP addresses.



Please note that it is also possible to change the IP addresses manually by using the Web browser. In such case, please plug in only one camera at a time, and change its IP address by using the Web browser before plugging in the next one. This way, the Web browser will not be confused about two devices having the same IP address at the same time.

Access the Camera

Now that the camera and the PC are both having their unique IP addresses and are under the same network segment, it is possible to use the Web browser of the PC to access the camera.

You can use **any of the browsers** to access the camera, however, the full functionality is provided only for **Microsoft Internet Explorer**.

The browser functionality comparison:

Functionality	Internet Explorer	Other browsers
Live Video	Yes	Yes*
Live Video Area Resizable	Yes	No
PTZ Control	Yes	Yes
Capture the snapshot	Yes	Yes
Video overlay based configuration (Motion Detection regions, Privacy Mask regions)	Yes	No
All the other configurations	Yes	Yes

* When using non-Internet Explorer browsers, free third-party software plug-ins must be installed to the PC first to be able to get the live video feed from the camera:

Browser	Required Plug-In
Safari	QuickTime (http://www.apple.com/quicktime/download/)
Other non-Internet Explorer browsers	Basic VLC Media Player (http://www.videolan.org)

***Disclaimer Notice:** The camera manufacturer does not guarantee the compatibility of its cameras with VLC player or QuickTime – since these are third party softwares. The third party has the right to modify their utility any time which might affect the compatibility. In such cases, please use Internet Explorer browser instead.*

When using Internet Explorer browser, the ActiveX control for video stream management will be downloaded from the camera directly – the user just has to accept the use of such control when prompted so. No other third party utilities are required to be installed in such case.

The following examples in this manual are based on Internet Explorer browser in order to cover all functions of the camera.

Assuming that the camera's IP address is **192.168.0.100**, you can access it by opening the Web browser and typing the following address into Web browser's address bar:

http://192.168.0.100

Upon successful connection to the camera, the user interface called **Web Configurator** would appear together with the login page. The HTTP port number was not added behind the IP address since the default HTTP port of the camera is 80, which can be omitted from the address for convenience.

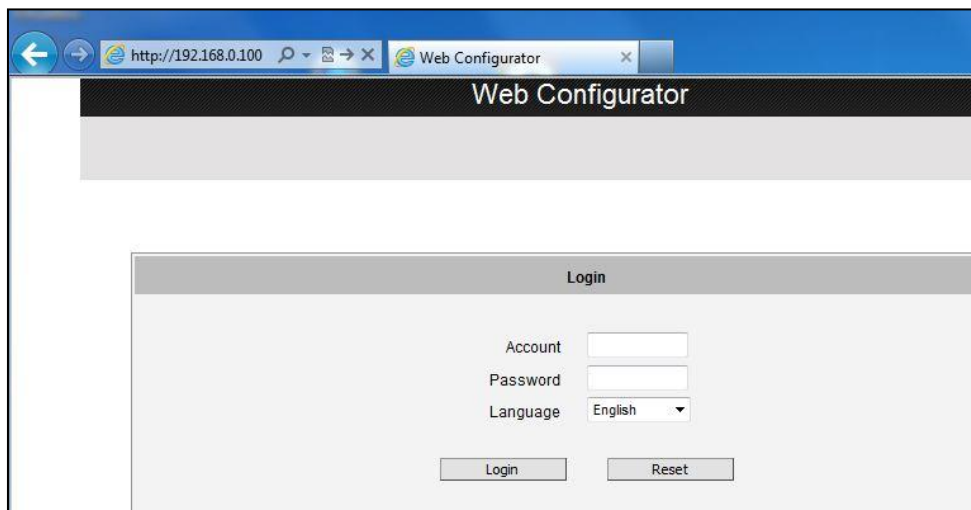

Before logging in, you need to know the factory default Account and Password of the camera.

Account: **Admin**

Password: **123456**



Copyright © 2014, ACTi Corporation All Rights Reserved

7F, No. 1, Alley 20, Lane 407, Sec. 2, Ti-Ding Blvd., Neihu District, Taipei, Taiwan 114, R.O.C.

TEL : +886-2-2656-2588 FAX : +886-2-2656-2599

Email: sales@acti.com