



Main

Product Type	Industrial Control Transformer
Power Rating	1000 VA
Type	T

Complementary

Number of Phases	1 phase
Power Rating	1000 VA UL 1000 VA CSA 1000 VA NOM 630 VA
Temperature Rise	115 °C
Electrical Connection	Screw clamp terminals
Height	4.51 in (114.55 mm)
Width	5.25 in (133.35 mm)
Depth	6.3 in (160.02 mm)
Fingersafe Cover Compatibility	FSC2

Environment

Certifications	CSA UL Listed
Enclosure Type	Not rated (open device)
Insulation Temperature	356 °F (180 °C)

Ordering and shipping details

Category	16206 - 9070 T (NOT TF) MTO
Discount Schedule	CP8
GTIN	00785901803539
Nbr. of units in pkg.	1
Package weight(Lbs)	1 lb(US) (0.45 kg)
Returnability	Yes
Country of origin	US

Packing Units

Package 1 Height	7.00 in (17.780 cm)
Package 1 width	8.30 in (21.082 cm)
Package 1 Length	9.00 in (22.860 cm)

Offer Sustainability

Sustainable offer status	Green Premium product
California proposition 65	WARNING: This product can expose you to chemicals including: Phenyl glycidyl ether, which is known to the State of California to cause cancer and birth defects or other reproductive harm. For more information go to www.P65Warnings.ca.gov
EU RoHS Directive	Compliant EU RoHS Declaration
Mercury free	Yes
RoHS exemption information	Yes
China RoHS Regulation	China RoHS Declaration
Environmental Disclosure	Product Environmental Profile
PVC free	Yes

Contractual warranty

Warranty	10 Years
----------	----------

Approximate Dimensions

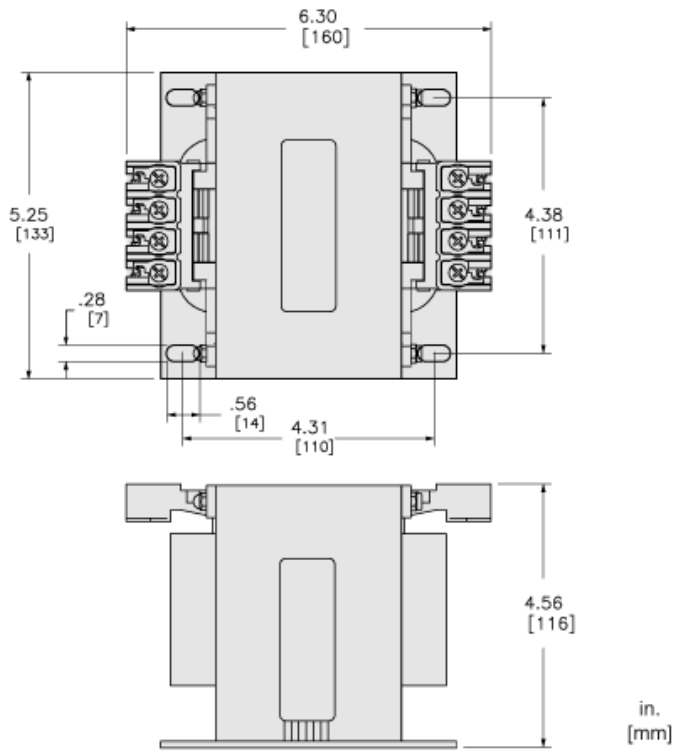

Connections and Wiring Diagrams

Voltage and Connection Options

Voltage Code	Voltages		Connections	
	Primary	Secondary	Primary	Secondary
D33	380/400/415	115/230	380: Connect to H1 and H2 400: Connect to H1 and H3 415: Connect to H1 and H4	115: Connect to X1 and X4 Jumper X1 with X3 Jumper X2 with X4 230: Connect to X1 and X4 Jumper X2 with X3
D37	550/575/600	110/220 115/230 120/240	550 or 575 or 600: Connect to H1 and H2	110 or 115 or 120: Connect to X1 and X4 Jumper X1 with X3 Jumper X2 with X4 220 or 230 or 240: Connect to X1 and X4 Jumper X2 with X3
D60	277	120/240	277: Connect to H1 and H2	120: Connect to X1 and X4 Jumper X1 with X3 Jumper X2 with X4 240: Connect to X1 and X4 Jumper X2 with X3

