



Main

Range of product	Altivar 12
Product or component type	Variable speed drive
Product destination	Asynchronous motors
Product specific application	Simple machine
Assembly style	On base plate
Component name	ATV12
Quantity per set	Set of 1
EMC filter	Integrated
Built-in fan	Without
Phase	1 phase
[Us] rated supply voltage	200...240 V - 15...10 %
Motor power kW	0.75 kW
Maximum Horse Power Rating	1 hp
Communication port protocol	Modbus
Line current	10.2 A 200 V 8.5 A 240 V
Speed range	1...20
Transient overtorque	150...170 % of nominal motor torque depending on drive rating and type of motor
Asynchronous motor control profile	Sensorless flux vector control Voltage/Frequency ratio (V/f) Quadratic voltage/frequency ratio
IP degree of protection	IP20 without blanking plate on upper part
Noise level	0 dB

Complementary

Supply frequency	50/60 Hz +/- 5 %
Connector type	1 RJ45 on front face)Modbus
Physical interface	2-wire RS 485 Modbus
Transmission frame	RTU Modbus
Transmission rate	4800 bit/s 9600 bit/s 19200 bit/s 38400 bit/s
Number of addresses	1...247 Modbus
Communication service	Read holding registers (03) 29 words Write single register (06) 29 words Write multiple registers (16) 27 words Read/Write multiple registers (23) 4/4 words Read device identification (43)
Prospective line Isc	1 kA
Continuous output current	4.2 A 4 kHz
Maximum transient current	6.3 A 60 s
Speed drive output frequency	0.5...400 Hz
Nominal switching frequency	4 kHz

The information provided in this documentation contains general descriptions and/or technical characteristics of the performance of the products contained herein. This documentation is not intended as a substitute for and is not to be used for determining suitability or reliability of these products for specific user applications. It is the duty of any such user or integrator to perform the appropriate and complete risk analysis, evaluation and testing of the products with respect to the relevant specific application or use thereof. Neither Schneider Electric Industries SAS nor any of its affiliates or subsidiaries shall be responsible or liable for misuse of the information contained herein.

Switching frequency	2...16 kHz adjustable 4...16 kHz with derating factor
Braking torque	Up to 70 % of nominal motor torque without braking resistor
Motor slip compensation	Preset in factory Adjustable
Output voltage	200...240 V 3 phases
Electrical connection	Terminal, clamping capacity: 3.5 mm ² , AWG 12 (L1, L2, L3, U, V, W, PA, PC)
Tightening torque	7.08 lbf.in (0.8 N.m)
Insulation	Electrical between power and control
Supply	Internal supply for reference potentiometer 5 V DC 4.75...5.25 V), <10 mA overload and short-circuit protection Internal supply for logic inputs 24 V DC 20.4...28.8 V), <100 mA overload and short-circuit protection
Analogue input number	1
Analogue input type	Configurable current AI1 0...20 mA 250 Ohm Configurable voltage AI1 0...10 V 30 kOhm Configurable voltage AI1 0...5 V 30 kOhm
Discrete input number	4
Discrete input type	Programmable LI1...LI4 24 V 18...30 V
Discrete input logic	Negative logic (sink), > 16 V, < 10 V 3.5 kOhm Positive logic (source), 0...< 5 V (state 0), > 11 V (state 1)
Sampling duration	20 Ms +/- 1 ms logic input 10 ms analogue input
Linearity error	+/- 0.3 % of maximum value analogue input
Analogue output number	1
Analogue output type	AO1 software-configurable voltage 0...10 V 470 Ohm 8 bits AO1 software-configurable current 0...20 mA 800 Ohm 8 bits
Discrete output number	2
Discrete output type	Logic output LO+, LO- Protected relay output R1A, R1B, R1C 1 C/O
Minimum switching current	5 mA 24 V DC logic relay
Maximum switching current	2 A 250 V AC inductive cos phi = 0.4 L/R = 7 ms logic relay 2 A 30 V DC inductive cos phi = 0.4 L/R = 7 ms logic relay 3 A 250 V AC resistive cos phi = 1 L/R = 0 ms logic relay 4 A 30 V DC resistive cos phi = 1 L/R = 0 ms logic relay
Acceleration and deceleration ramps	S U Linear from 0 to 999.9 s
Braking to standstill	By DC injection, <30 s
Protection type	Line supply overvoltage Line supply undervoltage Overcurrent between output phases and earth Overheating protection Short-circuit between motor phases Against input phase loss in three-phase Thermal motor protection via the drive by continuous calculation of I ² t
Frequency resolution	Analog input converter A/D, 10 bits Display unit: 0.1 Hz
Time constant	20 ms +/- 1 ms for reference change
Marking	CE
Operating position	Vertical +/- 10 degree
Height	5.63 in (143 mm)
Width	2.83 in (72 mm)
Depth	4.02 in (102.2 mm)
Net Weight	1.54 lb(US) (0.7 kg)
Variable speed drive application selection	Commercial equipment Mixer Commercial equipment Other application Textile Ironing
Motor starter type	Variable speed drive

Environment

Electromagnetic compatibility	Electrical fast transient/burst immunity test level 4 conforming to EN/IEC 61000-4-4 Electrostatic discharge immunity test level 3 conforming to EN/IEC 61000-4-2 Immunity to conducted disturbances level 3 EN/IEC 61000-4-6 Radiated radio-frequency electromagnetic field immunity test level 3 conforming to EN/IEC 61000-4-3 Surge immunity test level 3 conforming to EN/IEC 61000-4-5 Voltage dips and interruptions immunity test conforming to EN/IEC 61000-4-11
Electromagnetic emission	Radiated emissions environment 1 category C2 conforming to EN/IEC 61800-3 2...16 kHz shielded motor cable Conducted emissions with integrated EMC filter environment 1 category C1 conforming to EN/IEC 61800-3 2, 4, 8, 12 and 16 kHz shielded motor cable <5 m Conducted emissions with integrated EMC filter environment 1 category C2 conforming to EN/IEC 61800-3 2...12 kHz shielded motor cable <5 m Conducted emissions with integrated EMC filter environment 1 category C2 conforming to EN/IEC 61800-3 2, 4 and 16 kHz shielded motor cable <10 m Conducted emissions with additional EMC filter environment 1 category C1 conforming to EN/IEC 61800-3 4...12 kHz shielded motor cable <20 m Conducted emissions with additional EMC filter environment 1 category C2 conforming to EN/IEC 61800-3 4...12 kHz shielded motor cable <50 m Conducted emissions with additional EMC filter environment 2 category C3 conforming to EN/IEC 61800-3 4...12 kHz shielded motor cable <50 m
Product certifications	C-tick CSA NOM GOST UL
Vibration resistance	1 gn 13...200 Hz)EN/IEC 60068-2-6 1.5 mm peak to peak 3...13 Hz) - drive unmounted on symmetrical DIN rail - EN/IEC 60068-2-6
Shock resistance	15 gn 11 ms EN/IEC 60068-2-27
Relative humidity	5...95 % without condensation IEC 60068-2-3 5...95 % without dripping water IEC 60068-2-3
Ambient air temperature for storage	-13...158 °F (-25...70 °C)
Ambient air temperature for operation	14...104 °F (-10...40 °C) protective cover from the top of the drive removed 104...140 °F (40...60 °C) with current derating 2.2 % per °C
Operating altitude	> 1000...2000 m with current derating 1 % per 100 m <= 3280.84 ft (1000 m) without derating

Ordering and shipping details

Category	22042 - ATV12 DRIVE AND ACCESSORIES
Discount Schedule	CP4B
GTIN	00785901978183
Nbr. of units in pkg.	1
Package weight(Lbs)	2.17 lb(US) (0.98 kg)
Returnability	Yes
Country of origin	ID

Packing Units

Unit Type of Package 1	PCE
Package 1 Height	4.72 in (12 cm)
Package 1 width	7.36 in (18.7 cm)
Package 1 Length	7.68 in (19.5 cm)
Unit Type of Package 2	P06
Number of Units in Package 2	45
Package 2 Weight	122.91 lb(US) (55.75 kg)
Package 2 Height	31.50 in (80 cm)
Package 2 width	31.50 in (80 cm)
Package 2 Length	23.62 in (60 cm)

Offer Sustainability

Sustainable offer status	Green Premium product
California proposition 65	WARNING: This product can expose you to chemicals including: Lead and lead compounds, which is known to the State of California to cause cancer and birth defects or other reproductive harm. For more information go to www.P65Warnings.ca.gov
EU RoHS Directive	Pro-active compliance (Product out of EU RoHS legal scope) EU RoHS Declaration
Mercury free	Yes
RoHS exemption information	Yes
China RoHS Regulation	China RoHS Declaration
Environmental Disclosure	Product Environmental Profile
Circularity Profile	End Of Life Information
WEEE	The product must be disposed on European Union markets following specific waste collection and never end up in rubbish bins.

Contractual warranty

Warranty	18 months
----------	-----------

Dimensions

Drive without EMC Conformity Kit

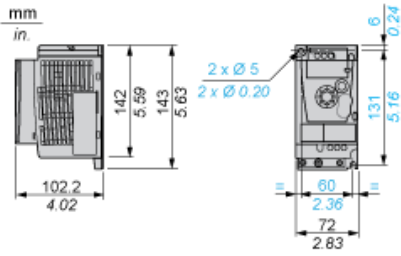

Drive with EMC Conformity Kit

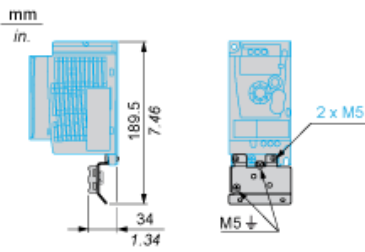

Mounting Recommendations

Clearance for Vertical Mounting



Mounting Type A

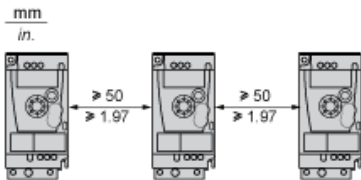

Mounting Type B

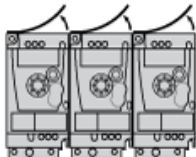

Remove the protective cover from the top of the drive.

Mounting Type C

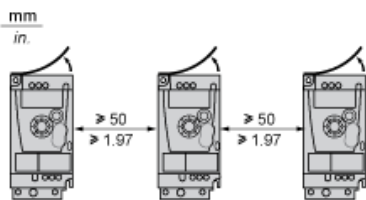

Remove the protective cover from the top of the drive.

Single-Phase Power Supply Wiring Diagram

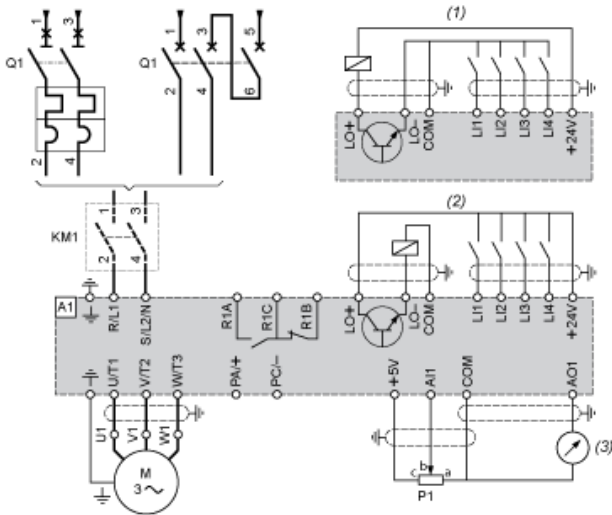

- A1 Drive
- KM1 Contactor (only if a control circuit is needed)
- P1 2.2 kΩ reference potentiometer. This can be replaced by a 10 kΩ potentiometer (maximum).
- Q1 Circuit breaker
- (1) Negative logic (Sink)
- (2) Positive logic (Source) (factory set configuration)
- (3) 0...10 V or 0...20 mA

Recommended Schemes

2-Wire Control for Logic I/O with Internal Power Supply

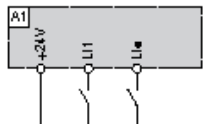

- L1: Forward
- L1•: Reverse
- A1: Drive

3-Wire Control for Logic I/O with Internal Power Supply



- L1: Stop
- L12: Forward
- L1•: Reverse
- A1: Drive

Analog Input Configured for Voltage with Internal Power Supply



- (1) 2.2 k Ω ...10 k Ω reference potentiometer
A1 : Drive

Analog Input Configured for Current with Internal Power Supply



- (2) 0-20 mA 4-20 mA supply
A1 : Drive

Connected as Positive Logic (Source) with External 24 vdc Supply



- (1) 24 vdc supply
A1 : Drive

Connected as Negative Logic (Sink) with External 24 vdc supply



- (1) 24 vdc supply
A1 : Drive

Torque Curves



- 1 : Self-cooled motor: continuous useful torque (1)
- 2 : Force-cooled motor: continuous useful torque
- 3 : Transient overtorque for 60 s
- 4 : Transient overtorque for 2 s
- 5 : Torque in overspeed at constant power (2)

(1) For power ratings ≤ 250 W, derating is 20% instead of 50% at very low frequencies.

(2) The nominal motor frequency and the maximum output frequency can be adjusted from 0.5 to 400 Hz. The mechanical overspeed capability of the selected motor must be checked with the manufacturer.