



REGISTER YOUR PRODUCT ONLINE

at championpowerequipment.com



or visit championpowerequipment.com

READ AND SAVE THIS MANUAL. This manual contains important safety precautions which should be read and understood before operating the product. Failure to do so could result in serious injury. This manual should remain with the product.

Specifications, descriptions and illustrations in this manual are as accurate as known at the time of publication, but are subject to change without notice.

TABLE OF CONTENTS

Introduction	3	Maintenance	23
Safety Definitions	3	Cleaning the Power Station	23
Important Safety Instructions	4	Storage	23
Lithium-ion Battery Safety	5	Specifications	24
Safety and Dataplate Labels	8	Power Station Specifications	24
Safety Symbols	9	Battery Specifications	24
Operation Symbols	11	AC Charger Specifications	24
Controls and Features	12	Solar Charge Specifications	24
Power Station	12	Automotive Charge Specifications	24
Control Panel	13	Temperature Specifications	24
Intelligauge	14	Troubleshooting	25
FCC Statement	17	Power Station Fault Indicator Codes	27
Industry Canada: ICES-003/NMB-003	17		
Parts Included	17		
Parts Not Included	17		
Initial Use	18		
Unpacking	18		
Grounding	18		
Surge Protection	18		
Charging from Wall	18		
Using Included Solar Charge Cable	19		
Recommended Solar Panels	19		
Using 12V DC Automotive Charge Cable	20		
Operation	20		
Using the Power Station	20		
Using the Wireless Charging Pad	20		
Standby Mode	21		
LED Light	21		
Connecting Electrical Loads	21		
Resetting the Output	22		
Do Not Overload Power Station	22		
Operation at High Altitude	23		
Turning Off the Power Station	23		
Moving the Power Station	23		

 **FOR PARTS BREAKDOWN**

Search by model number at
championpowerequipment.com

INTRODUCTION

Congratulations on your purchase of a Champion Power Equipment (CPE) product. CPE designs, builds, and supports all of our products to strict specifications and guidelines. With proper product knowledge, safe use, and regular maintenance, this product should bring years of satisfying service.

Every effort has been made to ensure the accuracy and completeness of the information in this manual at the time of publication, and we reserve the right to change, alter and/or improve the product and this document at any time without prior notice.

CPE highly values how our products are designed, manufactured, operated, and serviced as well as providing safety to the operator and those around the Power Station. Therefore, it is **IMPORTANT** to review this product manual and other product materials thoroughly and be fully aware and knowledgeable of the assembly, operation, dangers and maintenance of the product before use. Fully familiarize yourself, and make sure others who plan on operating the product fully familiarize themselves too, with the proper safety and operation procedures before each use. Please always exercise common sense and always err on the side of caution when operating the product to ensure no accident, property damage, or injury occurs. We want you to continue to use and be satisfied with your CPE product for years to come.

When contacting CPE about parts and/or service, you will need to supply the complete model and serial numbers of your product. Transcribe the information found on your product's nameplate label to the table below

CPE TECHNICAL SUPPORT TEAM
1-877-338-0999
MODEL NUMBER
201189
SERIAL NUMBER
DATE OF PURCHASE
PURCHASE LOCATION

SAFETY DEFINITIONS

The purpose of safety symbols is to attract your attention to possible dangers. The safety symbols, and their explanations, deserve your careful attention and understanding. The safety warnings do not by themselves eliminate any danger. The instructions or warnings they give are not substitutes for proper accident prevention measures.

DANGER

DANGER indicates a hazardous situation which, if not avoided, will result in death or serious injury.

WARNING

WARNING indicates a hazardous situation which, if not avoided, could result in death or serious injury.

CAUTION

CAUTION indicates a hazardous situation which, if not avoided, could result in minor or moderate injury.

NOTICE

NOTICE indicates information considered important, but not hazard-related (e.g., messages relating to property damage).

IMPORTANT SAFETY INSTRUCTIONS

⚠ WARNING

Cancer and Reproductive Harm – www.P65Warnings.ca.gov

⚠ WARNING

Read all safety warnings and instructions. Failure to follow warnings and instruction may result in electric shock, fire and/or cause serious personal injury. Save all warnings and instruction.

⚠ DANGER

Power Station generates powerful voltage.

Keep your Power Station in a dry, well-ventilated area when in use.

Do not operate the Power Station with a damaged cord, plug, or a damaged output cable. Use only Champion electrical cords for proper application.

Do not allow children or unqualified persons to operate or service the Power Station.

Do not operate Power Station in wet conditions. To avoid short circuits or electric shock do not allow unit to get wet. In the event the unit does get wet, let the unit dry completely before using.

Always use a ground fault circuit interrupter (GFCI) while charging in damp areas and areas containing conductive material such as metal decking.

Do not allow fluids to flow into Power Station. Corrosive or conductive fluids, such as seawater, industrial chemicals, bleach or bleach containing products can cause a short circuit, damaging the Power Station and voiding the warranty.

This equipment has internal arcing or sparking parts which should not be exposed to flammable vapors or liquids.

⚠ WARNING

To avoid fire or electrical shock hazard, observe all ratings on the Power Station and accessory products you intend to use.

⚠ DANGER

This device is intended to be used indoors only. Do not use outdoors.

⚠ WARNING

Do not use Power Station for medical life support uses.

In case of emergency, call 911 immediately.

NEVER use this product to power life support devices or life support appliances.

Inform your electricity provider immediately if you or anyone in your household depends on electrical medical equipment to live.

Inform your electrical provider immediately if a loss of power would cause you or anyone in your household to experience a medical emergency.

⚠ WARNING

Power Station produces heat.

Do not touch hot surfaces.

Allow equipment to cool before touching.

⚠ WARNING

Exceeding the Power Station's running capacity can damage the Power Station and/or electrical devices connected to it.

DO NOT overload the Power Station.

DO NOT tamper or modify the Power Station in any way.

⚠ WARNING

Improper treatment or use of the Power Station can damage it, shorten its life and void the warranty.

Use the Power Station only for intended uses.

DO NOT expose Power Station to moisture, dust, or dirt.

DO NOT allow any material to block the cooling slots.

If connected devices overheat, turn them off and disconnect them from the Power Station.

DO NOT use the Power Station if:

- Electrical output is lost
- Equipment sparks, smokes or emits flames
- Equipment vibrates excessively

Lithium-ion Battery Safety

⚠ DANGER

Electrolyte inside the battery is harmful to skin and eyes. Electrolyte may pose an increased risk of harm if not handled properly.

Under abusive conditions, liquid may be ejected from the battery; avoid contact. Liquid ejected from the battery may cause irritation or burns. If contact accidentally occurs, flush with water. If the battery leaks and electrolyte gets in your eyes, do not rub them, immediately flood eye with running cold water for at least 10 minutes and seek medical help. If left untreated, electrolyte can cause permanent eye injury. Keep away from children.

⚠ DANGER

This Power Station generates the same potential lethal AC electrical voltage as a standard building wall outlet.

Always treat the Power Station as you would a normal AC outlet on a standard building wall.

⚠ WARNING

When using the Power Station:

- Always use in a dry well ventilated area while in use and do not obstruct fan openings on unit. Inadequate ventilation may cause excessive heat and damage the unit.
- Always keep the unit clean and dry and inspect for dirt, dust, or moisture prior to every use.
- Power cord plugs must always match the outlet. Never modify the plug in any way. Do not use any adapter plugs with earthed (grounded) power tools.
- Connect only to properly grounded outlets.
- To reduce risk of damage to the electric plug and cord, pull the plug rather than the cord when disconnecting the Power Station. Never use the cord for carrying, pulling or unplugging the tool.
- Do not use this Power Station if the power cord or the battery cables are damaged in any way.
- Always use a suitable extension cord to reduce the risk of electric shock.
- Always keep the cord away from heat, oil, sharp edges or moving parts.
- Always position cords carefully to avoid hazardous conditions. Tripping or snagging on cords can cause injury or cause product damage. Never allow cords to run through puddles or across wet ground.
- Use of an accessory attachment not recommended or sold by Champion Power Equipment may result in a risk of fire, electric shock, or injury to persons.
- To reduce the risk of electric shock always unplug the cord from outlet when not in use and before servicing or cleaning.
- Do not insert foreign objects into outputs or ventilation holes.

⚠ WARNING

- Do not overload the Power Station's capacity. Exceeding the wattage/amperage capacity may damage the power supply and/or electrical devices connected to it. Inductive loads such as refrigerators with compressors, motor powered equipment, and air conditioners may have much greater starting wattage than their rated wattage.
- Do not connect Power Station output to a building's electrical system.
- Do not use this unit if you do not understand these operating instructions.
- Maintain the labels and nameplates on this Power Station. These carry important information.

⚠ WARNING

- Do not use a Power Station or appliance that is damaged or modified. Damaged or modified internal batteries may exhibit unpredictable behavior resulting in fire, explosion or risk of injury.
- Do not remove cover. No user serviceable parts inside.
- Do not tamper or disassemble the Power Station to attempt service or replace the battery. Incorrect reassembly may result in a risk of fire, electric shock or personal injury.
- For service information please contact our Champion Technical Support Team at 1-877-338-0999. Please have your serial number and model number available when service, repair or replacement is required.
- Never place fingers or hands inside the product.

⚠ WARNING

- To reduce the risk of injury or damage, avoid contact with any hot surface.
- Do not use the Power Station near sources of high heat or fire. Exposure to fire or temperature above 265°F (130°C) may cause explosion.
- Do not discharge the Power Station battery in temperatures below 5°F (-15°C) or above 104°F (40°C).
- Do not allow fluids to flow into the Power Station. Corrosive or conductive fluids, such as seawater, certain industrial chemicals, and bleach or bleach containing products, etc., can cause a short circuit.
- Follow all charging instructions and do not charge the Power Station outside the temperature range specified in the instructions. Charging improperly or at temperatures outside the specified range may damage the battery and increase the risk of fire.

When charging the Power Station:

- Always charge the Power Station's internal battery in a well-ventilated area.
- Do not use the AC charging cable outdoors.
- Do not expose AC charging cable to oil, oil vapor, grease, gasoline, gasoline vapors or other caustic substances that may damage the AC charging cable.
- Do not charge the Power Station below 43°F (6°C) or above 104°F (40°C).
- Do not charge Power Station in rain, snow, damp or wet locations.
- Do not overcharge the Power Station. Use only supplied AC charging cable and follow solar charging guidelines and voltage and current limits.
- Always connect to properly grounded outlets.
- Never use Power Station or charger in the presence of explosive atmospheres (gaseous fumes, dust or flammable materials).
- Never leave the Power Station unattended while charging. If the internal battery smokes, or gives off an odor during charging, terminate charging immediately.
- During charging, if the Power Station battery becomes hot to the touch, stop charging. Allow Power Station to cool before resuming.
- Always unplug charger when not in use.
- To reduce the risk of electric shock, always unplug charger before cleaning or maintenance. Do not allow water to flow into plug. Use a Ground Fault Circuit Interrupter (GFCI) to reduce shock hazards.

Grounding Information:

If the Power Station should malfunction or breakdown, provides a path of least resistance for electric current to reduce the risk of electric shock. This product is equipped with a cord having an equipment conductor and a plug. The plug must be plugged into an outlet that is properly installed and grounded in accordance with all local codes ordinances. We strongly recommend that you consult with a qualified electrician to ensure compliance with local electrical codes.

When storing the Power Station:

- This Power Station is intended to be stored indoors and shall not be stored or left outdoors when not in use.
- Do not stack any items on top of the Power Station during storage.
- Store your Power Station in a cool, dry place between 32°F (0°C) and 104°F (40°C). The ideal storage temperature is 59°F (15°C).

- Do not store Power Station where temperatures may exceed 104°F (40°C) such as in direct sunlight, in a vehicle or metal buildings especially during the summer.
- Do not store the Power Station near sources of high heat or fire.
- Do not store the Power Station when battery level is at 20% or less state of charge (SOC). The ideal storage SOC is 40-60%.
- When storing the Power Station for periods of one month or longer, store the Power Station at an SOC of about 60%. Every three months, discharge the Power Station to 0% and recharge back to 100%, then discharge it to 60%.
- Lithium batteries must be charged regularly to perform well. The Power Station must be fully charged by you at least once every 6 months (180 days).

In case of battery damage:

- If damaged, the internal battery may emit hazardous fumes. If fumes are present, move Power Station to a well-ventilated area.
- Do not try to repair the Power Station or replace the battery.

Safe disposal of Lithium-ion battery:

- Lithium-ion batteries contain elements that pose health risks to individuals if they are allowed to leach into the ground water supply. In many states and counties, it may be illegal to dispose of these batteries in standard household waste.
- To dispose the battery safely, apply tape over any exposed connectors to prevent accidental shorting of the positive and negative terminals of the battery during transport.
- Place the battery in a clear sturdy plastic bag, seal the bag and deposit the battery into the recycling container at your local municipal hazardous waste (HHW) recycling location.
- In the United States and Canada, a large network of over 30,000 battery drop-off locations may be found at www.call2recycle.org.
- Never dispose of the battery in a fire or incinerator, as the battery may catch fire and explode.

Safety and Dataplate Labels

These labels warn you of potential hazards that can cause serious injury. Read them carefully.

If a label comes off or becomes hard to read, contact Technical Support Team for possible replacement.

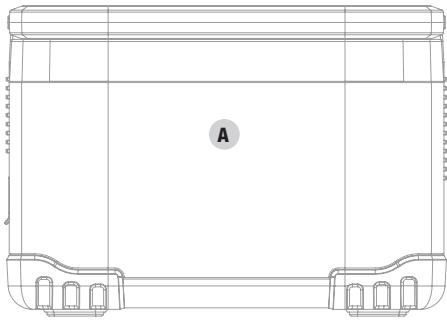

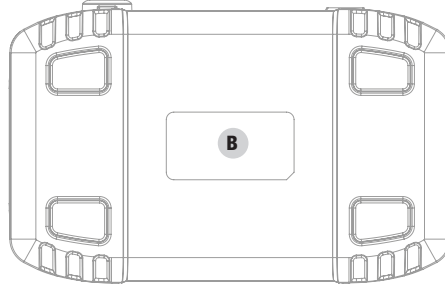

Back

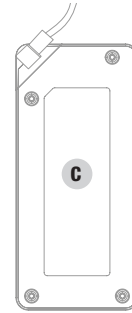

Bottom



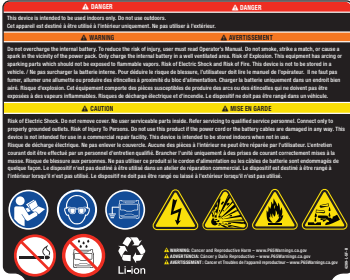
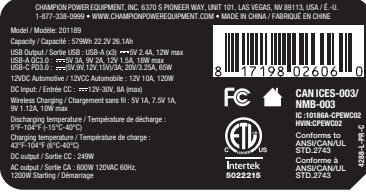







Bottom of Adapter

	LABEL	DESCRIPTION
A		Safety Symbols/ Safety Warning
B		Power Station Dataplate
C		Charging Adapter Dataplate

Safety Symbols





Some of the following symbols may be used on this product. Please study them and learn their meaning. Proper interpretation of these symbols will allow you to more safely operate the product.





SYMBOL	MEANING
	Read Operator's Manual. To reduce the risk of injury, user must read and understand operator's manual before using this product.
	Eye protection. Always wear eye protection with side shields marked to comply with ANSI Z87.1.
	Ground. Consult with local electrician to determine grounding requirements before operation.
	Electric Shock. Failure to use in dry conditions and to observe safe practices can result in electric shock.
	Shield eyes. Explosive gases can cause blindness or injury. If damaged, battery may emit hazardous fumes. If fumes present, move battery to a well-ventilated area.
	Fire/Explosion. Batteries and its vapors are extremely flammable and explosive. Fire or explosion can cause severe burns or death. Keep Power Station at least 5 feet (1.5m) from all objects to prevent combustion.
	Blindness or severe burns. Electrolyte solution can cause blindness or severe burns.
	Open Flame Alert. Keep away from fuel, smoking, open flames, sparks, pilot lights, heat, and other ignition sources.

SYMBOL	MEANING
	<p>Wet Conditions Alert. Do not operate Power Station in wet conditions.</p>
 Li-ion	<p>This product uses lithium-ion (Li-ion) batteries. Local, state, or federal laws prohibit disposal of Li-ion batteries in ordinary trash. In the United States and Canada, a large network of over 30,000 battery drop-off locations may be found at www.call2recycle.org and/or consult your local waste authority for information regarding available recycling disposal options.</p>

Operation Symbols

Some of the following symbols may be used on this product. Please study them and learn their meaning. Proper interpretation of these symbols will allow you to more safely operate the product.

SYMBOL	MEANING
	Hold for 3 seconds to power ON/OFF
	Wireless Charging Pad
USB	USB Output Button
	AC Output Button
	DC Output Button
	Charging Input Port

SYMBOL	MEANING
	USB Fast Charge Port
	USB-C PD Port
	Qualcomm Quick Charge 3+
	Pure Sine Wave Output
	LED Light Button

CONTROLS AND FEATURES

Read this operator's manual before operating your Power Station. Familiarize yourself with the location and function of the controls and features. Save this manual for future reference.

Power Station

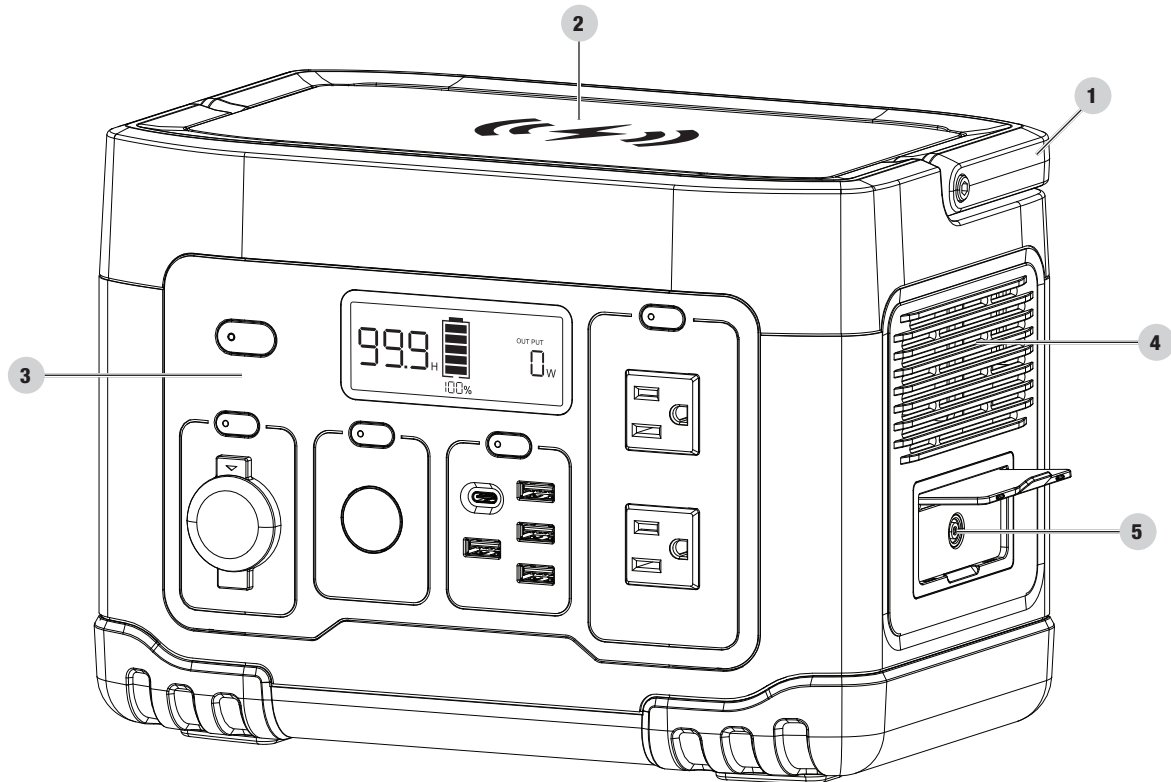

1. **Carrying Handle** – Used to lift or carry the unit.
2. **Wireless Charging Pad (5V 1A, 7.5V 1A, 9V 1.12A, 10W max.)**– Used to charge compatible devices when placed in center of pad and USB ports turned ON.
3. **Control Panel** – See *Control Panel* section.
4. **Cooling Vents** – Used to cool battery and other internal components. Do not block.
5. **Charging Port - 12-30V DC, max. 8A/200W** – Used to charge the power station via supplied accessories.

Control Panel

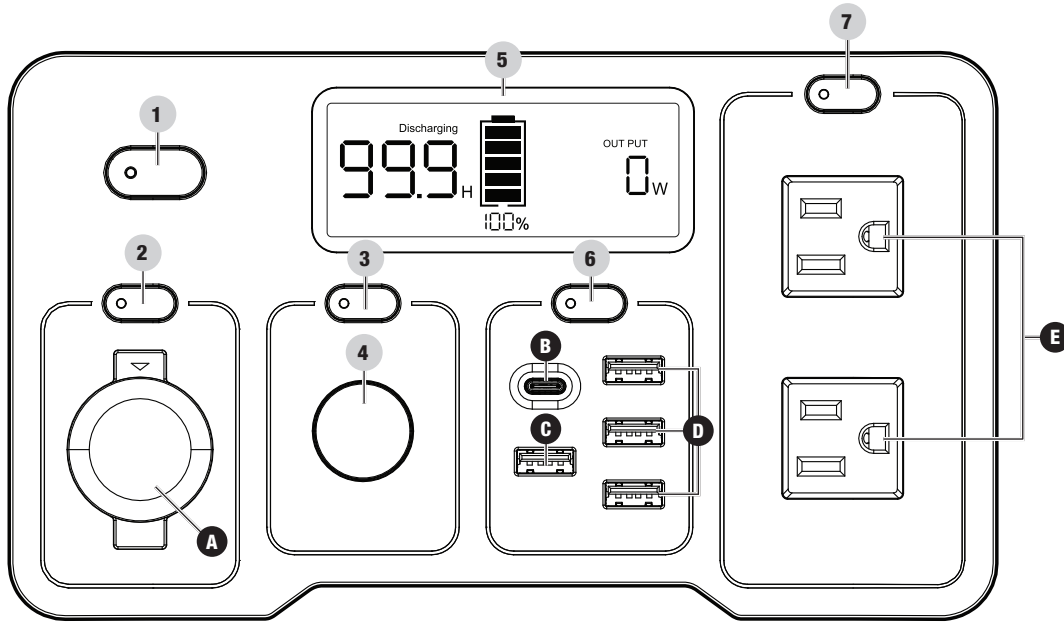

1. **On/Off Button** – Turns the Power Station ON/OFF when pressed for three seconds.
2. **12V DC Button** – Turns the 12V DC port ON/OFF when pressed one time.
3. **LED Light Button** – Used to turn the LED light ON/OFF and toggle through different modes.
4. **LED Light** – Used to illuminate the work area in front of the Power Station.
5. **Intelligauge** – See *Intelligauge* section.
6. **USB Button** – Turns the USB ports ON/OFF when pressed one time.
7. **AC Button** – Turns the AC outlet ON/OFF when pressed one time.

RECEPTACLES		
A		12V DC/10A, 120W. (12V DC Regulated Automotive) May be used to supply electrical power for operation of 12 Volt DC, 10 Amp electrical loads.
B		(5V, 9V, 12V, 15V)/3A; 20V/3.25A, 65W max. (USB-C PD3.0) Port may be used to supply DC power to cellphones, laptops, tablets, and similar devices up to a maximum of 65W with PD 3.0 compatible devices.
C		5V/3A, 9V/2A, 12V/1.5A, 18W max. (USB-A QC3.0) Port may be used to supply DC power to cellphones, laptops, tablets, and similar devices up to a maximum of 18W with Quick Charge 3.0(QC 3.0) compatible devices.
D		(3x) 5V/2.4A, 12W max. (USB-A) Ports may be used to supply DC power to cellphones, laptops, tablets, and similar devices up to a maximum of 12W.
E		(2x) 120V AC, 5.0A (NEMA 5-15R) May be used to supply electrical power for operation of 120 Volt AC, 5.0 Amp, single phase, 60 Hz electrical loads.

Intelligauge

This meter displays a variety of info such as input/output power, charge/discharge times, as well as faults, errors, and protection codes to help diagnose malfunctions in the Power Station.

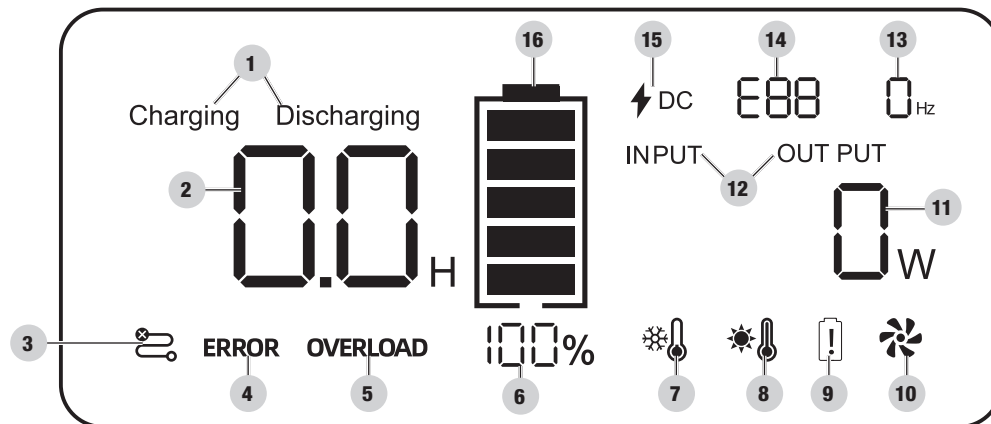

1. **Charging/Discharging** – Shows “Charging” when input watts are higher than output watts. Shows “Discharging” when output watts are higher than input watts.
2. **Hour Meter** – Shows time, in hours, until battery level is 0% (when “Discharging” shown) or hours until 100% charged (when “Charging” shown).
3. **Communication Fault** – Indicates a communication fault between the Battery Management System (BMS) or other component.
4. **Error** – Indicates a fault and may be accompanied by a Fault Indicator Code (see #14. Fault Indicator Code).
5. **Overload** – Indicates the devices’ power demands exceed the max wattage of the ports/outlets.
6. **Battery Percentage (%)** – Shows battery level in percent.
7. **Low Temperature** – Indicates internal temperature too low.
8. **High Temperature** – Indicates internal temperature too high.
9. **Battery Fault** – Indicates a battery fault and may be accompanied by a Fault Indicator Code (see #14. Fault Indicator Code).
10. **Cooling Fan** – Indicates the fan is on to cool internal components. Intermittent operation of the fan is normal.
11. **Power Meter** – Shows power, in watts, supplied to load (when “OUTPUT” shown) or supplied to charge the Power Station (when “INPUT” shown).
12. **INPUT/OUTPUT** – Toggles automatically to show input and output watts.
13. **Frequency** – Shows the frequency, in Hertz (Hz), of the AC outlet load.
14. **Fault Indicator Code** – Shows error code. See Troubleshooting section *POWER STATION FAULT INDICATOR CODES*.
15. **DC Input** – Indicates the power station is being charged. Even when charging through wall outlet, DC Input icon is illuminated as the AC power is being converted to DC to charge the battery.
16. **Fuel Gauge** – Shows battery level in 20% increments.

Display Modes and Indicators

See *Power Station Fault Indicator Codes* section for full list of codes.

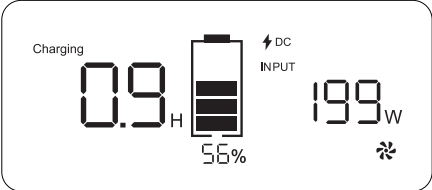
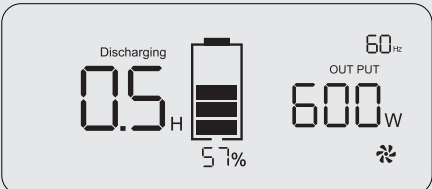
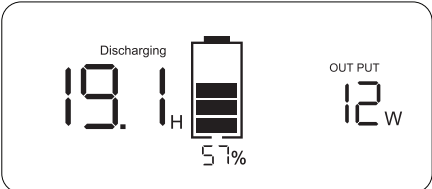
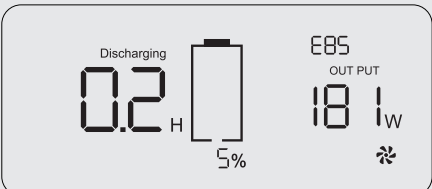
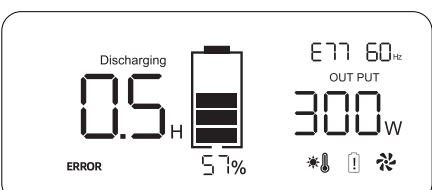
MODE	DESCRIPTION	
Charging	Example: 0.9 Hours to charge to full, 199 watts in, battery is at 56%, Fan is ON.	
Discharging (AC)	Example: 0.5 Hours to empty, 600 watts out, battery is at 57%, Fan is ON.	
Discharging (DC)	Example: 19.1 Hours to empty, 12 watts out, battery is at 57%.	
AC Voltage Protection (Low Battery)	Example: E85 Error code displayed. AC Output cutoff when battery falls to 5%. Fault will clear when charged to 7%.	
High Temperature Warning (E77)	Example: The battery surface temperature $\geq 60^\circ\text{C}$, reduce AC load, move to cooler or shaded location.	

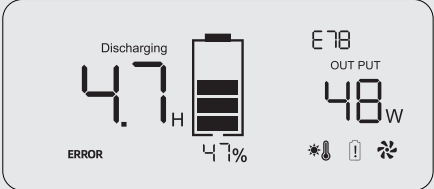
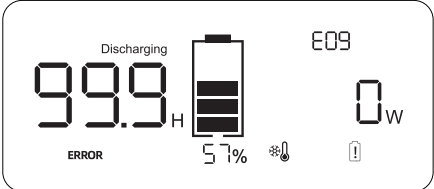
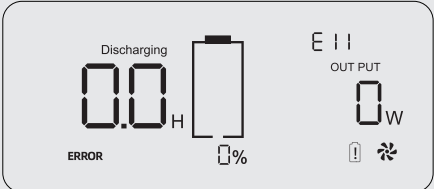
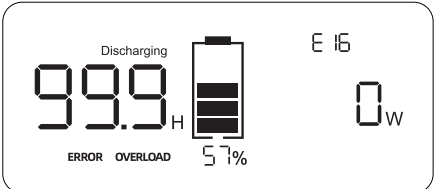
MODE	DESCRIPTION	
<p>High Temperature Protection (E78)</p>	<p>Example: The battery surface temperature $\geq 64^{\circ}\text{C}$, the AC and 12V DC will be closed automatically, the USB & PD port goes on working. Move the power station to cooler or shaded location.</p>	
<p>Low Temperature Warning</p>	<p>Example: Illuminated when the Power Station has experienced a low temperature event.</p>	
<p>Low Voltage Protection Alarm (E11)</p>	<p>Example: Battery fully discharged, power station needs to be recharged immediately.</p>	
<p>Overload</p>	<p>Example: Rated output exceeded. Reduce output, press the USB, 12V DC, or AC button to reset output.</p>	

FCC Statement

1. This device complies with Part 15 of the FCC Rules. Operation is subject to the following two conditions:
 - 1a. This device may not cause harmful interference.
 - 1b. This device must accept any interference received, including interference that may cause undesired operation.
2. Changes or modifications not expressly approved by the party responsible for compliance could void the user’s authority to operate the equipment.

▲ NOTICE

This equipment has been tested and found to comply with the limits for a Class B digital device, pursuant to Part 15 of the FCC Rules. These limits are designed to provide reasonable protection against harmful interference in a residential installation. This equipment generates, uses and can radiate radio frequency energy and if not installed and used in accordance with the instructions, may cause harmful interference to radio communications. However, there is no guarantee that interference will not occur in a particular installation. If this equipment does cause harmful interference to radio or television reception, which can be determined by turning the equipment off and on, the user is encouraged to try to correct the interference by one or more of the following measures:

- Reorient or relocate the receiving antenna.
- Increase the separation between the equipment and receiver.
- Connect the equipment into an outlet on a circuit different from that to which the receiver is connected.

Consult dealer or an experienced radio/TV technician for help.

Industry Canada: ICES-003/NMB-003

This device complies with Industry Canada license - exempt RSS standard(s).

Operation is subject to the following two conditions:

1. This device may not cause interference, and
2. This device must accept any interference, including interference that may cause undesired operation of the device.

Parts Included

Accessories

Solar Charge Cable	1
12V DC Automotive Charge Cable	1
AC Charging Adapter	1
AC Charge Cable	1

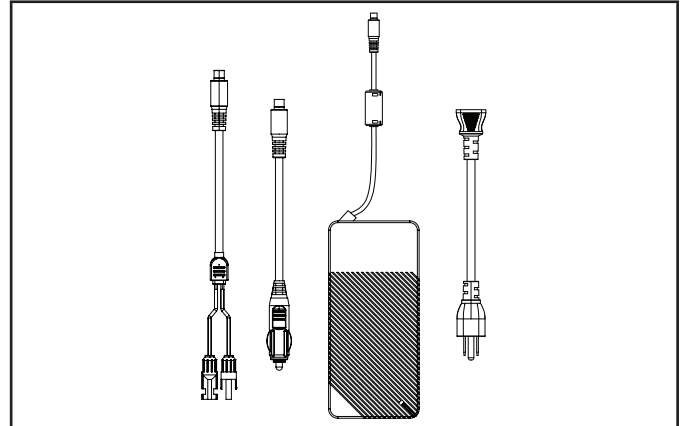

Parts Not Included

- Solar Panels

INITIAL USE

Your Power Station must be charged before first use.

If you have any questions regarding the use of your Power Station, call our Technical Support Team at 1-877-338-0999. Please have your serial number and model number available.

Unpacking

1. Set the shipping carton on a solid, flat surface.
2. Remove everything from the carton except the Power Station.
3. Using the carrying handle of the unit, carefully remove the Power Station from the box.

Grounding

Your Power Station must be properly connected to an appropriate ground to help prevent electric shock.

If the Power Station should malfunction or breakdown, grounding provides a path of least resistance for electric current to reduce the risk of electric shock. This product is equipped with a cord having an equipment grounding conductor and a grounding plug. The plug must be plugged into an outlet that is properly installed and grounded in accordance with all local codes ordinances. We strongly recommend that you consult with a qualified electrician to ensure compliance with local electrical codes.

Surge Protection

Electronic devices, including computers and many programmable appliances use components that are designed to operate within a narrow voltage range and may be affected by momentary voltage fluctuations. While there is no way to prevent voltage fluctuations, you can take steps to protect sensitive electronic equipment.

- Install UL1449, CSA-listed, plug-in surge suppressors on the outlets feeding your sensitive equipment. Surge suppressors come in single- or multi-outlet styles. They're designed to protect against virtually all short-duration voltage fluctuations.

Charging from Wall

NOTICE

The Power Station must be fully charged at least every 180 days when in storage, to keep the internal battery in good operating condition. Do not store the Power Station when battery level is at 20% or less state of charge (SOC). The ideal storage SOC is 40-60%.

1. Open the input port cover.
2. Plug the AC Charging Adapter Cable into the input port.

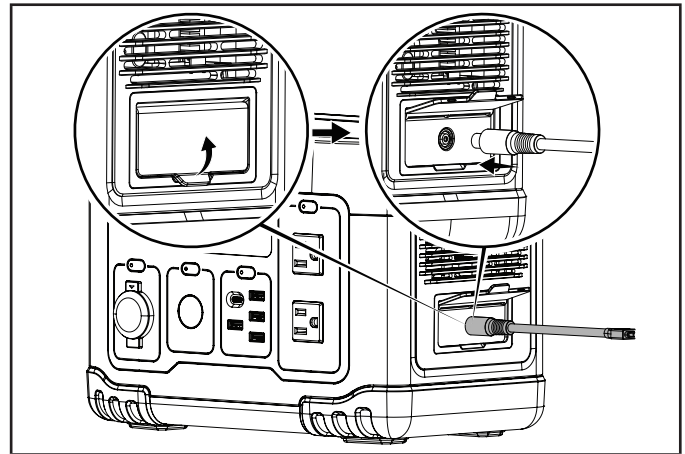

3. Plug the other end into a standard wall outlet. Ensure the cable is securely connected to the adapter.

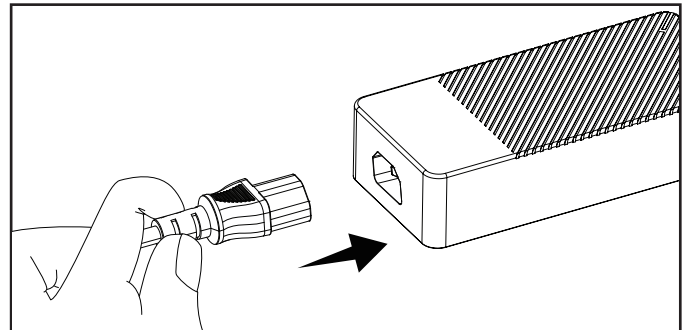

Using Included Solar Charge Cable

NOTICE

The Power Station's charging wattage is rated at 200W. However, depending on environmental conditions and solar panel efficiency, it may be necessary to use a solar panel rated higher than 200W to reach the full 200W of charging power. It will not damage the Power Station to use solar panels rated more than 200W as long as they are rated between 12-30V.

The charging power and rate is reduced as the battery level gets closer to 100% to safely charge the internal battery.

It is important to adjust your solar panels to face the sun as best as possible throughout the day to achieve maximum charging efficiency.

For example, on a cloudy day, a 300W or higher solar panel may be needed to produce 200W of charge. Ensure the solar panel is within the power station's required voltage and current range.

1. Open the input port cover.
2. Plug the solar charge cable into the input port.

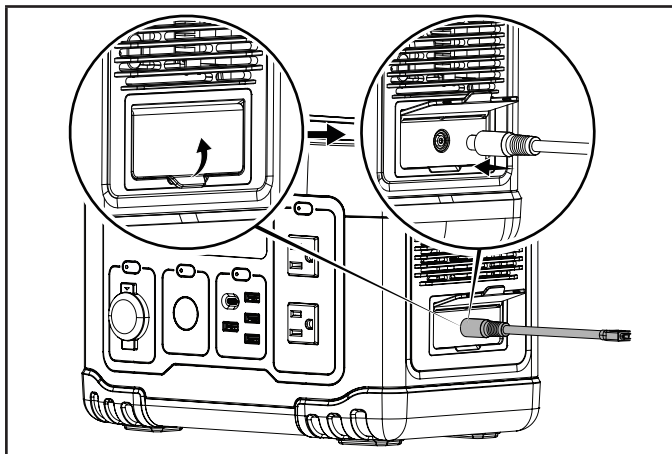

3. Connect solar panel using MC4 connectors.

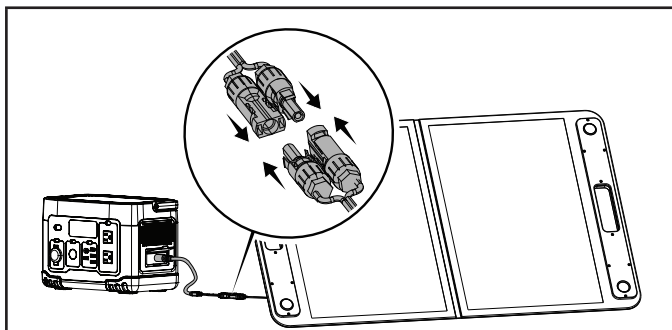

4. It is important to adjust your solar panels to face the sun as best as possible throughout the day to achieve maximum charging efficiency.

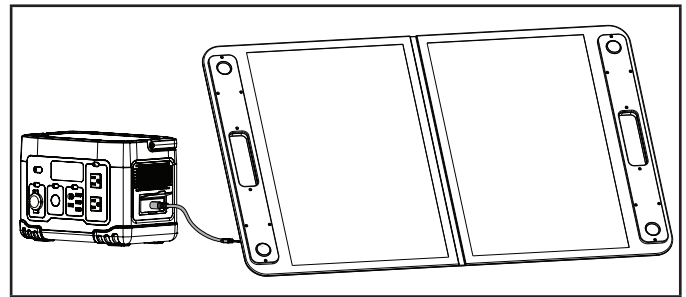

Recommended Solar Panels

NOTICE

It will not damage the Power Station to use solar panels rated more than 200W as long as they are rated between 12-30V.

Do not exceed voltage or current rating. Connecting solar panels in series will add their voltages and connecting solar panels in parallel will add their current together.

Model	Watts	Connector Type
Renogy RNG-100D-SS	100	MC4
Renogy Solar Panel 200 Watt 12 Volt	200	MC4
Bluetti SP120	120	MC4
Bluetti SP200	200	MC4
ECOFLOW EFSOLAR 160W	160	MC4
Champion 201246	120	MC4
Champion 201247	200	MC4

Any solar panel rated between 12-30V, 8A with MC4 connectors can be used. The Power Station has a built in MPPT solar charge controller and inverter so there is no need to buy an external charge controller, inverter, or worry about connecting more than 200W of solar panels to reach 200W of input on cloudy days.

Using 12V DC Automotive Charge Cable

1. Open the Input Cover.
2. Plug the automotive charge cable into the input port.

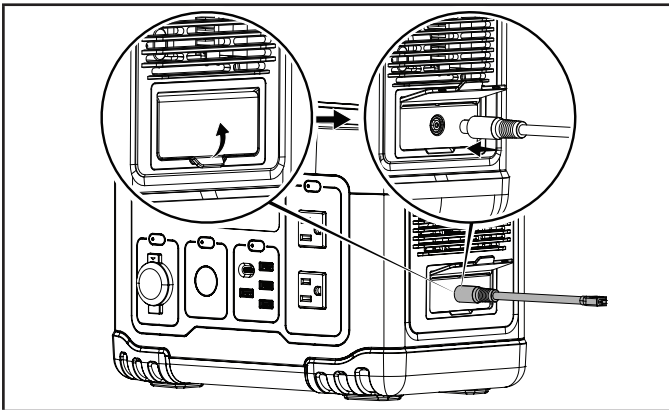

3. Connect the other end into a regulated 12V outlet.

OPERATION

Using the Power Station

1. Press and hold the power button for three seconds, until display illuminates.

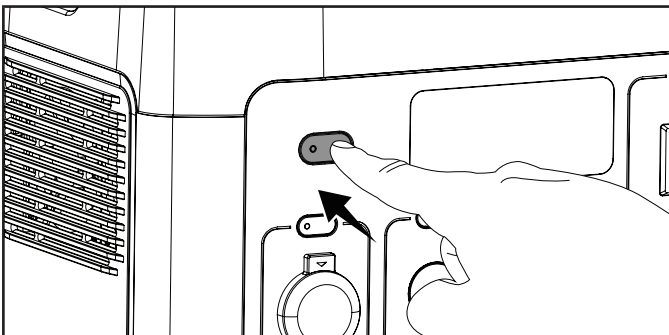

2. Press the appropriate button to turn on power for ports/ outputs intended to be used.

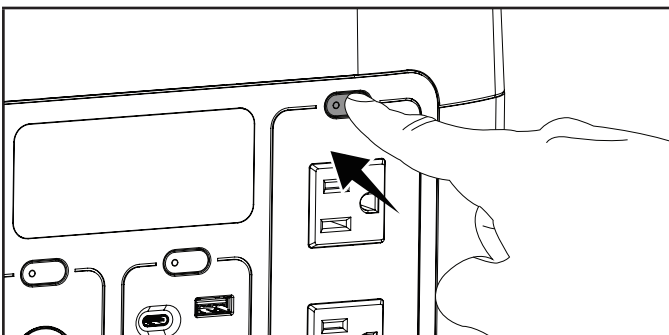

NOTICE

See *Specifications* section for maximum allowable watts. The sum of the watts of the 12V DC outlet, wireless charging pad, and USB ports can not exceed the number listed next to “DC Watts”. The 120V AC outlet(s) can not exceed the number listed next to “AC Running Watts” and “AC Starting Watts”.

All ports and outlets may be used simultaneously and each have their own wattage limits and protections.

NOTICE

To protect sensitive electronics, as the Power Station’s battery level drops to 5%, the AC output will be shutoff and fault indicator code E85 will be shown. DC and 12VDC ports can still be used. AC output will be restored once the power station is recharged.

3. Plug in desired devices.

Using the Wireless Charging Pad

1. Press the USB button.

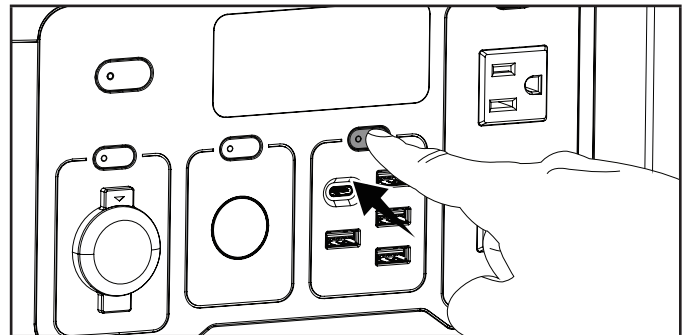

2. Place the device in the center of the charging pad. If the device is not centered on the pad, the device may not charge or charge slowly.

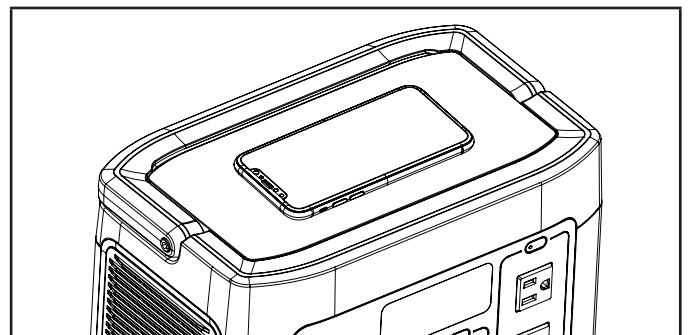

NOTICE

Ensure your device is compatible with wireless charging. Remove phone case for more efficient charging.

Standby Mode

The USB and 12V DC ports will remain in standby mode for 2 hours, then shut off if they do not supply at least 2W of power to an external device. The AC port(s) will remain in standby mode for 1 hour, then shut off if they do not supply at least 2W of power to an external device or appliance.

If the Power Station is left untouched with all outlets powered off for 2 hours, it will shut itself OFF. The Power Station will not shut off if it is plugged in and charging. In standby mode, the display will shut off to preserve power, and the power button will remain illuminated.

When the ports and outlets are powered on, the Power Station consumes about the same amount of power as one light bulb.

LED Light

1. To turn on LED low power mode press LED light button one time for low power, two times for high power, and three times for SOS mode.

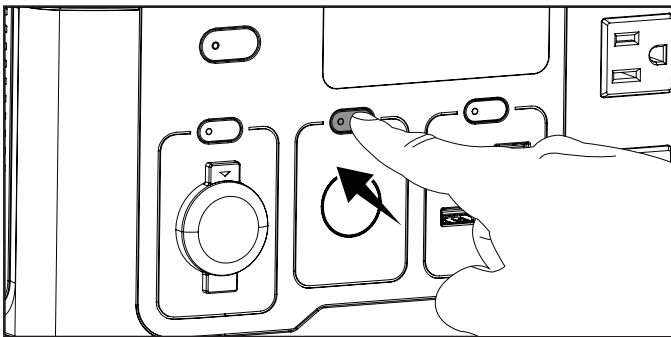

2. Press LED light button until LED light turns off.

Connecting Electrical Loads

⚠ WARNING

Always remember to plug your appliances directly into the Power Station and do not connect any of the several Power Station “outputs” into any electrical outlet or connect to the circuit breaker panel in your home. Connecting a Power Station to your home’s electric utility company’s power lines, or to another power source, called ‘backfeeding’ is a dangerous practice that is illegal in many states and municipalities.

This action if done incorrectly could damage your Power Station, appliances and could cause serious injury or death to you or a utility worker when attempting to restore power during an outage occurrence in the neighborhood who may then unexpectedly encounter high voltage on the utility line and suffer a fatal shock.

Whether injuries occur or not, if installed incorrectly and not to applicable laws and codes, you may be subject to fines or the utility company may disconnect your home power should this practice be found in your home.

If the Power Station will be connected to a building electrical system, those connections must isolate the Power Station power from the utility power. You are responsible for ensuring your Power Station’s electricity does not backfeed into the electric utility power lines. These connections must comply with all applicable laws and codes – Consult your local utility company or a qualified electrician to properly install this connection.

Resetting the Output

In case of an overload or fault on the AC, USB or DC outlets:

1. Unplug all devices from the overloaded ports/outlets, USB outlets will be restored automatically when devices are unplugged.
2. For AC and DC outlets. Press the button of the overloaded ports/outlets to restore power. Do not exceed your power station's maximum running or starting wattages.

AC Outlets

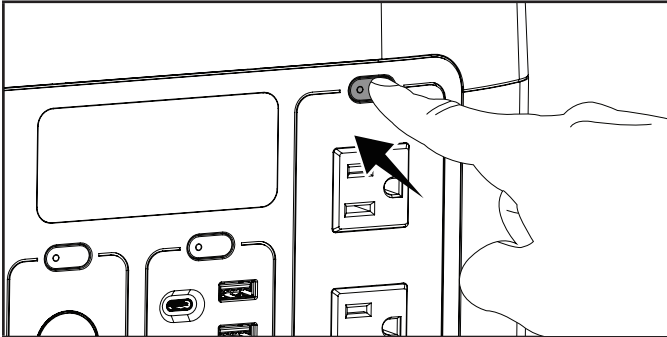

DC Outlets

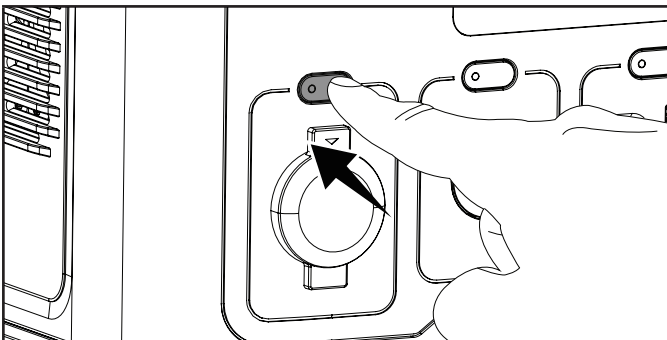

USB Ports

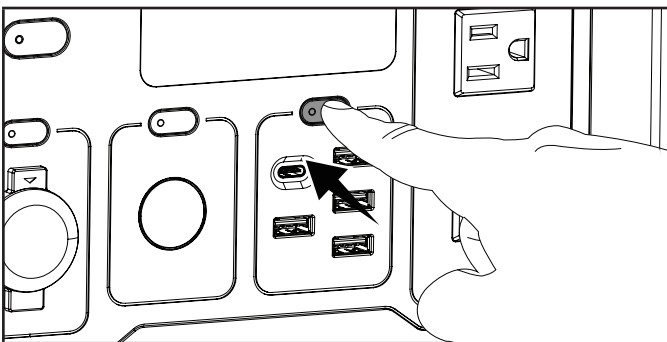

Do Not Overload Power Station

Calculating Run Time (Capacity)

Follow these simple steps to calculate the running and starting watts necessary for your purposes:

1. Select the electrical devices you plan on running at the same time.
2. Total the running watts of these items. This is the amount of power you need to keep your items running.
3. Identify the highest starting wattage of all devices identified in step 1. Add this number to the number calculated in step 2. Starting wattage is the surge of power needed to start some electric driven equipment. Following the steps listed under "Power Management" will guarantee that only one device will be starting at a time.

The total running watts from step 2 is how many **watts** the Power Station will discharge during one **hour** of run time, **watt-hours (Wh)**.

Divide the Power Station's capacity (Wh) by total running watts from step 2 to get the approximate available run time.

Example:

Step 2 total running watts: 90W

201189 inverter efficiency: 90%

$579Wh / 90W * 90\% =$ Approximately 6 hours of run time.

Power Management

Use the following formula to convert voltage and amperage to watts:

$$\text{Volts} \times \text{Amps} = \text{Watts}$$

To prolong the life of your Power Station and attached devices, follow these steps to add electrical load:

1. Start the Power Station with no electrical load attached.
2. Make sure power for the desired ports/outlets is ON and the LED indicator on the button is illuminated.
3. Plug in and turn on the first item. It is best to attach the item with the largest load first.
4. Plug in and turn on the next items one by one.

NOTICE

Never exceed the specified capacity when adding loads to the Power Station.

If your device is capable of using DC or AC power, it is more efficient to use DC power. Doing so also allows you to utilize more AC power through the Power Station's AC outlet(s).

Operation at High Altitude

The density and pressure of air at higher altitudes is lower than at sea level.

The increased pressure at higher altitudes can cause the battery to ignite faster if misused or punctured. The mass loss, heat release rate and total heat release for batteries decrease at low pressure, thereby experiencing faster internal battery arcing, and greater energy consumption with the higher altitudes and thinner atmosphere.

Turning Off the Power Station

If the Power Station is being charged, it will not be able to be turned off. The internal fans will continue running periodically to ensure the unit does not overheat.

1. Turn off and disconnect all devices.
2. Press and hold the power button for three seconds.

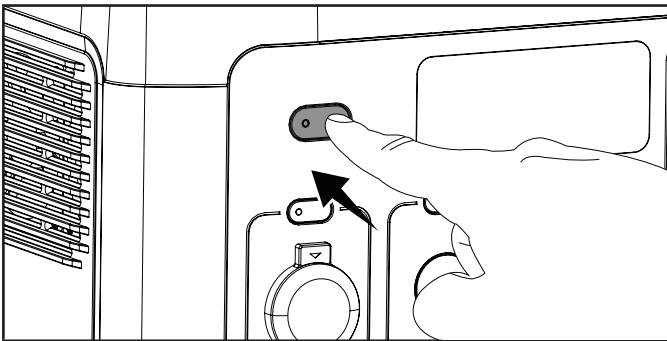

Moving the Power Station

1. Pick up the power station by the carrying handles as shown below.

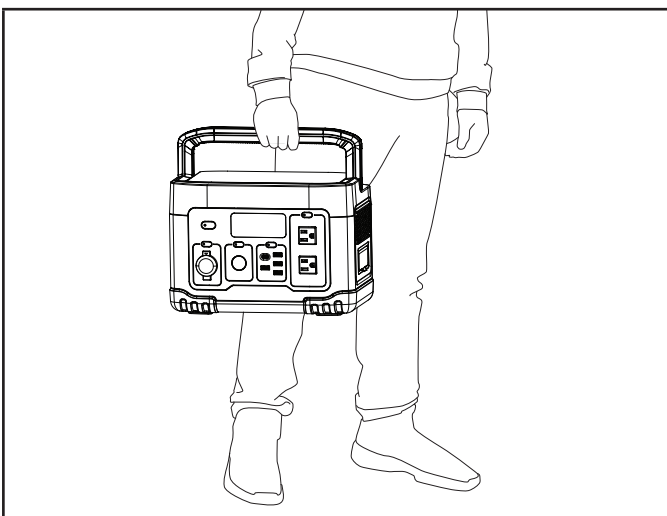

2. Move to desired location.

MAINTENANCE

Cleaning the Power Station

⚠ WARNING

DO NOT spray Power Station directly with water.

No user serviceable parts for maintenance required.

Water can enter the Power Station through the cooling slots and damage the Power Station electronics.

1. Use a damp cloth to clean exterior surfaces of the Power Station.
2. Use a soft bristle brush to remove dirt and debris.
3. Use an air compressor (25 PSI) to clear dirt and debris from the Power Station.
4. Inspect all air vents and cooling slots to ensure that they are clean and unobstructed.

STORAGE

- This Power Station is intended to be stored indoors and shall not be stored or left outdoors when not in use.
- Do not stack any items on top of the Power Station during storage.
- Store your Power Station in a cool, dry place between 32°F (0°C) and 104°F (40°C). The ideal storage temperature is 59°F (15°C).
- Do not store Power Station where temperatures may exceed 104°F (40°C) such as in direct sunlight, in a vehicle or metal buildings especially during the summer.
- Do not store the Power Station near sources of high heat or fire.
- Do not store the Power Station when battery level is at 20% or less state of charge (SOC). The ideal storage SOC is 40-60%.
- When storing the Power Station for periods of one month or longer, store the power station at an SOC of about 60%. Every three months, discharge the Power Station to 40% and recharge back to 60% to extend the battery life.
- Lithium batteries must be charged regularly to perform well. The Power Station must be fully charged by you at least once every 6 months (180 days).

SPECIFICATIONS

Power Station Specifications

Power Station Model	201189
AC Running Watts	600
AC Starting Watts	1200 (≤ 0.1 S)
DC Watts	249
AC + DC Watts	849
AC Volts	120
AC Amps @ 120V (Running)	5.0
DC Volts	See outlet specifications
DC Amps	See outlet specifications
Output Frequency	60 Hz
Phase	Single
Weight	15.9 lb. (7.2 kg)
Length	11.6 in. (29.4 cm)
Width	7.2 in. (18.4 cm)
Height	8.1 in. (20.7cm)

Battery Specifications

Chemistry	Lithium ion NMC
Pack Rated Output Voltage	22.2
Pack Capacity	579 Wh

AC Charger Specifications

Input Voltage	100-240 AC
Input Amps	3
Input Frequency	60/50 Hz
Output Voltage	25.2 DC
Output Amps	8
Output Watts	201.6

Solar Charge Specifications

Input Voltage	12-30 DC
Max. Input Amps	8
Input Watts	200

Automotive Charge Specifications

Input Voltage	12 DC
Max. Input Amps	8
Input Watts	96

Temperature Specifications

Charging Temperature Range ($^{\circ}$ F/ $^{\circ}$ C)	43 to 104/6 to 40
Discharging Temperature Range ($^{\circ}$ F/ $^{\circ}$ C)	5 to 104/-15 to 40

TROUBLESHOOTING

Problem	Cause	Solution
Power Station will not turn on.	Battery is not charged	Charge battery.
	Did not hold power button long enough	Hold for 3 full seconds until display turns on.
	Battery is faulty	Call Champion Support.
No power output. Warning icons or LED light flashing.	DC Outlets overloaded	Check display for overload indicator and ensure device's power demand does not exceed power stations output limit.
	AC outlets overloaded	Check display for overload indicator and ensure device's power demand does not exceed power station's output limit. If power still not restored, turn unit OFF for 1 minute then restart.
	Battery level at 5% or lower, preventing AC output (E85)	To protect sensitive electronics, as the Power Station's battery level drops to 5%, the AC output will be shutoff and fault indicator code E85 will be shown. USB and 12VDC ports can still be used. AC output will be restored when the power station is recharged above 7% or more.
	Device is faulty	Check all plugged in devices for frayed or faulty wires. Never run any equipment in wet or humid environments
	Device not compatible with USB outlet.	Check your devices' charging capability and try different USB outlet.
	Unit is too hot	Check display for flashing red High Temperature warning light. Turn the unit off, place it in the shade or a cooler area and let it cool down. Check that the unit is not overloaded.
	Unit is too cold	Check display for Low Temperature warning light. Turn the unit off and bring it indoors. Allow the unit to warm up.
	Battery fault	Check display for fault or error code. See Error Code list below. Call customer service if warning light does not go away.
Unit will not charge through wall.	Home circuit breaker tripped	Check your home's circuit breaker and reset if necessary.
	Faulty charging cable	Check that your charging cable is not frayed or faulty. Never charge your equipment in wet or humid conditions.
Unit will not charge through solar.	Solar panels are not within spec	Check that your solar panels are rated between 12-30V, 8A.
	Solar panels improperly connected	Ensure MC4 connectors are securely connected. Do not connect solar panels in parallel.
	Solar panels not receiving enough sunlight	Check that your solar panels are pointed directly at the sun and there is ample sunlight. Read your solar panel's instruction manual for proper placement and instructions.

Problem	Cause	Solution
Unit not charging at Solar Panel rated wattage.	Charging wattage depends on environmental conditions and panel efficiency.	Adjust your solar panels to face the sun as best as possible throughout the day to achieve maximum charging efficiency. It may be necessary to connect more than any combination of 200W of solar panels to reach the full 200W of charging power. For example, on a cloudy day, a 300W or higher solar panel may be needed to produce 200W of charge. Ensure the solar panel is within the power station's required voltage and current range.
	Unit is nearing 100% battery level and is slowing down to a safer charging rate.	The charging power and rate is reduced as the battery level gets closer to 100% to safely charge the internal battery.
Wireless Charging Pad not working or charging slowly.	Device not compatible with wireless charging.	Ensure your device is compatible with wireless charging.
	Device too far from induction coil.	Ensure device is centered on charging pad.
	USB Output OFF	Press USB button to turn USB output ON.

For other issues and technical support:

Technical Support Team
Toll Free 1-877-338-0999
support@championpowerequipment.com

POWER STATION FAULT INDICATOR CODES

If a problem arises with the Expansion Battery, a fault indicator code will flash on the Expansion Battery Intelligauge. To resolve the issue, follow the directions as indicated in the table below. For further information about Fault Codes, contact:

Technical Support Team

Toll Free 1-877-338-0999

support@championpowerequipment.com

Fault Code	Failure Description	Diagnosis
E00	Battery pack low temperature protection during charging	Please place the power station at room temperature and let the battery pack warm up before charging
E01	Battery pack high temperature protection during charging	Please place the power station at room temperature and keep the vents unobstructed, let the battery pack cool before charging
E03	Battery pack overvoltage protection during charging.	Discharge to below 95% and then charge the power station; Please contact customer service if the problem still exists.
E05	When charging or discharging, the battery pack is lower than 13.8V, and the battery pack cannot be used.	Please restart the power station. Please contact customer service if the problem still exists.
E09	Battery pack low temperature protection when discharging	Please place the power station at room temperature and let the battery pack warm up before discharging
E10	Battery pack high temperature protection when discharging	Please place the power station at room temperature and keep the vents unobstructed, let the battery pack cool before discharging
E11	SOC = 0% warning when discharging	Please charge the power station before using
E12	Battery pack low temp. & low voltage protection, AC output shut off.	Please use the power station at room temperature or use the power station when SOC > 80%
E16	AC output overcurrent protection	Please reduce the output and continue using power station.
E17	AC output high temperature protection	Please place the power station at room temperature and keep the vents unobstructed. Use the power station after cooling
E20	AC output protection due to low voltage or low voltage caused by short circuit, over current	Please restart the power station. Please contact customer service if the problem still exists.
E21	AC output high voltage protection	Please restart the power station. Please contact customer service if the problem still exists.
E22	AC output short circuit protection	Remove the load and ensure load does not exceed rated power.
E24	Abnormal communication warning between the control panel and the inverter	Please restart the power station. Please contact customer service if the problem still exists.
E25	Inverter bus with low voltage	Please restart the power station. Please contact customer service if the problem still exists.
E26	Inverter bus with high voltage	Please restart the power station. Please contact customer service if the problem still exists.
E27	The inverter boosting module is too high-high temp. protection	Please place the power station at room temperature and Keep the vents unobstructed, let the battery pack cool before charging
E28	Inverter low temperature protection	Please place the power station at room temperature and restart the power station after warm up. Please contact customer service if the problem still exists.
E30	The inverter boosting module low temperature, low temp. protection	Please place the power station at room temperature and restart the power station after warm up. Please contact customer service if the problem still exists.

Fault Code	Failure Description	Diagnosis
E32	Charger input voltage is high, overvoltage protection	Please use the standard charger to charge the power station, or ensure that the input voltage is within the specified range.
E33	Car Charger output short circuit protection	Remove the load then reset the ports, Please contact customer service if the problem still exists.
E34	Car Charger output over voltage protection	Disconnect the load then reset the ports, Please contact customer service if the problem still exists.
E35	Car Charger output low voltage protection; or low voltage due to short circuit, over current	Disconnect the load and restart the power station. Please contact customer service if the problem still exists.
E38	The input voltage is lower than 12V when charging	Please use the standard charger to charge the power station, or ensure that the input voltage is within the specified range.
E39	12V DC module high temperature protection	Please place the power station at room temperature and keep the vents unobstructed. Use the power station after cooling
E40	The communication between the charging control chip and the MCU is abnormal	Disconnect the adapter and restart the power station. Please contact customer service if the problem still exists.
E41	Charging control chip high temperature protection	Please place the power station at room temperature and keep the vents unobstructed. Use the power station after cooling
E44	USB overvoltage protection	Remove the load then reset the ports
E45	USB(upper and middle) short circuit/over current protection	Remove the load then reset the ports
E47	USB (lower) short circuit/over current protection	Remove the load then restart the ports, the power station will be recovered.
E48	QC3.0 with overvoltage protection	Remove the load then restart the ports, the power station will be recovered.
E49	QC3.0 with overcurrent/short circuit protection	Remove the load then restart the ports, the power station will be recovered.
E50	The PD65W chip and control panel with abnormal communication.	Remove the load then restart the ports, the power station will be recovered.
E51	PD65W short circuit protection.	Remove the load then restart the ports, the power station will be recovered.
E52	PD65W high temp. protection.	Please place the power station at room temperature and Keep the vents unobstructed. Use the power station after cooling
E53	POWER button is disabled	Press the button. Please contact customer service if the problem still exists.
E54	DC button is disabled	Press the button. Please contact customer service if the problem still exists.
E55	AC button is disabled	Press the button. Please contact customer service if the problem still exists.
E56	USB button is disabled	Press the button. Please contact customer service if the problem still exists.
E57	LED button is disabled	Press the button. Please contact customer service if the problem still exists.
E72	Control panel and BMS abnormal communication	Please restart the power station. Please contact customer service if the problem still exists.
E77	High temp. alarms when battery pack surface temperature $\geq 60^{\circ}\text{C}$	Please use the power station at room temperature or reduce AC load and Keep the vents unobstructed.
E78	High temp. protection when battery pack surface temperature $\geq 64^{\circ}\text{C}$, AC & 12V DC turn off ,the USB & PD port goes on working.	Please place the power station at room temperature and Keep the vents unobstructed. Use the power station after cooling
E85	If the SOC is $\leq 5\%$, AC output turns off.	It will be eliminated after charging to SOC $> 7\%$
E88	The over 60% of rated power is prohibited at low temperature	Keep the power station at room temperature. Use the power station after the temperature rises or reduce the discharge power

WARRANTY*

CHAMPION POWER EQUIPMENT

2 YEAR or 800 CYCLE LIMITED WARRANTY

Warranty Qualifications

To register your product for warranty and FREE lifetime call center technical support please visit:

<https://www.championpowerequipment.com/register>

To complete registration you will need to include a copy of the purchase receipt as proof of original purchase. Proof of purchase is required for warranty service. Please register within ten (10) days from date of purchase.

Repair/Replacement Warranty

CPE warrants to the original purchaser that the components will be free of defects in material and workmanship for a period of two (2) years or 800 cycles (parts and labor), whichever occurs first, from the original date of purchase and 90 days (parts and labor) for commercial and industrial use. Transportation charges on product submitted for repair or replacement under this warranty are the sole responsibility of the purchaser. This warranty only applies to the original purchaser and is not transferable.

Do Not Return The Unit To The Place Of Purchase

Contact CPE's Technical Service and CPE will troubleshoot any issue via phone or e-mail. If the problem is not corrected by this method, CPE will, at its option, authorize evaluation, repair or replacement of the defective part or component at a CPE Service Center. Please keep it for future reference. Repairs or replacements without prior authorization, or at an unauthorized repair facility, will not be covered by this warranty.

Warranty Exclusions

This warranty does not cover the following repairs and equipment:

Normal Wear

Products with lithium batteries should be charged regularly to perform well. The Power Station must be fully charged by you at least once every 6 months (180 days). This warranty does not cover repair when normal use has exhausted the life of a part, like the batteries, or the equipment.

Installation, Use and Maintenance

This warranty will not apply to parts and/or labor if the product is deemed to have been misused, neglected, involved in an accident, abused, loaded beyond the product's limits, modified, installed improperly or connected incorrectly to any electrical component. Normal maintenance is not covered by this warranty and is not required to be performed at a facility or by a person authorized by CPE.

Other Exclusions

This warranty excludes:

- Items purchased from unauthorized resellers.
- Any defects or damages caused by exposure to excessive heat, cold, corrosive or conductive fluids, liquids such as water, seawater, industrial chemicals, bleach or bleach containing products or other external causes.
- Warranty claims on items taken outside the original country of purchase
- Cosmetic defects on plastic, labels, etc.
- Failures due to acts of God and other force majeure events beyond the manufacturer's control.
- Problems caused by parts that are not original Champion Power Equipment parts.
- Any battery cell or product containing a battery cell unless the battery cell has been fully charged after purchase of the product and at least once every 6 months (180 days) thereafter.

Limits of Implied Warranty and Consequential Damage

Champion Power Equipment disclaims any obligation to cover any loss of time, use of this product, freight, or any incidental or consequential claim by anyone from using this product.

A unit provided as an exchange will be subject to the warranty of the original unit. The length of the warranty governing the exchanged unit will remain calculated by reference to the purchase date of the original unit.

This warranty gives you certain legal rights which may change from state to state or province to province. Your state or province may also have other rights you may be entitled to that are not listed within this warranty.

Contact Information

Address

Champion Power Equipment, Inc.
6370 S Pioneer Way, Unit 101
Las Vegas, NV 89113 USA
www.championpowerequipment.com

Customer Service

Toll Free: 1-877-338-0999
support@championpowerequipment.com
Fax no.: 1-562-236-9429