

- en**
- 1 T time delay range
 - 2 T time delay setting
 - 3 Function selection
 - 4 LED Indication (Except solid state output)
 - 5 Un/R: Un for Power Supply Indication / R for Relay Output

- de**
- 1 Verzögerungsbereich T
 - 2 Verzögerungseinstellung T
 - 3 Funktionsauswahl
 - 4 LED-Anzeige (außer Halbleiterausgang)
 - 5 Un/R: Un für Spannungsversorgung / R für Relaisausgang

- it**
- 1 Gamma di temporizzazione T
 - 2 Regolazione temporizzazione T
 - 3 Selezione funzione
 - 4 Indicazione LED (eccetto uscita statica)
 - 5 Un/R: Un per Indicazione di alimentazione / R per Uscita relè

- fr**
- 1 Gamme de temporisation T
 - 2 Réglage temporisation T
 - 3 Sélection de fonction
 - 4 Voyant (sauf la sortie statique)
 - 5 Un/R : Un pour Indicateur d'alimentation / R pour Sortie relais

- es**
- 1 Gama de temporización T
 - 2 Reglaje temporización T
 - 3 Selección de la función
 - 4 Indicador LED (excepto la salida de estado sólido)
 - 5 Un/R: Un para Indicador de la fuente de alimentación / R para Salida de relé

- zh**
- 1 时间范围的确定 T
 - 2 延时时间设定 T
 - 3 功能选择
 - 4 LED 指示 (固态输出除外)
 - 5 Un/R: Un 对应电源指示 / R 对应继电器输出

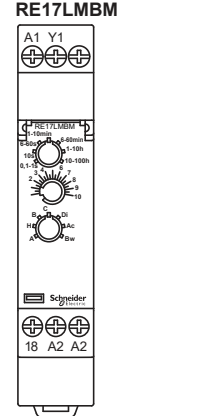
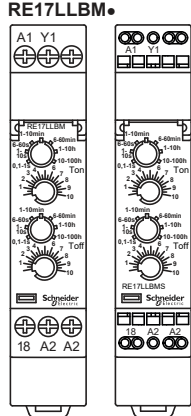
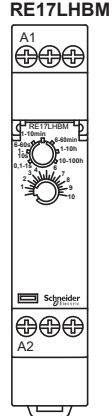
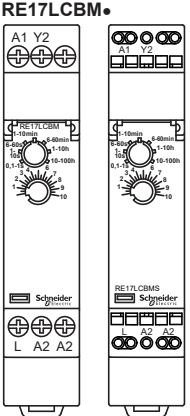
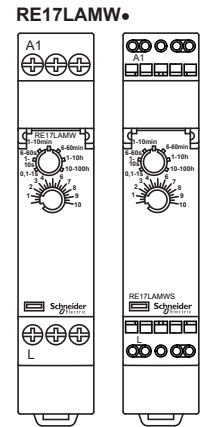
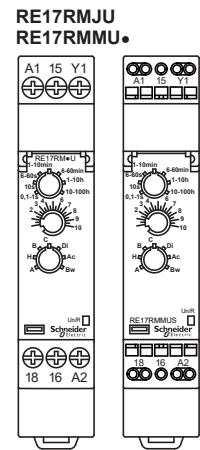
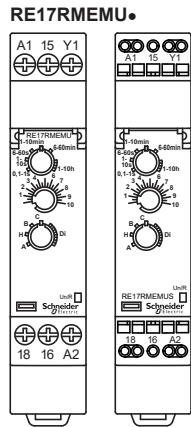
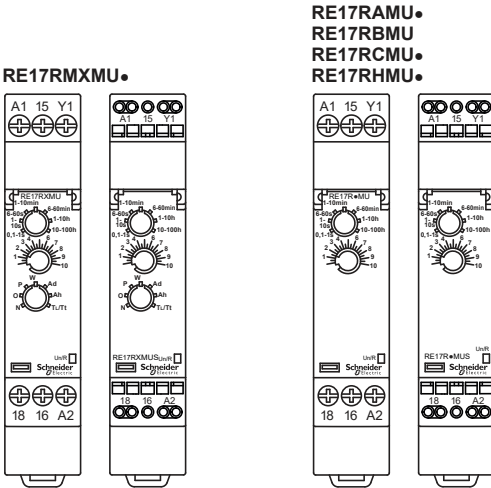
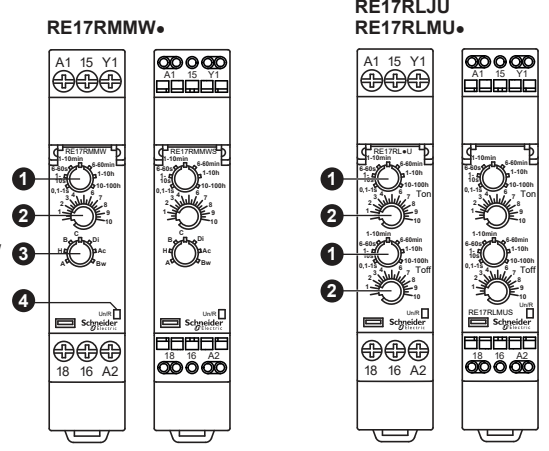

Note:
References ending with 'S' are spring terminals (right), references without 'S' are screw terminals (left).

Functions / Fonctions / Funktionen / Funciones / Funzione / 功能

- en**
- U: Supply
 - R: Relay or solid state output
 - T: Timing period
 - Y1: Control contact
 - Ta: Adjustable On-delay
 - Tr: Adjustable Off-delay

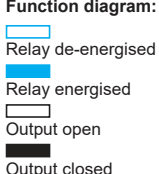

- fr**
- U: Alimentation
 - R: Sortie relais ou statique
 - T: Temporisation
 - Y1: Commande
 - Ta: Temporisation travail réglable
 - Tr: Temporisation repos réglable

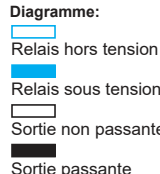

- de**
- U: Spannungsversorgung
 - R: R: Relais- oder Halbleiterausgang
 - T: Verzögerung
 - Y1: Steuerkontakt
 - Ta: Einstellbare Ansprechverzögerung
 - Tr: Einstellbare Rückfallverzögerung

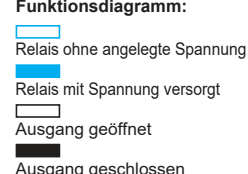

- es**
- U: Alimentación
 - R: Salida de estado sólido o relé
 - T: Período de temporización
 - Y1: Contacto de control
 - Ta: Retardo de conexión ajustable
 - Tr: Retardo de desconexión ajustable

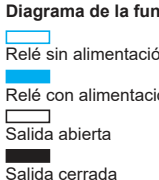

- it**
- U: Alimentazione
 - R: Uscita relè o statica
 - T: Temporizzazione
 - Y1: Comando
 - Ta: Temporizzazione funzionamento regolabile
 - Tr: Temporizzazione riposo regolabile

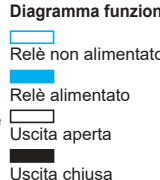

- zh**
- U: 电源
 - R: 继电器或固态输出
 - T: 定时时段
 - Y1: 控制触点
 - Ta: 可调节接通延迟
 - Tr: 可调节断开延迟

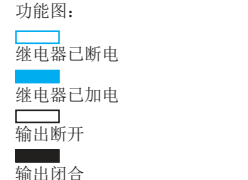

- A** RE17RMMW• RE17RMMU•
RE17RAMU• RE17LAMW•
RE17RMEMU• RE17LMBM
RE17RMJU
- en Power on delay relay
 - fr Relais temporisé à la mise sous tension
 - de Ansprechverzögertes Zeitrelais
 - es Relé de retardo de arranque
 - it Relè ritardato all'accensione
 - zh 开启延迟继电器电源



- Ac** RE17RMMW• RE17RMMU•
RE17RMJU RE17LMBM
- en On- and off-delay relay with control signal
 - fr Relais de temporisation travail et repos avec signal de contrôle
 - de Ansprech- und rückfallverzögertes Zeitrelais mit Steuersignal
 - es Relé de retardo de conexión y desconexión con señal de control
 - it Relè ritardato all'inserzione e alla disinserzione con segnale di comando
 - zh 具有控制信号的接通-断开延迟继电器

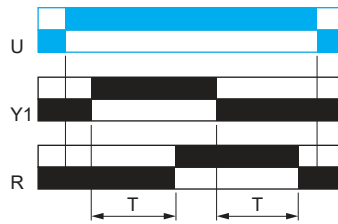

- Ad** RE17RMXMU•
- en Pulse delayed relay with control signal
 - fr Relais à impulsion temporisée avec signal de contrôle
 - de Impulsverzögertes Zeitrelais mit Steuersignal
 - es Relé de retardo de pulso con señal de control
 - it Relè a impulso ritardato con segnale di comando
 - zh 具有控制信号的脉冲延迟继电器

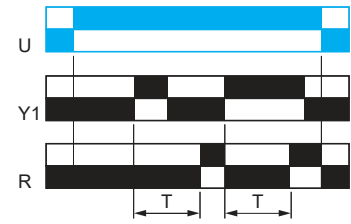

- Ah** RE17RMXMU•
- en Pulse delayed relay (single cycle) with control signal
 - fr Relais à impulsion temporisée (un seul cycle) avec signal de contrôle
 - de Impulsverzögertes Zeitrelais (einfacher Zyklus) mit Steuersignal
 - es Relé de retardo de pulso (ciclo único) con señal de control
 - it Relè a impulso ritardato (ciclo singolo) con segnale di comando
 - zh 具有控制信号的脉冲延迟继电器 (单循环)

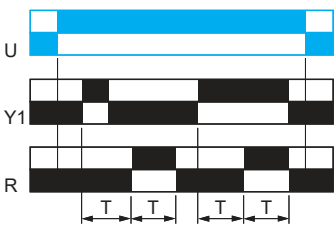

- At** RE17RMMW• RE17RMJU
RE17RAMU• RE17RMMU•
RE17RMEMU• RE17LMBM
- en Power on delay relay (summation) with control signal
 - fr Relais temporisé à la mise sous tension (somme) avec signal de contrôle
 - de Ansprechverzögertes Zeitrelais (additiv) mit Steuersignal
 - es Relé de retardo de arranque (suma) con señal de control
 - it Relè ritardato all'accensione (somma) con segnale di comando
 - zh 开启具有控制信号的延迟继电器 (求和) 电源

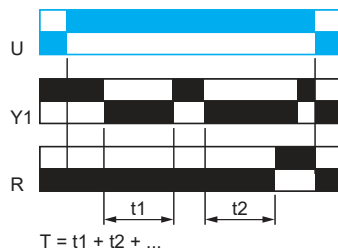

- B** RE17RMMW• RE17RMJU
RE17RBMU RE17RMMU•
RE17RMEMU• RE17LMBM
- en Interval relay with control signal
 - fr Relais d'intervalle avec signal de contrôle
 - de Wischrelais mit Steuersignal
 - es Relé de intervalo con señal de control
 - it Relè a intervallo con segnale di comando
 - zh 具有控制信号的间隔定时继电器

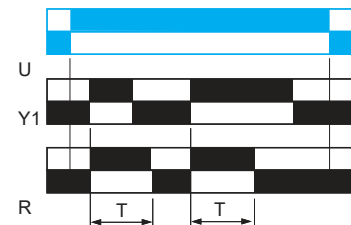

- Bw** RE17RMMW• RE17RMMU•
RE17RMJU RE17LMBM
- en Double interval relay with control signal
 - fr Relais d'intervalle double avec signal de contrôle
 - de Doppeltes Wischrelais mit Steuersignal
 - es Relé de intervalo doble con señal de control
 - it Relè a doppio intervallo con segnale di comando
 - zh 具有控制信号的双间隔定时继电器

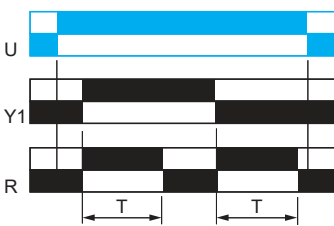

- C** RE17RMMW• RE17RMMU•
RE17RCMU• RE17LCBM•
RE17RMEMU• RE17LMBM
RE17RMJU
- en Off-delay relay with control signal
 - fr Relais de temporisation repos avec signal de contrôle
 - de Rückfallverzögertes Zeitrelais mit Steuersignal
 - es Relé de retardo de desconexión con señal de control
 - it Relè ritardato alla disinserzione con segnale di comando
 - zh 具有控制信号的断开延迟继电器

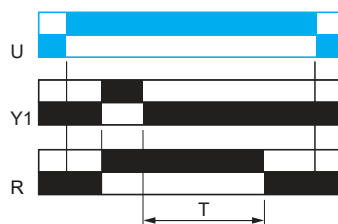

- D** RE17RMMW• RE17RMMU•
RE17RMEMU• RE17LMBM
RE17RMJU
- en Symmetrical flasher relay (starting pulse off)
 - fr Relais de clignotant symétrique (impulsion de départ repos)
 - de Symmetrisches Blinkrelais (pausebeginnend)
 - es Relé señalizador simétrico (pulso inicial desconectado)
 - it Relè a intermittenza simmetrica (impulso avvio off)
 - zh 对称式闪光继电器 (启动脉冲停止)

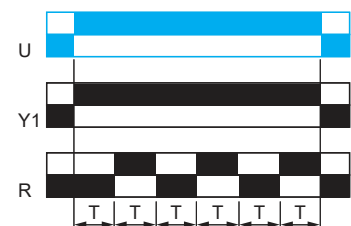

- Di** RE17RMMW• RE17RMMU•
RE17RMEMU• RE17LMBM
RE17RMJU
- en Symmetrical flasher relay (starting pulse on)
 - fr Relais de clignotant symétrique (impulsion de départ travail)
 - de Symmetrisches Blinkrelais (impulsbeginnend)
 - es Relé señalizador simétrico (pulso inicial conectado)
 - it Relè a intermittenza simmetrica (impulso avvio on)
 - zh 对称式闪光继电器 (启动脉冲开启)

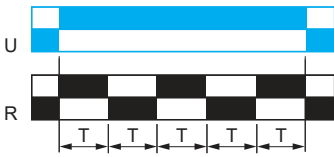

- H** RE17RMMW• RE17RMMU•
RE17RHMU• RE17LHBM
RE17RMEMU• RE17LMBM
RE17RMJU
- en Interval relay
 - fr Relais d'intervalle
 - de Wischrelais
 - es Relé de intervalo
 - it Relè intervallo
 - zh 间隔定时继电器



- Ht** RE17RMMW• RE17RMJU
RE17RHMU• RE17RMMU•
RE17RMEMU• RE17LMBM
- en Interval relay (summation) with control signal
 - fr Relais d'intervalle (somme) avec signal de contrôle
 - de Wischrelais (additiv) mit Steuersignal
 - es Relé de intervalo (suma) con señal de control
 - it Relè a intervallo (somma) con segnale di comando
 - zh 具有控制信号的间隔定时继电器 (求和)

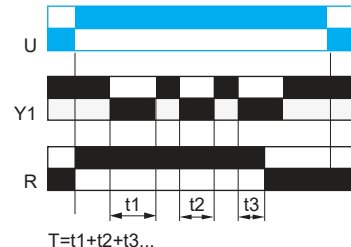

L RE17RLJU
RE17RLMU•
RE17LLBM•

- en** Asymmetrical flasher relay (starting pulse off)
- fr** Relais de clignotant asymétrique (impulsion de départ repos)
- de** Asymmetrisches Blinkrelais (pausebeginnend)
- es** Relé señalizador asimétrico (pulso inicial desconectado)
- it** Relè a intermittenza asimmetrica (impulso avvio off)
- zh** 非对称式闪光继电器 (启动脉冲停止)

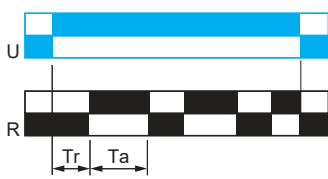

Li RE17RLJU
RE17RLMU•
RE17LLBM•

- en** Asymmetrical flasher relay (starting pulse on)
- fr** Relais de clignotant asymétrique (impulsion de départ travail)
- de** Asymmetrisches Blinkrelais (impulsbeginnend)
- es** Relé señalizador asimétrico (pulso inicial conectado)
- it** Relè a intermittenza asimmetrica (impulso avvio on)
- zh** 非对称式闪光继电器 (启动脉冲开启)

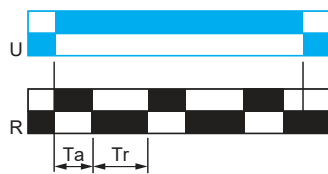

N RE17RMXMU•

- en** Retriggerable interval relay with control signal on
- fr** Relais d'intervalle redéclenchable avec signal de contrôle travail
- de** Nachtriggerbares Wischrelais mit Steuersignal
- es** Relé de intervalo redisparable con señal de control activada
- it** Relè a intervallo ripristinabile all'invio del segnale di comando
- zh** 开启控制信号的可再触发式间隔定时继电器

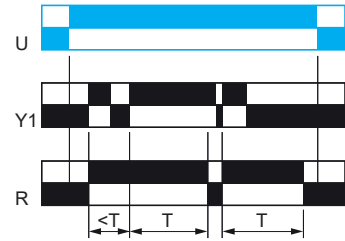

O RE17RMXMU•

- en** Retriggerable interval delayed relay with control signal on
- fr** Relais temporisé d'intervalle redéclenchable avec signal de contrôle travail
- de** Nachtriggerbares intervallverzögertes Zeitrelais mit Steuersignal
- es** Relé de retardo de intervalo redisparable con señal de control activada
- it** Relè a intervallo ritardato ripristinabile all'invio del segnale di comando
- zh** 开启控制信号的可再触发式间隔延迟继电器

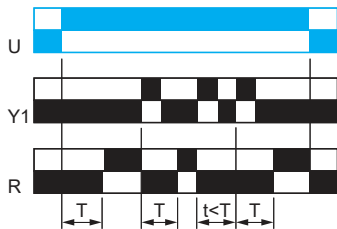

P RE17RMXMU•

- en** Pulse delayed relay with fixed pulse length
- fr** Relais à impulsion temporisée avec longueur d'impulsion fixe
- de** Impulsverzögertes Zeitrelais mit fester Impulslänge
- es** Relé de retardo de pulso con duración fija del pulso
- it** Relè a impulso ritardato con lunghezza impulso fissa
- zh** 具有混合脉冲长度的脉冲延迟继电器

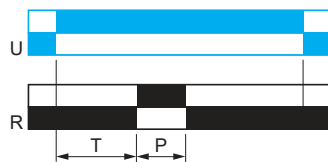

P = 500 ms

Pt RE17RMXMU•

- en** Pulse delayed relay (summation and fixed pulse length) with control signal off
- fr** Relais à impulsion temporisée (somme et longueur d'impulsion fixe) avec signal de contrôle repos
- de** Impulsverzögertes Zeitrelais (additiv und feste Impulslänge) ohne Steuersignal
- es** Relé con retardo de pulso (suma y duración fija de pulso) con señal de control desactivada
- it** Relè a impulso ritardato (somma e lunghezza impulso fissa) senza segnale di comando
- zh** 关闭控制信号的脉冲延迟继电器 (求和混合脉冲长度)

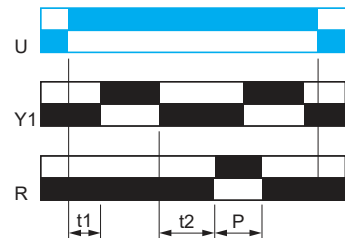

T = t1 + t2 + ...
P = 500 ms

Tl RE17RMXMU•

- en** Bistable relay with control signal on
- fr** Relais bistable avec signal de contrôle travail
- de** Bistabiles Relais mit Steuersignal
- es** Relé biestable con señal de control activada
- it** Relè biestabile con invio segnale di comando
- zh** 开启控制信号的双稳态继电器

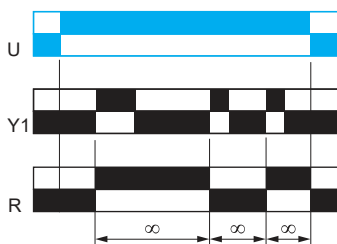

Tt RE17RMXMU•

- en** Retriggerable bistable relay with control signal on
- fr** Relais bistable redéclenchable avec signal de contrôle travail
- de** Nachtriggerbares bistabiles Relais mit Steuersignal
- es** Relé biestable redisparable con señal de control activada
- it** Relè biestabile ripristinabile all'invio del segnale di comando
- zh** 开启控制信号的可再触发式双稳态继电器

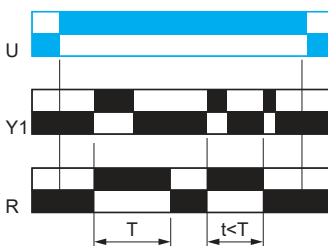

W RE17RMXMU•

- en** Interval relay with control signal off
- fr** Relais d'intervalle avec signal de contrôle repos
- de** Wischrelais ohne Steuersignal
- es** Relé de intervalo con señal de control desactivada
- it** Relè a intervallo senza segnale di comando
- zh** 关闭控制信号的间隔定时继电器

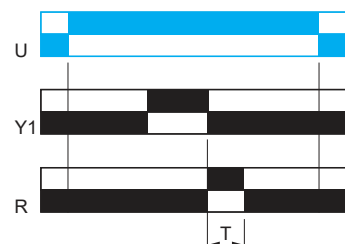

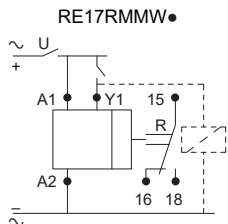
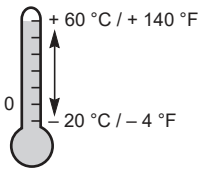

U	12...240 Vdc 1.5 W
U	12...240 Vac 50...60 Hz 3 VA
	250 Vac / 8 A

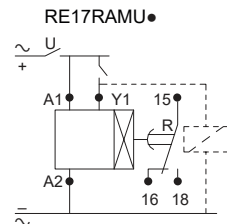

U	24 Vdc 0.6 W
U	24...240 Vac 50...60 Hz 32 VA
	250 Vac / 8 A

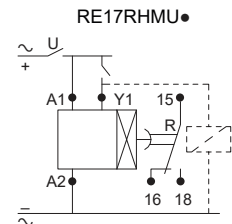

U	24 Vdc 0.6 W
U	24...240 Vac 50...60 Hz 32 VA
	250 Vac / 8 A

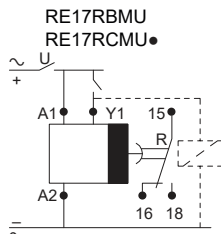

U	24 Vdc 0.6 W
U	24...240 Vac 50...60 Hz 32 VA
	250 Vac / 8 A

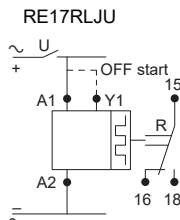

U	12 Vdc 0.5 W
U	12 Vac 50...60 Hz 0.7 VA
	250 Vac / 8 A

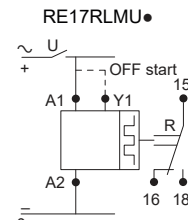

U	24 Vdc 0.6 W
U	24...240 Vac 50...60 Hz 32 VA
	250 Vac / 8 A

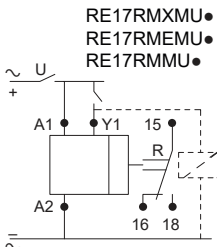

U	24 Vdc 0.6 W
U	24...240 Vac 50...60 Hz 32 VA
	250 Vac / 8 A

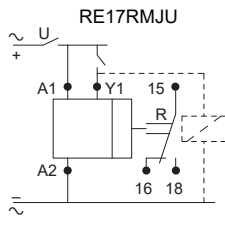

U	12 Vdc 0.5 W
U	12 Vac 50...60 Hz 0.7 VA
	250 Vac / 8 A

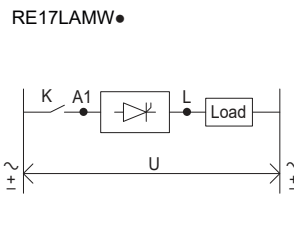

U	24...240 Vdc
U	24...240 Vac 50...60 Hz
	0.7 A (20 °C)

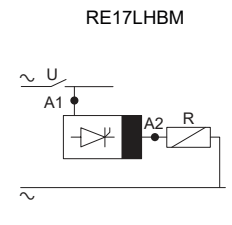

U	24...240 Vac 50...60 Hz
	0.7 A (20 °C)

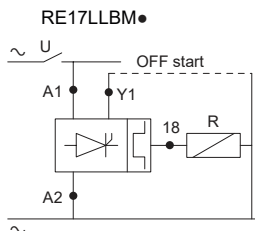

U	24...240 Vac 50...60 Hz
	0.7 A (20 °C)

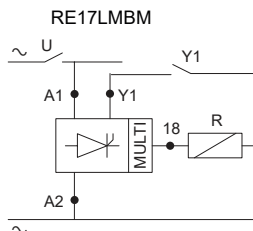

U	24...240 Vac 50...60 Hz
	0.7 A (20 °C)

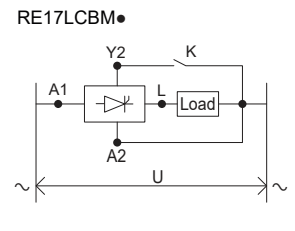

U	24...240 Vac 50...60 Hz
	0.7 A (20 °C)

Wire sizes and torque / Calibre de fils et couple / Drahtstärken und Anzugsmoment / Tamaños de cable y par de apriete / Sezioni filo e coppia / 电线尺寸和扭矩

For all references with screw terminals (RE17...) / Pour toutes les références avec bornes à vis (RE17...) / Für alle Referenzen mit Schraubklemmen (RE17...) / Para todas las referencias con terminales de tornillo (RE17...) / Per tutti i codici prodotto con morsettiere a vite (RE17...) / 具有螺钉端子的所有型号 (RE17...)

mm in.	6 0.24				
mm ²		0.5...3.33	0.5...2.5	0.2...2.5	0.2...1.5
AWG		20...12	20...14	24...14	24...16

		N•m	0.6...1
Ø 3.5 mm / 0.14 in.		lb-in	5.3...8.8

For all references with spring terminals (RE17...S) / Pour toutes les références avec bornes à ressort (RE17...S) / Für alle Referenzen mit Federklemmen (RE17...S) / Para todas las referencias con terminales de resorte (RE17...S) / Per tutti i codici prodotto con morsettiere a molla (RE17...S) / 具有弹簧端子的所有型号 (RE17...S)

mm in.	8 0.31		
mm ²		0.2...1.5	0.2...1.5
AWG		24...16	24...16

• Flathead screwdriver, Parallel tip / Tournevis plat, pointe parallèle /
Flachkopf-Schraubendreher, parallele Spitze /
Destornillador de cabeza plana, punta paralela /
Cacciavite a testa piatta, punta parallela / 一字螺丝刀, 平行尖端

• Flathead screwdriver, Flared tip / Tournevis plat, pointe évasée /
Flachkopf-Schraubendreher, aufgeweitete Spitze /
Destornillador de cabeza plana, punta ancha /
Cacciavite a testa piatta, punta svasata / 一字螺丝刀, 外展尖端

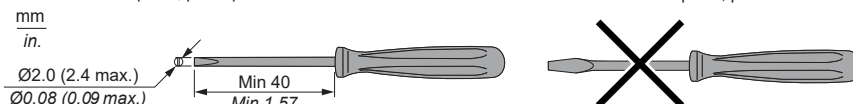

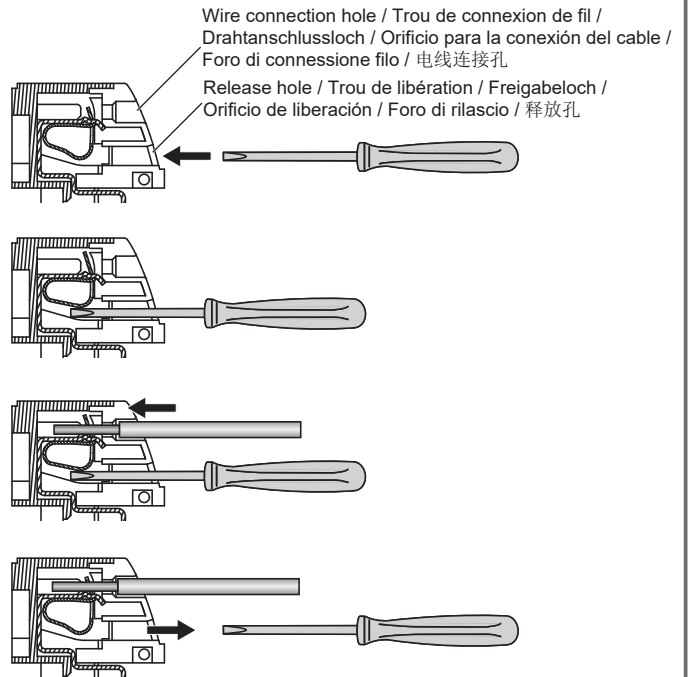
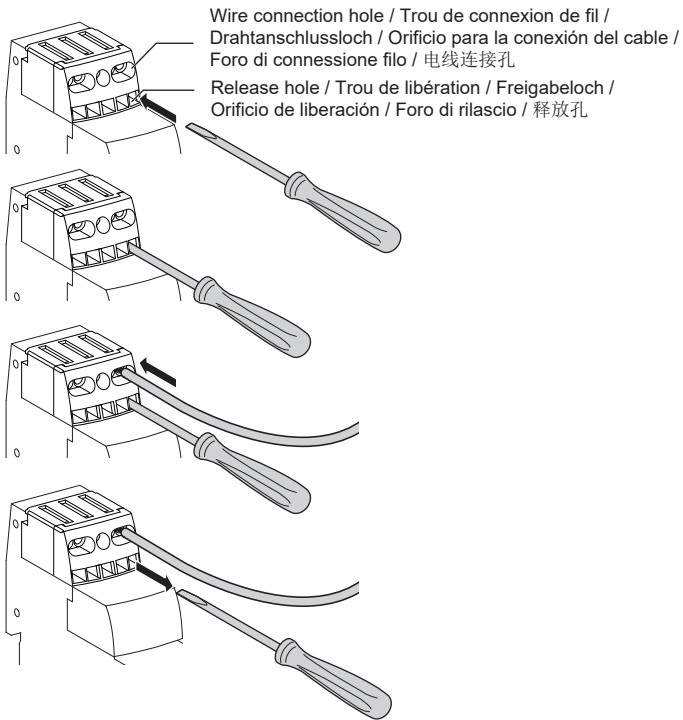

3 Set / Réglez / Einstellung / Regule / Regolate / 设定

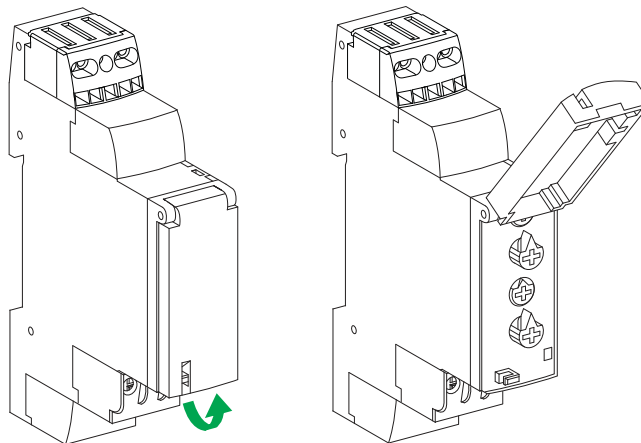

T ≤ 10 min 分钟

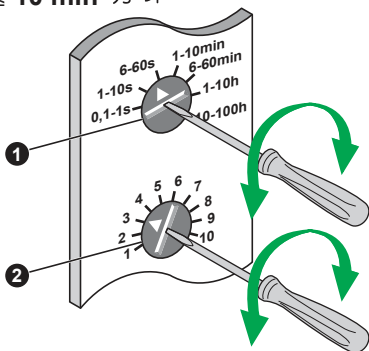

T ≥ 10 min 分钟

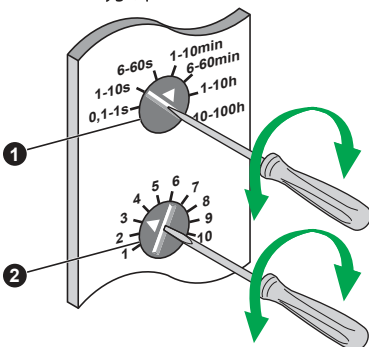

Example / Exemple / Biespiel / Ejemplo / Esempio / 例子

	①	➔	②
T = 60 s		➔	
		➔	
T = 45 s		➔	

NOT RECOMMENDED /
 NON RECOMMANDÉ /
 NICHT EMPFOHLEN /
 NO RECOMENDADO /
 NON CONSIGLIATO /
 不建议

Example / Exemple / Biespiel / Ejemplo / Esempio / 例子

	①	➔	②	➔	①
T = 7 h 00		➔		➔	

⚠ ⚠ DANGER / DANGER / GEFAHR / PERICOLO / PELIGRO / 危險

<p>HAZARD OF ELECTRIC SHOCK, EXPLOSION OR ARC FLASH</p> <ul style="list-style-type: none"> • Disconnect all power before servicing equipment. • Confirm that the product power supply voltage and its tolerances are compatible with those of the network. <p>Failure to follow these instructions will result in death or serious injury.</p>	<p>RISQUE D'ELECTROCUTION, D'EXPLOSION OU D'ARC ELECTRIQUE</p> <ul style="list-style-type: none"> • Couper toutes les alimentations avant d'intervenir sur cet appareil. • Assurez-vous que la tension d'alimentation du produit, avec ses tolérances, est compatible avec celle du réseau. <p>Le non-respect de ces instructions entraînera le mort ou des blessures graves.</p>	<p>STROMSCHLAG-, EXPLOSIONS- ODER LICHTBOGENGEFAHR</p> <ul style="list-style-type: none"> • Vor dem Arbeiten an dem Gerät dessen Stromversorgung abschalten. • Stellen Sie sicher, dass die Versorgungsspannung des Produkts einschließlich Toleranzen mit den Netzbedingungen vereinbar ist. <p>Die Nichtbeachtung dieser Anweisungen wird den Tod oder schwere Körperverletzung zur Folge haben.</p>
<p>RIESGO DE ELECTROCUCIÓN, EXPLOSIÓN O ARCO ELÉCTRICO</p> <ul style="list-style-type: none"> • Desconecte toda alimentación antes de realizar el servicio. • Asegúrese de que la tensión de alimentación del producto y sus tolerancias son compatibles con las de la red eléctrica. <p>Si no se siguen estas instrucciones provocará lesiones graves o incluso la muerte.</p>	<p>RISCHIO DI SCOSSA ELETTRICA, DI ESPLOSIONE O DI OFTALMIA DA FLASH</p> <ul style="list-style-type: none"> • Scollegare l'apparecchio dalla presa di corrente prima di qualsiasi intervento. • Assicurarsi che la tensione di alimentazione del prodotto e le relative tolleranze sia compatibile con quelle della rete. <p>Il mancato rispetto di queste istruzioni provocherà morte o gravi infortuni.</p>	<p>存在电击、爆炸或电弧危险</p> <ul style="list-style-type: none"> • 维修设备前，请断开所有电源连接。 • 确认产品电源电压及其公差兼容于网络的这些参数。 <p>不按照上述规定操作会导致严重的人员伤亡。</p>

- (en)** Electrical equipment should be installed, operated, serviced, and maintained only by qualified personnel. No responsibility is assumed by Schneider Electric for any consequences arising out of the use of this material.
- (fr)** Les équipements électriques doivent être installés, exploités et entretenus par un personnel qualifié. Schneider Electric décline toute responsabilité quant aux conséquences de l'utilisation de ce matériel.
- (de)** Elektrische Geräte dürfen nur von Fachpersonal installiert, betrieben, gewartet und instand gesetzt werden. Schneider Electric haftet nicht für Schäden, die aufgrund der Verwendung dieses Materials entstehen.
- (es)** Sólo el personal de servicio cualificado podrá instalar, utilizar, reparar y mantener el equipo eléctrico. Schneider Electric no asume las responsabilidades que pudieran surgir como consecuencia de la utilización de este material.
- (it)** Le apparecchiature elettriche devono essere installate, usate e riparate solo da personale qualificato. Schneider Electric non assume nessuna responsabilità per qualunque conseguenza derivante dall'uso di questo materiale.
- (zh)** 电气设备的安装、操作、维修和维护工作仅限于合格人员执行。对于超出本资料所引发的任何后果，Schneider Electric 概不负责。

Schneider Electric Industries SAS
35, rue Joseph Monier
CS 30323
F - 92506 Rueil-Malmaison Cedex

施耐德电气生产工厂
无锡普洛菲斯电子有限公司
江苏省无锡国家高新技术产业开发区
汉江路20号中国地区客服电话：
+86 400 810 1315

This product must be installed, connected and used in compliance with prevailing standards and/or installation regulations.
As standards, specifications and designs develop from time to time, always ask for confirmation of the information given in this publication.