



Main

Range of product	Harmony XB5
Sale per indivisible quantity	1
Product or component type	Timer

Complementary

Bezel material	Plastic
Fixing collar material	Plastic
Mounting diameter	0.87 in (22 mm)
Panel Thickness	0.24 in (6 mm)
Shape of signaling unit head	Round
Time delay range	0.5...10 min
Time delay type	A
Repeat accuracy	+/- 0.5 %
Setting accuracy of time delay	+/- 10 % of full scale 77 °F (25 °C) EN/IEC 61812-1
Temperature drift	+/- 0.05 %/°C
Voltage drift	+/- 0.2 %/V
Protection type	Reverse polarity protection Overvoltage protection
Output type	Open collector PNP
Temporary permissible current	10 A 0.01 s
Minimum switching current	10 mA
Voltage drop in closed state	3 V
Network type	DC
Residual current in open state	0.1 mA
Maximum power consumption in W	1 W
Reset time	5 Ms after time delay on de-energisation 7 ms during time delay on de-energisation
Local signalling	LED green, flashing timing in progress LED, steady no timing in progress and output relay energised
[Us] rated supply voltage	24 V DC
Supply voltage limits	16.8...31.2 V DC
Output short-circuit protection	With
Connections - terminals	Screw terminals 1 x 4 mm ² EN/IEC 60947-1 Screw terminals 1 x 2.5 mm ² EN/IEC 60947-1
IP degree of protection	Front IP65 IEC 60529 Back IP20 IEC 60529
Ambient air temperature for operation	-4...140 °F (-20...60 °C)
Ambient air temperature for storage	-4...176 °F (-20...80 °C)
Tightening torque	4.43 lbf.in (0.5 N.m)

Dielectric strength	1500 V EN/IEC 61812-1
[Ui] rated insulation voltage	50 V EN 60947-1 50 V IEC 60664-1
[Uimp] rated impulse withstand voltage	4 kV EN 60947-1 4 kV IEC 60664-1
Surge withstand	1 kV, level 2 IEC 61000-4-5
Overvoltage category	Class 3 IEC 60536 Class 3 IEC 60664-1
Pollution degree	3
Vibration resistance	0.15 mm 10...60 Hz)IEC 60068-2-6 2 gn 60...150 Hz)IEC 60068-2-6
Shock resistance	+/- 15 gn 11 ms 6 shocks on each axis)IEC 60068-2-27
Resistance to fast transients	2 kV level 3 IEC 61000-4-4
Electromagnetic compatibility	Electrostatic discharge 6 kV level 3 conforming to IEC 61000-4-2 Electromagnetic emission class B conforming to IEC 55011
Resistance to electromagnetic fields	9.14 V/m (10 V/m) 80 MHz...1 GHz level 3 IEC 61000-4-3 2.74 V/m (3 V/m) 1.4...2 GHz level 3 IEC 61000-4-3 0.91 V/m (1 V/m) 2...2.7 GHz level 3 IEC 61000-4-3
Immunity to radioelectric fields	10 V level 3 EN/IEC 61000-4-6
Disturbance radiated/conducted	Class B EN 50022
Standards	UL 508 EN/IEC 61812-1
Product certifications	CE UL Listed
Height	2.44 in (62 mm)
Diameter	1.14 in (29 mm)
Net Weight	0.06 lb(US) (0.027 kg)
Device presentation	Monolithic product

Ordering and shipping details

Category	00028 - DATA PORTS
Discount Schedule	CS2
GTIN	00785901867760
Nbr. of units in pkg.	1
Package weight(Lbs)	1 lb(US) (0.45 kg)
Returnability	No
Country of origin	FR

Packing Units

Unit Type of Package 1	PCE
Package 1 Height	1.26 in (3.2 cm)
Package 1 width	1.26 in (3.2 cm)
Package 1 Length	2.95 in (7.5 cm)
Unit Type of Package 2	S01
Number of Units in Package 2	24
Package 2 Weight	31.01 oz (879 g)
Package 2 Height	5.91 in (15 cm)
Package 2 width	5.91 in (15 cm)
Package 2 Length	15.75 in (40 cm)

Offer Sustainability

Sustainable offer status	Green Premium product
California proposition 65	WARNING: This product can expose you to chemicals including: Nickel compounds, which is known to the State of California to cause cancer, and Di-isodecyl phthalate (DIDP), which is known to the State of California to cause birth defects or other reproductive harm. For more information go to www.P65Warnings.ca.gov
EU RoHS Directive	Pro-active compliance (Product out of EU RoHS legal scope) EU RoHS Declaration
Mercury free	Yes
RoHS exemption information	Yes
China RoHS Regulation	China RoHS Declaration
Environmental Disclosure	Product Environmental Profile
Circularity Profile	End Of Life Information
WEEE	The product must be disposed on European Union markets following specific waste collection and never end up in rubbish bins.

Dimensions

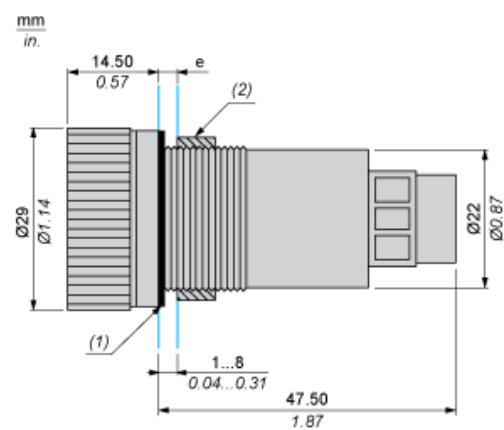

- (e) Clamping thickness: 1 mm to 6 mm / 0.03 in. to 0.24 in.
- (1) Sealing ring
- (2) Screw

Panel Cut-out for Analog Timer (Finished Holes, Ready for Installation)

Connection by Screw Clamp Terminals or Plug-in Connectors

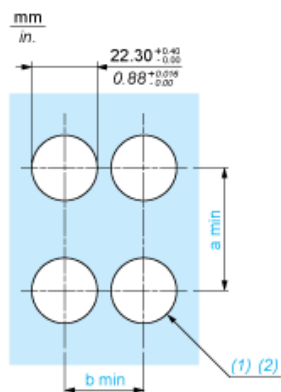

- (1) Diameter on finished panel or support
- (2) Ø22 mm recommended (Ø22.3 0+0.4) / Ø0.89 in. recommended (Ø0.88 in. 0^{+0.016})

Connections	a in mm	a in in.	b in mm	b in in.
By screw clamp terminals or plug-in connector	50	1.97	30	1.18

Wiring Diagram

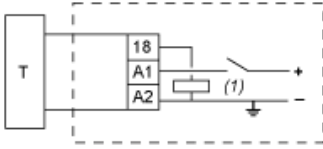

T : Timer
(1) Load
A1 - Supply (24VDC)
A2 :





Function A : On Delay Timer

Description

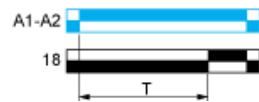
The timing period T begins on energisation with blinking LED indication. After timing, the output (18) closes and LED goes steady

Function: Output



-  De-energised
-  Energised
-  Output open
-  Output closed
- (18) Timed output
- (A1- Supply
- A2)