



Main

Range of product	Phaseo
Product or component type	Battery control module
Input voltage	24...28.8 V DC
Output voltage	(U _{battery} -0.5) V battery mode DC (U _{in} -0.25) V nominal mode DC
Maximum output current	40 A

Complementary

Input voltage limits	22...30 V
Maximum power dissipation in W	12 W
Activation threshold	Adjustable 22...36 V
Number of output channels	1
Current consumption	0.6 A on load 0.1 mA no load ≤ 40.6 A
Output protection type	Against overload 1.5 x I _n Against short-circuits battery-backed mode, automatic reset Against short-circuits power-supplied mode
Connections - terminals	Diagnostic relay removable screw terminal block 1 x 0.75 mm ² Input connection screw type terminals 2 x 0.5...2 x 10 mm ² AWG 20...AWG 8 Output connection screw type terminals 2 x 0.5...2 x 10 mm ² AWG 20...AWG 8
Fixing mode	By clips 35 mm symmetrical DIN rail horizontal By clips 35 mm symmetrical DIN rail vertical
Marking	CE
Name of test	Electrostatic discharges EN/IEC 61000-4-2 Emission EN 61000-6-3 Induced electromagnetic field EN/IEC 61000-4-6 level 3 Radiated electromagnetic field EN/IEC 61000-4-3 level 3 Rapid transient IEC 61000-4-4 level 3 Surge EN/IEC 61000-4-5 level 2 Conducted/radiated emissions EN 55022 Class B, 20 %
Local signalling	For alarm status 1 C/O relay For battery status 1 C/O relay For power supply status 1 C/O relay For module status LCD screen
Net Weight	1.54 lb(US) (0.7 kg)

Environment

Product certifications	RCM EAC
Standards	UL 508 CSA C22.2 No 60950-1
Ambient air temperature for operation	-13...140 °F (-25...60 °C)
Ambient air temperature for storage	-40...185 °F (-40...85 °C)
Environmental characteristic	EMC EN 61000-6-3 EMC EN/IEC 61000-6-2 Safety EN/IEC 60950-1 Safety EN/IEC 61204-3

IP degree of protection	IP20 conforming to EN/IEC 60529
Dielectric strength	500 V between input and ground 500 V between output and ground
Overvoltage category	Class II VDE 0106-1
Relative humidity	0...90 % during operation 0...95 % during storage
MTBF reliability	24 V with UTE C80-810
Vibration resistance	2 gn 11.9...150 Hz)EN/IEC 61131-2 3.5 mm 3...11.9 Hz)EN/IEC 61131-2

Ordering and shipping details

Category	22525 - ABL8 AND ABL7 POWER SUPPLIE
Discount Schedule	CP12
GTIN	00785901637462
Nbr. of units in pkg.	1
Package weight(Lbs)	2.63 lb(US) (1.19 kg)
Returnability	No
Country of origin	PH

Packing Units

Package 1 Height	1.120 dm
Package 1 width	1.800 dm
Package 1 Length	1.850 dm

Offer Sustainability

Sustainable offer status	Green Premium product
California proposition 65	WARNING: This product can expose you to chemicals including: Lead and lead compounds, which is known to the State of California to cause cancer and birth defects or other reproductive harm. For more information go to www.P65Warnings.ca.gov
REACH free of SVHC	Yes
EU RoHS Directive	Pro-active compliance (Product out of EU RoHS legal scope) EU RoHS Declaration
Mercury free	Yes
RoHS exemption information	Yes
China RoHS Regulation	China RoHS Declaration
Environmental Disclosure	Product Environmental Profile
Circularity Profile	End Of Life Information
PVC free	Yes

Contractual warranty

Warranty	18 months
----------	-----------

24 Vdc/40 A Battery Control Module

Dimensions

mm
inch

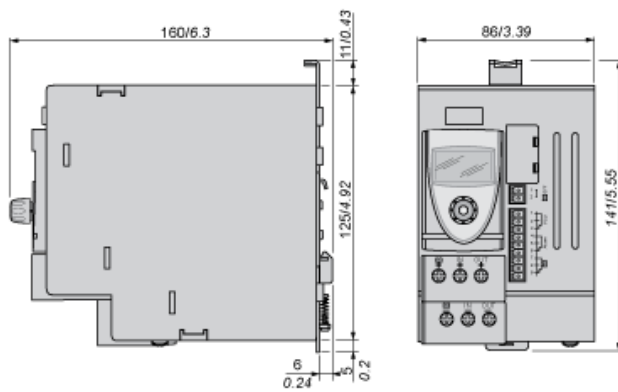

24 Vdc Battery Control Module

Mounting

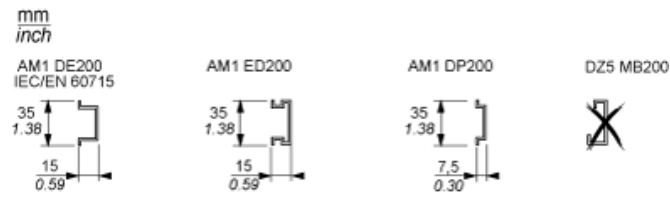

24 Vdc Battery Control Module

Clearance

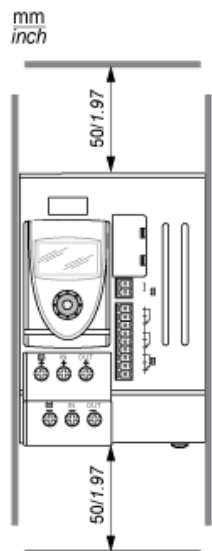

24 Vdc Battery Control Module

Wiring Diagram

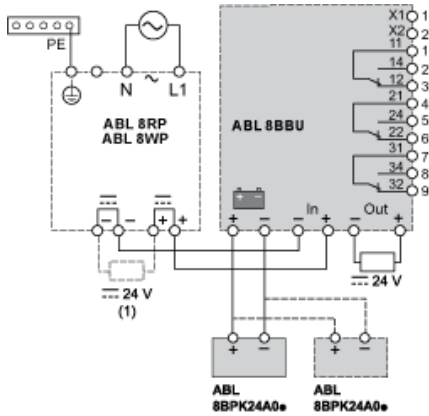

(1) See table below for the maximum unstored charge capacity (µF)

ABL	Max. Unstored Charge Capacity (µF)
8RPS24030	30 000
8RPS24050	50 000
8RPS24100	100 000
8RPM24200	100 000
8WPS24200	100 000
8WPS24400	100 000

24 Vdc Battery Control Module

Outputs States (U = 24 Vdc: I > 5 mA, U = 230 Vac: I < 500 mA)

	No power from the power supply		Power from the power supply
	Alarm or device not supplied		No alarm
	No power from the battery pack		Power from the battery pack







Inputs States (Dry Contact)

	Operational battery		Battery inhibited
--	---------------------	--	-------------------

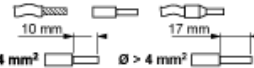
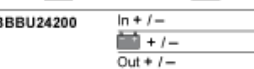





Wiring Requirements

Cable Types and Wire Sizes

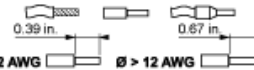
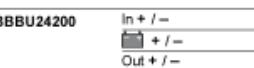
IEC / EN

		ABL 8RPS24030 8RPS24050 8RPS24100	ABL 8RPM24200 8WPS24200 8WPS24400
			
$\varnothing \leq 4 \text{ mm}^2$			
$\varnothing > 4 \text{ mm}^2$			
ABL 8BBU24200	In + / -	1...4 mm ²	4...10 mm ²
	 + / -	6 mm ²	-
	Out + / -	6 mm ²	-
ABL 8BBU24400	In + / -	1...4 mm ²	4...10 mm ²
	 + / -	10 mm ²	-
	Out + / -	10 mm ²	-
	 +	10 mm ²	-
		-	
 OFF / PSU / Alarm / 		0,14...1 mm ²	

UL

		ABL 8RPS24030 8RPS24050 8RPS24100	ABL 8RPM24200 8WPS24200 8WPS24400
			
$\varnothing \leq 12 \text{ AWG}$			
$\varnothing > 12 \text{ AWG}$			
ABL 8BBU24200	In + / -	16...12 AWG	12...6 AWG
	 + / -	10 AWG	-
	Out + / -	10 AWG	-
ABL 8BBU24400	In + / -	16...12 AWG	12...6 AWG
	 + / -	6 AWG	-
	Out + / -	6 AWG	-
	 +	6 AWG	-
		-	
 OFF / PSU / Alarm / 		26...16 AWG	