



MONARCH INSTRUMENT

Instruction Manual

PALM STROBE x **Pocket-Sized Portable Stroboscope**



15 Columbia Drive

Amherst, NH 03031 USA

Phone: (603) 883-3390 • Fax: (603) 886-3300

E-mail: support@monarchinstrument.com

Website: www.monarchinstrument.com



SAFEGUARDS AND PRECAUTIONS



1. Read and follow all instructions in this manual carefully, and retain this manual for future reference.
2. Do not use this instrument in any manner inconsistent with these operating instructions or under any conditions that exceed the environmental specifications stated.
3. Certain strobe frequencies can trigger epileptic seizures in those prone to that type of attack.
4. User should not stare directly at the light source.
5. Prolonged exposure to the light can cause headaches in some people.
6. Objects viewed with this product may appear to be stationary when in fact they are moving at high speeds. Always keep a safe distance from moving machinery and do not touch the target.
7. There are lethal voltages present inside this product. Refer to the section on Lamp Replacement before attempting to open this product.
8. Do not allow liquids or metallic objects to enter the ventilation holes on the stroboscope as this may cause permanent damage and void the warranty.
9. Do not allow cables extending from the unit to come into contact with rotating machinery, as serious damage to the equipment, or severe personal injury or death may occur as a result.
10. This instrument may not be safe for use in certain hazardous environments, and serious personal injury or death could occur as a result of improper use. Please refer to your facility's safety program for proper precautions.
11. This product contains nickel-metal hydride batteries which must be disposed of in accordance with Federal, State and Local Regulations. Do not incinerate. Batteries should be shipped to a reclamation facility for recovery of the metal and plastic components as the proper method of waste management. Refer to section 7.3 of this manual, and contact your distributor for appropriate product return procedures.
12. This instrument is not user serviceable. For technical assistance, contact the sales organization from which you purchased the product or Monarch Instrument directly.

TABLE OF CONTENTS:

1.0 DESCRIPTION	1
1.1 Display Panel	2
2.0 PREPARATION FOR USE	2
2.1 Power	3
2.2 Input/Output Connections	3
3.0 OPERATION	4
3.1 Internal Mode - Standard Strobe Operation	5
3.2 External Input Mode	7
3.3 Tach Mode (No Flash) – External Input Required	7
4.0 USING THE STROBOSCOPE TO MEASURE RPM	7
5.0 LAMP REPLACEMENT	9
6.0 BATTERY PACK	11
6.1 Low Battery Indication	12
6.2 Charging the Battery Pack	13
6.3 Battery Disposal	14
7.0 SPECIFICATIONS	15
7.1 Compliance	17
8.0 SENSORS/ACCESSORIES AND PARTS	18



In order to comply with EU Directive 2012/19/EU on Waste Electrical and Electronic Equipment (WEEE): This product may contain material which could be hazardous to human health and the environment. **DO NOT DISPOSE** of this product as unsorted municipal waste. This product needs to be **RECYCLED** in accordance with local regulations; contact your local authorities for more information. This product may be returnable to your distributor for recycling; contact the distributor for details.

Monarch Instrument's Limited Warranty applies.
See www.monarchinstrument.com for details.

Warranty Registration and Extended Warranty Coverage information is available online at www.monarchinstrument.com.

1.0 DESCRIPTION

The PALM STROBE x is a sophisticated stroboscope with many features, yet remains simple to operate. It is a pocket-size, lightweight, industrial strength, single-handed operation instrument that fits in the palm of your hand. A four-quadrant Tuner Button adjusts the flash rate, and provides multiply/divide by 2 functions. A large, bright, backlit, 6-digit alphanumeric LCD shows the flash rate and mode of operation. The strobe can store and recall eight programmable flash rate settings and the last used setting in nonvolatile memory, so that the unit “remembers” all the flash rates when the power is turned off.

The strobe has a removable, rechargeable battery pack which provides up to 2 hours of continuous use depending on the flash rate. This battery pack clips in and out with no tools required. An optional second battery pack allows for longer operation in the field. A ¼-20 UNC thread bushing on the underside of the strobe allows for tripod mounting. The strobe locks “ON” for hands-free operation.

The Input/Output phone jack will accept an external input up to the maximum FPM and can be used with an external Self-Powered Sensor to measure RPM. The Input/Output phone jack will also provide TTL output pulses for each flash.

This product protected by U.S.A. Patents D492,805 and 6,945,666.

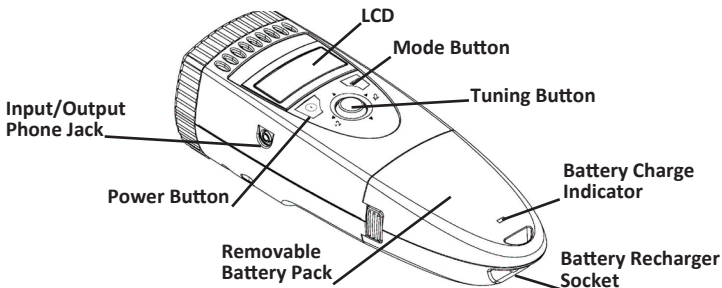

Figure 1 PALM STROBE x

1.1 Display Panel

The display panel consists of a backlit, liquid crystal display with six alphanumeric digits which indicate modes, flash rates, etc.

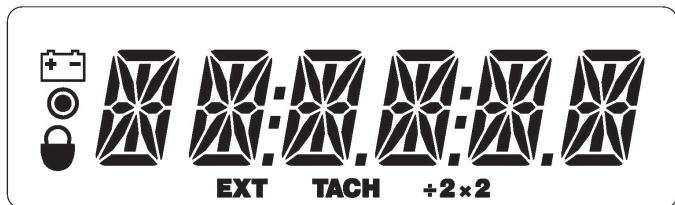



Figure 2 Display Panel

Other icons or messages in the display indicate the following:

 **Battery icon:** displayed when the battery is getting low. There is protection circuitry in the unit that will prevent the battery from being over discharged or prevent the unit from being operated with a low battery.

 **On-Target Indicator:** for Tachometer Mode and Remote Sensor in External Input Mode

 **Lock icon:** shown to indicate that the strobe is locked on

EXT External Input Mode: displays when mode is activated

TACH Tachometer Mode: displays when mode is activated

÷2 x2 Divide/Multiply by 2: when this icon is shown, rocking the tuning button to the left will divide the current flash rate by two and rocking the tuning button to the right will multiply the current flash rate by two.

2.0 PREPARATION FOR USE

PALM STROBE x may be hand held or mounted on a tripod or other user supplied bracket using the ¼-20 UNC bushing in the base of the unit.

2.1 Power

PALM STROBE x has a removable Nickel-Metal Hydride (NiMH) Battery Pack that clips in and out of the main strobe housing. The Battery Pack should be charged before use (see [Section 6.0](#)). The strobe has a protection feature that prevents the strobe from operating if the battery voltage is low. This condition is indicated by no flash and the Low Battery icon () will be displayed (see [Section 6.1](#)). At this time, the battery pack must be recharged or exchanged for a fully charged battery pack. The actual operating time of the stroboscope depends on the flash rate and duty cycle of operation. Slower flash rates increase the operating time.

2.2 Input/Output Connections

PALM STROBE x has a TTL Input/Output phone jack on the side of the stroboscope. This jack accepts a 1/8 inch [3.5 mm] stereo phone plug and can be used for external triggering or synchronization of the stroboscope or for providing a TTL pulse output, synchronous with the flash.

The jack's outer connection (barrel) is common, the inner or center connection is the signal, and the tip is the pulse output (see Figure 3). The input and output are TTL compatible.

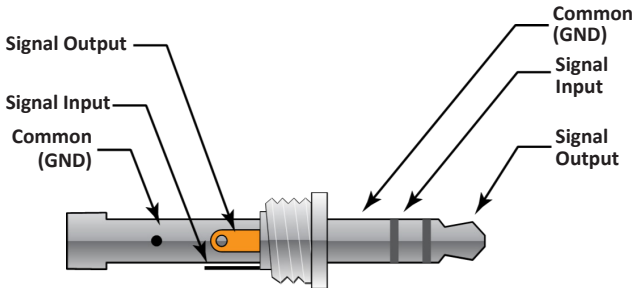

Figure 3 Input/Output Connector Detail

With no external input the strobe provides a TTL compatible pulse output from the strobe's internal oscillator. If an external input is applied, the output pulse mimics the input pulse. The jack has no voltage output for a sensor.

3.0 OPERATION

To turn on the stroboscope, press and release the On/Off button (ⓘ). Press and release the On/Off button (ⓘ) again to turn the strobe off.

When the strobe is powered up, it will begin flashing immediately at the last internal flash rate displayed. The last digit changed will flash for 5 seconds allowing the digit to be changed again. Rock the tuning button up or down to change the flashing digit. Rock the tuning button left or right to select a different digit to change.

The flash rate is displayed on the LCD in flashes per minute, which typically is the same as RPM.

The PALM STROBE x has three primary operating modes (Internal, External Input and Tach) and three functions ($\div 2 \times 2$, Recall and Store) that are adjusted by the MODE button. By default, the strobe powers up in the Internal Mode. Pressing the MODE button will change the mode/function in the following order: $\div 2 \times 2$, Recall, Store, External, Tach, Internal. The $\div 2 \times 2$, Recall and Store functions are only applicable to the Internal Mode.

In the **Internal Mode**, the tuner button adjusts the flash rate from the minimum to the maximum number of Flashes Per Minute (FPM or RPM). In the **External Input Mode**, an external signal from another strobe or a remote self-powered sensor is used to trigger the flash and the tuner button has no effect. In the **Tach Mode** the unit will not flash, but will display the input from an external (self-powered) sensor as RPM up to 250,000 RPM.

3.1 Internal Mode - Standard Strobe Operation

In the **Internal Mode** the stroboscope generates it's own frequency variable speed signals and functions like a typical stroboscope. This is the default start up mode.

The rubber tuning button functions as a joystick. The tuning button is sensitive in four directions. Place your thumb on the button and use a rocking motion (forward, back, or side-to-side) to control it (see Figure 4). It is possible to adjust the strobe in 0.1 FPM increments.

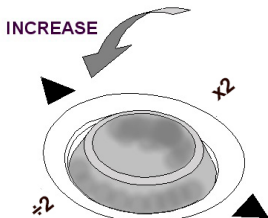

Figure 4 Tuning Button

To change the flash rate:

1. Press the tuning button. The last digit changed will begin blinking.
2. Rock the tuning button to the left or right to select which digit to change. The digit blinking is the one to be changed.
3. Rock the tuning button up or down to increase or decrease the value of the blinking digit. The digit will stop blinking after 5 blinks and the strobe will continue to flash at the new flash rate.

To multiply or divide the current flash rate by 2:

1. Press the MODE button once. The $\div 2 \times 2$ icon will be displayed.
2. Rock the tuning button to the left for $\div 2$ or right for $\times 2$. (Rocking the tuning button up or down while in the $\div 2 \times 2$ Mode will have no effect.)
3. Repeat steps 1 and 2 each time you want to multiply or divide the flash rate.

Note: If a multiply or divide operation will exceed the limits of the unit, upper limit or lower limit, the display will indicate OVER or UNDER and no change will be made to the flash rate.

To select a flash rate from a Preset (memory) location:

1. Press the MODE button once. The $\div 2 \times 2$ icon will be displayed.
2. Press the MODE button again (without pressing the rubber tuning button in between). "RECALL" will be displayed.
3. Rock the tuning button up or down to select a preset flash rate. The display will show "R MEMX", where X=the present location (1-8), and then display the flash rate saved in that location and begin flashing at the specified flash rate with each press of the button.
4. Press the MODE button to return to the Internal Mode using the selected flash rate.

To store the current flash rate in a Preset (memory) location:

1. Press the MODE button once. The $\div 2 \times 2$ icon will be displayed.
2. Press the MODE button a second time (without pressing the rubber tuning button in between). "RECALL" will be displayed.
3. Press the MODE button again (without pressing the rubber tuning button in between). "STORE" will be displayed.
4. Rock the tuning button up or down to select the location in which to store the current flash rate. The display will show "S MEMX", where X=the present location (1-8), and then display the flash rate saved in that location.
5. Once you have selected a preset location to overwrite, press the MODE button to save the current flash rate in that location. "SAVING" will be displayed and then you will return to the Internal Mode.

3.2 External Input Mode

Press the MODE button (without pressing the tuning button in between) until the **EXT** icon is displayed. An external input is required (TTL compatible source from a self-powered sensor).

In the **External Input Mode** there are no flash rate adjustments the user can make. The flash rate is triggered by the TTL input signal. This mode is used to synchronize the flash to an external event (for example, from an optical sensor) to stop or freeze motion for timing studies or balancing machines. The flash will be triggered on the rising edge of the external input pulse.

The maximum input is 12,500 FPM, above which the strobe will no longer flash.

3.3 Tach Mode (No Flash) – External Input Required

Press the MODE button (without pressing the tuning button in between) until the **TACH** icon is displayed. In the **Tachometer Mode**, the unit will read the signal from the external input (self-powered sensor) and display the reading on the LCD, without flashing the lamp. The strobe can read up to 250,000 RPM in this mode.

4.0 USING THE STROBOSCOPE TO MEASURE RPM

The primary use for a stroboscope is to stop motion for diagnostic inspection purposes. However, the stroboscope can also be used to measure speed. In order to do this, several factors need to be considered. First, the object being measured should be visible for all 360° of rotation (e.g. the end of a shaft). Second, the object should have some unique part on it, like a bolt, keyway or imperfection to use as a reference point. If the object being viewed is perfectly symmetrical, then the user needs to mark the object with a piece of tape or paint in a single location, while the object is stationary, to be used as a reference point. **Look only at the reference point.**

If the speed of rotation is within the range of the stroboscope, start at the highest flash rate and adjust the flash rate down. At some point you will stop the motion with only a single reference point of the object in view. Note that at a flash rate twice the actual speed of the image you will see two images (reference points). As you approach the correct speed you may see three, four or more images at harmonics of the actual speed. The first SINGLE image you see is the true speed. To confirm the true speed, note the reading and adjust the stroboscope to exactly half this reading, or just press the left of the joystick button for the $\div 2$ function. You should again see a single image (which may be phase shifted with respect to the first image seen).

For example, when viewing a shaft with a single keyway, you will see one stationary image of the keyway at the actual speed and at $1/2, 1/3, 1/4$, etc, of the actual speed. You will see 2 images of the keyway at 2 times the actual speed, 3 keyway images at 3 times, etc. (see Figure 5). **The Flash Per Minute (FPM) equals the shaft's Revolutions Per Minute (RPM) at the highest flash rate that gives only one stationary image of the keyway.**



Figure 5 Object Rotating at 3000 RPM

If the speed is outside the full scale range of the stroboscope (12,500 FPM), it can be measured using the method of harmonics and multipoint calculation. Start at the highest flash rate and adjust the flash rate down. Be aware that you will encounter multiple images. Note the flash rate of the first SINGLE image you encounter, and call this speed "A". Continue decreasing the flash rate until you encounter a second SINGLE image, and note this speed as "B". Continue decreasing the speed until you reach a third SINGLE image at speed "C".

For a two-point calculation, the actual speed is given by: $RPM = AB/(A-B)$

For a three-point calculation: $RPM = 2XY(X+Y)/(X-Y)^2$ where

$$X = (A-B) \text{ and}$$

$$Y = (B-C)$$

If a self-powered sensor is used to sense one pulse per revolution (External Input Mode), the readout will display directly in RPM (FPM) without any adjustment required.

In instances when you can shut down the device and install a piece of reflective tape, then an optical tachometer is easier to use for RPM measurement. You can use the PALM STROBE x with an external sensor as an optical tachometer. **Stroboscopes need only be used as a tachometer when you can't shut down the device.** The human eye is not easily tricked into seeing a stopped image by a stroboscope when the flash rate is slower than 300 FPM. Therefore, a stroboscope image is difficult to use below 300 FPM for inspection or to measure RPM.

5.0 LAMP REPLACEMENT



WARNING: Before attempting to remove the lamp, make sure the stroboscope is turned off and remove the Battery Pack (see [Section 6.0](#)). Allow the lamp to cool, waiting at least 5 minutes.

The stroboscope is designed to discharge the internal high voltages within 30 seconds. However, caution should be exercised when replacing the lamp.

To change the lamp:

1. To gain access to the lamp, it is only necessary to remove the front lens, which is held in place by the rubber bumper. Pry the rubber bumper off the end of the unit. The reflector is held in place by the front lens and will come loose, but it is not necessary to remove the reflector.

2. Hold the lamp with a cloth between your forefinger and thumb and rock it back and forth gently while pulling out. Do not attempt to rotate the lamp. The lamp is socketed and will come out easily when pulled straight out.



WARNING: Do NOT touch the new lamp with bare fingers.

3. Using a lint-free cloth, insert the new lamp by gently rocking the lamp while pushing it into place (see Figure 6). Make sure the lamp is in straight and centered in the reflector hole.

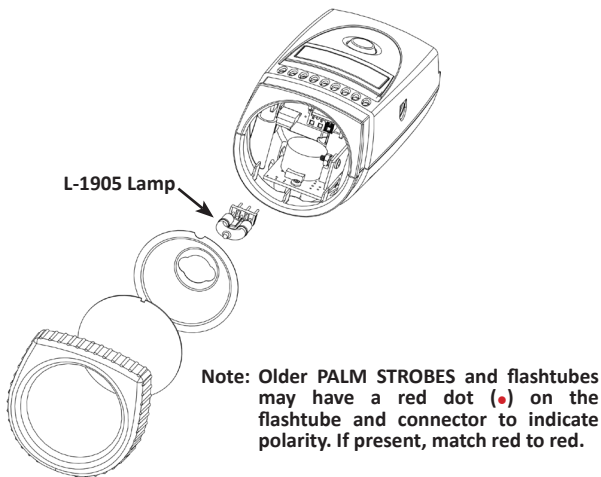

Figure 6 Lamp Replacement

4. Reinstall the reflector (if necessary) and then position the front lens in place matching up the notches on the lens with the two small tabs on the housing to prevent lens rotation (see Figure 6). Stretch the rubber bumper over the top and bottom case halves to seal in the reflector and front lens.

6.0 BATTERY PACK

The PALM STROBE x Battery Pack is fitted with rechargeable NiMH (nickel-metal hydride) batteries. These batteries contain fewer toxic metals than Ni-Cd (nickel-cadmium) and are currently classified “environmentally friendly”. They also have 30% more capacity than Ni-Cd batteries of the same size.

Like Ni-Cds, **NiMH batteries are prone to self-discharge** - 10 to 15% of charge is lost in the first 24 hours then continues at a rate of 0.5 to 1% per day. For maximum performance, charge the batteries just prior to use.

When not in use, the batteries should be charged at least every three months, otherwise the battery capacity will be reduced or the batteries may become unusable.

Charge the batteries before use and allow 3-5 cycles of charging and discharging for batteries to reach full capacity.

The enclosure contains control electronics to properly and safely charge the batteries. Never remove the batteries from the enclosure and attempt to charge externally. **Always use the charger supplied (PSC-2U).**

The PALM STROBE x Battery Pack can be removed by pressing the two latches on either side of the unit while gently pulling the Battery Pack outwards (see Figure 7). To install the Battery Pack, slide it into the strobe until you hear the side latches engage and lock. Match the top and bottom colors when inserting the Battery Pack into the strobe. The Battery Pack is keyed so that it cannot be inserted into the strobe upside down.



CAUTION: The terminals on the Battery Pack are recessed. DO NOT SHORT THESE CONNECTIONS. There is a non-serviceable internal resettable fuse for protection.

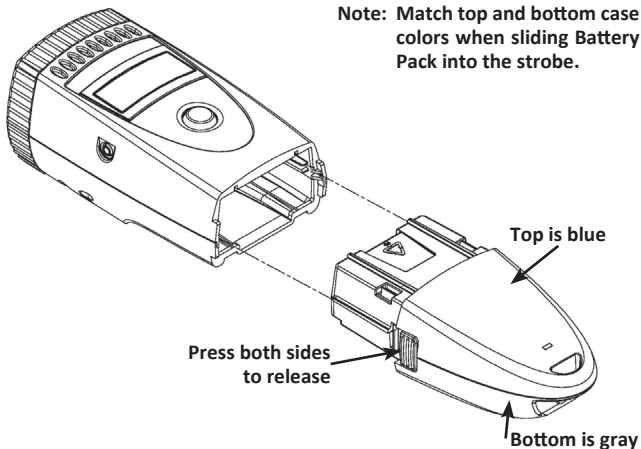





Figure 7 Battery Pack Removal/Installation

6.1 Low Battery Indication

When the batteries are low, the Low Battery icon () is displayed. The strobe may still be used for a short time. When the battery charge is further depleted, the strobe will stop flashing, the Low Battery icon () will be displayed, and then the strobe will completely shut off. When the Low Battery icon () is displayed, the Battery Pack needs to be recharged (see [Section 6.2](#)).

Note: If the batteries are discharged you will not be able to run the unit. The unit may not start at all, or the Low Battery icon () may be displayed and then the strobe will shut off. Recharge the Battery Pack or replace it with a fully charged unit.

6.2 Charging the Battery Pack

The Battery Pack may be recharged at any time. You do not need to wait until the low battery condition is indicated. The Battery Pack does not need to be in the strobe for charging.

To charge the Battery Pack:

1. Make sure the strobe is off or remove the Battery Pack from the strobe.
2. Plug the recharger cable into the battery recharger socket on the Battery Pack (see [Figure 1](#) for location).
3. Plug the recharger into an AC mains wall outlet.

Note: When using the Universal recharger, make sure the correct adapter plug is inserted into the recharger before plugging the recharger into the wall outlet.



CAUTION: Use of rechargers other than the one supplied (PSC-2U) may damage the stroboscope and void the warranty.

The battery module contains circuitry to control the charge. The amber LED blinks steady to indicate that the battery is being charged. The LED will turn solid amber as it nears complete charge. Once the charge is completed, the LED turns solid green and the recharger will trickle charge the battery. The Battery Pack may be used at this point.

Note: The total charge time is typically about 4-5 hours. The Battery Pack may be left on trickle charge indefinitely.

The LED also indicates that charging has stopped due to a problem. The LED will blink 5, 6, 7, or 8 short red blinks and then one long green blink to indicate the following: 5 = over voltage, 6 = over current, 7 = too hot, and 8 = too cold.

6.3 Battery Disposal

Prior to disposing of the Battery Pack, the user must remove the nickel-metal hydride batteries. To do this, remove the four screws on the under side of the Battery Pack and separate the case halves, exposing the battery. Remove the cables from the battery and place tape over the battery terminals to prevent them from shorting. The battery should be sent to a recycling center or returned to the factory. The rest of the parts may now be disposed of.

7.0 SPECIFICATIONS

Specifications*	PALM STROBE x
Internal Mode:	
Flash Range	100 - 12,500 FPM (Flashes per Minute)
Flash Rate Accuracy	The greater of ± 0.5 FPM or $\pm 0.01\%$ of reading
Flash Rate Resolution (Setting)	0.1 FPM
Display Update Rate	Continuous
External/Tachometer Mode:	
Flash Range and Display	5.0 to 12,500 FPM - External flash rates to 0 are acceptable
Tachometer Measurements	5 to 250,000 RPM - No flash
Accuracy	The greater of ± 0.1 FPM or $\pm 0.01\%$ of reading
Display Update Rate	1 second typical
Trigger to Flash Delay	$< 5 \mu\text{sec}$
External Input	0 to 5 V TTL Compatible (12 V pk max) $1 \mu\text{sec}$ min pulse width; Positive edge triggered
Time Base	
Time Base	Stable crystal oscillator
Display	
Display	6-digit alphanumeric backlit LCD with 0.3 inch [7.62 mm] high digits
Indicators	
Indicators	Low Battery, On-Target Indicator, Locked On, External Mode, Tachometer Mode, $\div 2 \times 2$
Adjustment	
Adjustment	Four Quadrant Tuner Button with decade select for flash rate up or down, multiply by 2 and divide by 2

Specifications*	PALM STROBE x
Memory	Saves eight programmable flash rates and last flash rate at power down
Output Pulse	350 μ sec positive pulse, 5 V dc typical
Power	Removable 6 V dc Rechargeable Battery Pack with Integral Electronics Charge Control for rechargers (PSC-2U Recharger: 9 V dc @ 500mA)
Light Power	150 mJ/Flash up to 3000 FPM, 7.9 Watts @ 6000 FPM
Flash Duration	10 - 30 microseconds typical
Run Time	2 hours at 1800 FPM and 1 hour at 6000 FPM typical with fully charged batteries
Charge Time	About 4 hours
Weight	1.2 lbs (544 g) including Battery Pack
Dimensions LxWxH	9.34 in. x 3.20 in. x 3.04 in. [237.34 mm x 81.20 mm x 77.16 mm]

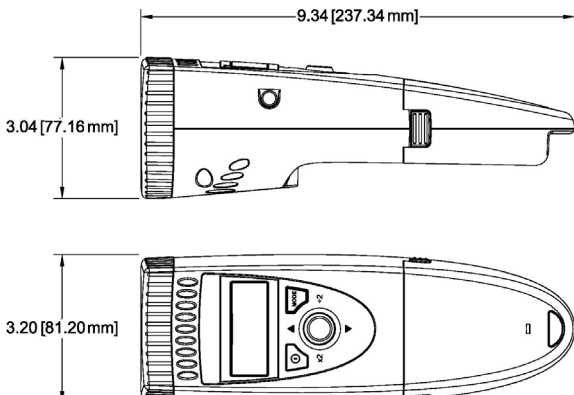

Figure 8 Dimensions in inches [mm]

Specifications*	PALM STROBE x
Safety	This product is designed to be safe for indoor use under the following conditions (per IEC61010-1):
Operating Temperature	32-104 °F (0-40 °C)
Humidity	Maximum relative humidity 80% for temperature up to 88 °F (31 °C) decreasing linearly to 50% relative humidity at 104 °F (40 °C)

*Specifications are subject to change without notice.

7.1 Compliance

- **CE compliant**
- Low Voltage Directive (LVD) 2014/35/EU
- Electromagnetic Compatibility Directive (EMC) 2014/30/EU
- Restriction of Hazardous Substances (RoHS) Directive 2011/65/EU

8.0 SENSORS/ACCESSORIES AND PARTS

[See Accessories webpage for details.](#)

Accessories:

PN	Model	Description
6150-020	SPSR-115/230	Self-Powered Sensor for TTL trigger input or Tachometer mode operation; includes SPSR-U Universal power/recharger, ROS-P optical sensor with 8 ft cable, and 12 inches of T-5 Reflective Tape
6280-032	Pulse Input Cable	TTL Pulse Input Cable, 6 ft. [1.82 m], 1/8" stereo plug to BNC connector; for use with the SPSR Self-Powered Sensor
6280-037	Input/Output Cable CA-4044-6	TTL Pulse Output Cable, 6 ft. [1.82 m], 1/8" mono plug to BNC connector; for use with PLT200 Tachometer and stroboscopes
6280-043	PALM STROBE Holster	Holster with belt loop for fit with utility belt, features pouch for spare battery (included with PALM STROBE x Pak 115/230 and PALM STROBE x Deluxe Kit 115/230)
6280-042	CC-9	Latching Carrying Case with provision for accessories (included with PALM STROBE x Kits)
6180-040	Mini Tripod	Miniature tripod with 1/4" x 20 threaded stud
6180-070	T-5 Tape	Reflective tape - 5 ft. [1.5 m] roll, 0.5 inch [12.7 mm] wide

Compatible Remote Sensors:

PALM STROBE x is compatible with all Monarch sensors with 1/8" phone plug termination ("-P" models). Visit <https://monarchinstrument.com/collections/remote-sensors> for a full listing.



SPSR Self-Power Sensor
PN: 6150-020



Pulse Input Cable
PN: 6280-032



Input/Output Cable
PN: 6280-037



PALM STROBE x Holster
PN: 6280-043



CC-9
PN: 6280-042



Mini Tripod
PN: 6280-040

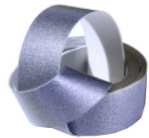

T-5 Reflective Tape
PN: 6180-070

Replacement Parts:

PN	Model	Description
6280-026	Rechargeable Battery Pack	Rechargeable NiMH battery pack; US Patent 6,945,666
6280-022	PSC-2U	Universal recharger, 115/230 V ac with USA, UK, AUS, and Euro adapter plugs
6280-028	L-1905	Replacement xenon lamp (2-pack)



Rechargeable Battery Pack

PN: 6280-026



PSC-2U Universal Recharger

PN: 6280-022



L-1905 Replacement Xenon Lamp

PN: 6280-028

The Professional's Choice

Monarch Instrument is committed to excellence and quality in manufacturing, sales, and service.



Portable
Tachometers



Track-It™ Data Loggers



Panel Tachometers



Fixed Mounted
Strobes



Portable Strobes



Frequency
Converters



Speed Sensors



DataChart™ Paperless
Recorders



MONARCH
INSTRUMENT

15 Columbia Drive, Amherst NH 03031 USA

Tel.: (603) 883-3390 // Fax: (603) 886-3390

Email: support@monarchinstrument.com

Website: www.monarchinstrument.com