



A8x Outdoor Dome Series Hardware Manual

A81, A82



Table of Contents

Precautions 4

Safety Instructions	6
---------------------------	---

Introduction 7

The List of Models	7
Package Contents.....	8
Physical Description	9
Mounting Options	11

Installing the Camera on a Surface 12

Step 1: Drill the Holes.....	12
Step 2: Prepare the Camera.....	13
Step 3: Waterproof the Cable Connection	14
Option 1: Cable Passing Through the Surface and Bottom Cable Hole	14
Option 2: Cable Passing Along the Surface and the Camera Side Cable Hole.....	17
Step 4: Connect to Network.....	25
Step 5: Access the Camera Live View.....	25
Step 6: Adjust the Viewing Angle	25
Step 7: Close the Dome Cover.....	26

Other Connections..... 27

Connecting a Power Adapter (Optional)	27
Connecting Input / Output Devices (Optional)	28
How to Connect DI/DO Devices	28

How to Connect Audio Input / Output Devices 30
How to Connect a Video Output Device 31

Other Accessories 32

How to Install / Remove the Memory Card 32
 How to Insert the Memory Card 32
 How to Remove the Memory Card 32
How to Attach the RJ-45 Connector 33

Accessing the Camera 35

Configure the IP Addresses 35
Access the Camera 39

Precautions

Read these instructions

You should read all the safety and operating instructions before using this product.

Heed all warnings

You must adhere to all the warnings on the product and in the instruction manual. Failure to follow the safety instruction given may directly endanger people, cause damage to the system or to other equipment.

Servicing

Do not attempt to service this video device yourself as opening or removing covers may expose you to dangerous voltage or other hazards. Refer all servicing to qualified service personnel.

Trademarks

All names used in this manual are probably registered trademarks of respective companies.

Liability

Every reasonable care has been taken during the writing of this manual. Please inform your local office if you find any inaccuracies or omissions. We cannot be held responsible for any typographical or technical errors and reserve the right to make changes to the product and manuals without prior notice.

Federal Communications Commission Statement



This equipment has been tested and found to comply with the limits for a class B digital device, pursuant to Part 15 of the FCC Rules. These limits are designed to provide reasonable protection against harmful interference in a residential installation. This equipment generates, uses, and can radiate radio frequency energy and, if not installed and used in accordance with the instructions, may cause harmful interference to radio communications. However, there is no guarantee that interference will not occur in a particular installation. If this equipment does cause harmful interference to radio or television reception, which can be determined by turning the equipment off and on, the user is encouraged to try to correct the interference by one or more of the following measures:

- Reorient or relocate the receiving antenna.
- Increase the separation between the equipment and receiver.
- Connect the equipment into an outlet on a circuit different from that to which the receiver is connected.
- Consult the dealer or an experienced radio/TV technician for help.

Warning: Changes or modifications to the equipment that are not expressly approved by the responsible party for compliance could void the user's authority to operate the equipment.

European Community Compliance Statement



This product has been tested and found to comply with the limits for Class B Information Technology Equipment according to European Standard EN 55022 and EN 55024. In a domestic environment, this product may cause radio interference in which cause the user may be required to take adequate measures.

Safety Instructions

Cleaning

Disconnect this video product from the power supply before cleaning.

Attachments

Do not use attachments not recommended by the video product manufacturer as they may cause hazards.

Do not use accessories not recommended by the manufacturer

Install the PoE switch or injector and other devices that will be used with the camera in a dry place protected from weather.

Servicing

Do not attempt to service this video product yourself. Refer all servicing to qualified service personnel.

Damage Requiring service

Disconnect this video product from the power supply immediately and refer servicing to qualified service personnel under the following conditions.

- 1) When the power-supply cord or plug is damaged
- 2) If liquid has been spilled, or objects have fallen into the video product.
- 3) If the inner parts of video product have been directly exposed to rain or water.
- 4) If the video product does not operate normally by following the operating Instructions in this manual. Adjust only those controls that are covered by the instruction manual, as an improper adjustment of other controls may result in damage, and will often require extensive work by a qualified technician to restore the video product to its normal operation.



Safety Check

Upon completion of any service or repairs to this video product, ask the service technician to perform safety checks to determine if the video product is in proper operating condition.

Introduction

The List of Models

This hardware manual contains the following models:

A81		3MP Outdoor Zoom Dome with D/N, Adaptive IR, Extreme WDR, SLLS, 4.3x Zoom lens
A82		5MP Outdoor Zoom Dome with D/N, Adaptive IR, Extreme WDR, SLLS, 2.8x Zoom lens

Package Contents

<p>Camera</p> 	<p>Mounting Screws</p> 	<p>Allen Wrench</p> 
<p>Metal Cap</p> 	<p>Conduit Gland</p> 	<p>Cable Gland</p> 
<p>Rubber</p> 	<p>Drill Template</p> 	<p>Quick Installation Guide</p> 
<p>Warranty Card</p>		
		

Physical Description

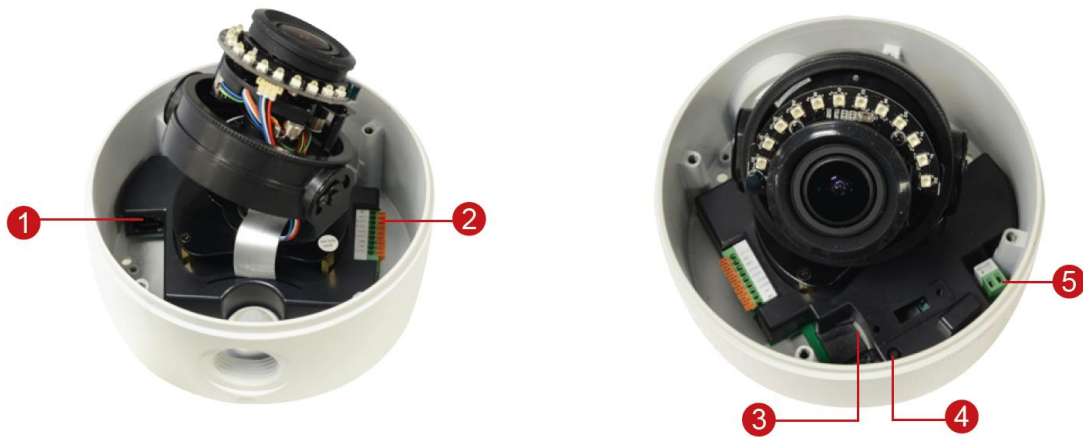



NOTE: The camera picture above is for reference only. Actual camera may slightly differ.

	Item	Description
1	Ethernet Port	Connects to a network using an Ethernet cable. There are two (2) LED indicators on the port: <ul style="list-style-type: none"> • Power LED (Amber): Lights up when power is connected. • LAN LED (Green): Blinks when network activity is in progress.
2	Terminal Block Connector	
	Audio Input / Output	Connects to an audio input and output device, such as a microphone and speaker. See How to Connect Audio Input / Output Devices on page 30 for more information.
	Digital Input / Output	Connects to digital input or output devices, such as an alarm trigger, panic button, etc., as well as audio input and output devices, such as microphones and speakers. Digital Input (DI) and Digital Output (DO) devices are used in applications like motion detection, event alarm notifications, etc. See How to Connect DI/DO Devices on page 28 for more information.
	Video Output	Connects to a video output device, such as a camera installation kit, for camera adjustments on the installation site. See How to Connect a Video

Item	Description
3	Memory Card Slot Insert a memory card into this slot for local recording purposes. See How to Install / Remove the Memory Card on page 32 for more information. NOTE: Supports microSDHC and microSDXC cards.
4	Reset Button Restores the factory default settings of the camera. To reset the camera, while the power is off, press and hold the Reset Button until the Amber LED, on the Ethernet port, lights up.
5	DC 12V Power Input In case the camera is connected to a non-PoE (Power over Ethernet) switch, use this connector to connect the camera to an external power adapter (not included). See Connecting a Power Adapter (Optional) on page 27 for more information.

Mounting Options

There are several mounting options that you can use to install the camera. Select the most suitable solution for your installation environment.

Mount Types	Accessories
Surface Mount	Suitable when mounting the camera directly walls or ceilings without extra accessories. See Installing the Camera on a Surface on page 12 for mounting instructions.
Straight Wall Mount	Suitable when mounting the camera on straight walls.
	PMAX-0333 (Wall Mount) 
Pendant Mount	Suitable when mounting the camera on hard and high ceilings.
	PMAX-0113 (Pendant Mount) 

NOTE:

- For more information about the mounting solutions and accessories, please check the [Mounting Accessory Selector](http://www.acti.com/mountingselector) in our website (<http://www.acti.com/mountingselector>).
- The above mounting accessories are not included in the package. Contact your sales agents to purchase.

Installing the Camera on a Surface

This section describes the procedures in installing the camera on a flat surface such as a hard or dropped ceiling and straight or tilted walls. Before installation, make sure the wall or ceiling can bear more than the weight of the camera.

Step 1: Drill the Holes

Before drilling the holes, note the direction of the connectors side of the camera, which is also the opposite side of the camera logo. This influences the camera placement and where you should drill the hole where the cables will pass through or how the cables will go along the ceiling or wall.

1. According to the preferred camera orientation, mark the screw holes location on the surface.
2. Determine how the cables will be routed: **pass through the surface** or **along the surface**.
 - **If the cables will pass through the surface**, drill the cable hole and the three (3) screw holes on the surface.

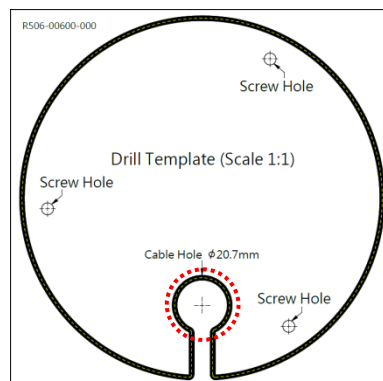

- **If the cables will be routed along the surface**, just drill the three (3) screw holes on the surface.
3. Insert the plastic plugs into the screw holes, if necessary.

Step 2: Prepare the Camera

NOTE: To avoid scratches or leaving fingerprints on the dome cover, it is recommended to retain the plastic covering the dome cover until the camera is completely installed. However, the plastic has been removed on the pictures in this documentation to show clarity of the procedures being described.

1. Loosen the four (4) screws securing the dome cover and lift to open the dome cover.



2. If necessary, insert a memory card with the metallic contacts facing down into the card slot of the camera.



3. Prepare for cabling connections.
 - a. **If the cable will pass through the surface**, follow the procedures in [Option 1: Cable Passing Through the Surface and Bottom Cable Hole](#) on page 14.
 - b. **If the cable will be routed along the surface**, follow the procedures in [Option 2: Cable Passing Along the Surface and the Camera Side Cable Hole](#) on page 17.

Step 3: Waterproof the Cable Connection

Depending on the installation environment, the cable can pass through the surface and go through the bottom hole of the camera or pass along the surface and through the side hole of the camera. Refer to the instructions below to protect the cable connections.

Option 1: Cable Passing Through the Surface and Bottom Cable Hole

1. Attach the bundled metal cap on the side conduit hole.

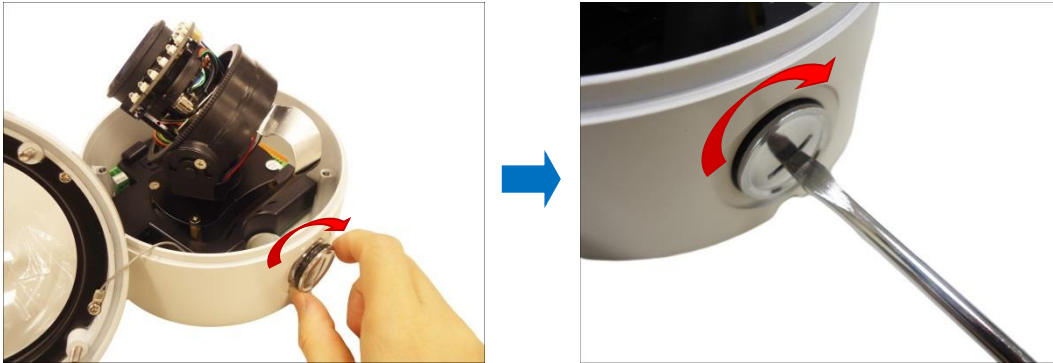

NOTE: Ensure the metal cap is tightly secured to avoid possible water leak.

2. Remove the rubber from the bottom cable hole.

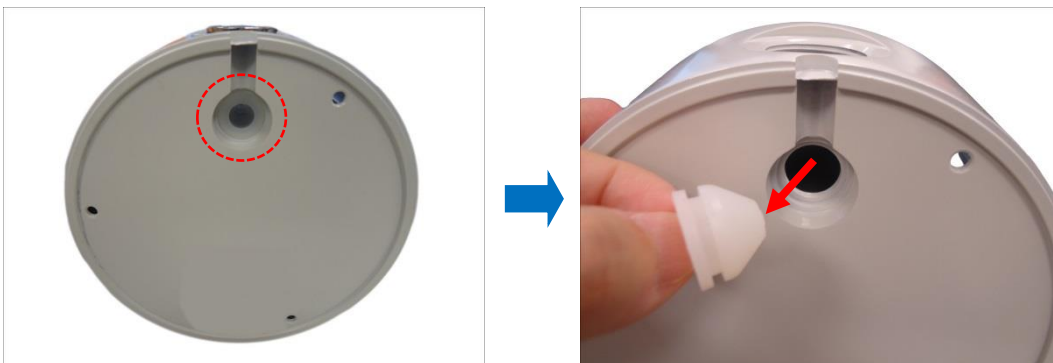

3. Slightly cut off the tip of the rubber, just enough for the rubber to expand and let the Ethernet cable to pass through.



4. Insert the rubber back into the camera bottom hole.



5. Pull the Ethernet cable without connector from the hole on the surface and insert the cable through the camera rubber.



6. Once the Ethernet cable pass through the camera hole, attach the RJ-45 connector (see [How to Attach the RJ-45 Connector](#) on page 33 for detailed information).



7. Pull enough Ethernet cable length to be able to connect to the Ethernet port of the camera.



- 8. Once the cable length is determined, seal the bottom cable hole with silicon to protect it from water leak.



- 9. Mount the camera on the surface using the bundled screws with o-rings.



⚠ CAUTION: When using electric screwdrivers, be careful not to touch the internal camera components while attaching the screws. Since electric screwdrivers vary in sizes, speed, and force, they may bruise and damage the internal camera components.

DISCLAIMER: ACTi will not be responsible for camera damage caused by improper installations or the misuse of equipment for installation.

- 10. Connect the Ethernet cable to the Ethernet port of the camera.



Option 2: Cable Passing Along the Surface and the Camera Side Cable Hole

The camera comes with two (2) glands used to waterproof the side cable hole. Determine the type of waterproof solution that is applicable to your installation requirements and prepare the necessary accessories or purchase extra materials.

Bundled Accessory	Description
<p data-bbox="236 517 421 548">Cable Gland</p> 	<p data-bbox="601 517 1321 741">Use this solution when connecting an Exterior-grade Ethernet cable between the camera and a Power-over-Ethernet (PoE) switch or injector. Exterior-grade Ethernet cables are already waterproof. See Waterproof Solution with Naked Cable on page 18.</p>  <p data-bbox="601 987 687 1014">NOTE:</p> <ul data-bbox="676 1021 1318 1115" style="list-style-type: none"> • Exterior-grade cables are already waterproof. <i>Not included in the package.</i> • Use only RJ-45 connectors without sleeve.
<p data-bbox="236 1180 448 1211">Conduit Gland</p> 	<p data-bbox="601 1180 1335 1503">Use this solution when connecting a standard indoor Ethernet cable between the camera and a Power-over-Ethernet (PoE) switch / injector. A flexible conduit (trade size 1/2") is required to house the Ethernet cable. This solution is recommended when other cable connections, such as audio, DC 12V, etc. will be connected to the camera. See Waterproof Solution with Conduit on page 21.</p> <p data-bbox="601 1536 1299 1615">NOTE: The flex conduit is not included in the package and must be purchased separately.</p>

Waterproof Solution with Naked Cable

This section describes the procedures in using the bundled cable gland and an exterior-grade Ethernet cable.

1. Disassemble the cable gland as shown below:



2. Insert the clamping nut into the Ethernet cable.

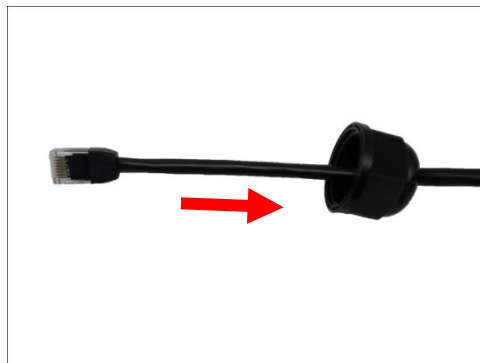

3. Insert the sealing insert with claw.

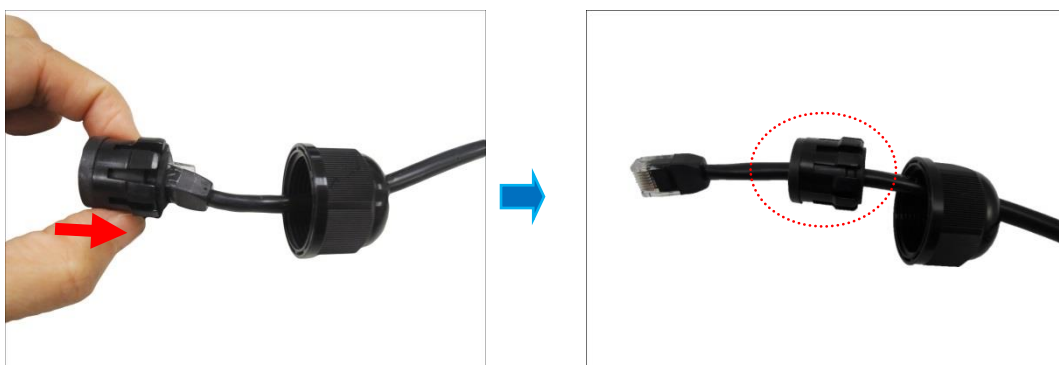

4. Attach the cable gland body to the hole of the camera.



5. Mount the camera onto the surface using the three (3) bundled screws with o-rings.

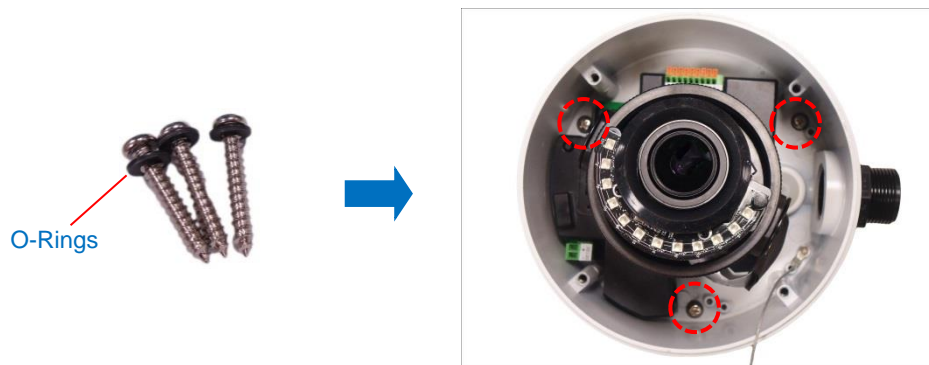

⚠ CAUTION: When using electric screwdrivers, be careful not to touch the internal camera components while attaching the screws. Since electric screwdrivers vary in sizes, speed, and force, they may bruise and damage the internal camera components.

DISCLAIMER: ACTi will not be responsible for camera damage caused by improper installations or the misuse of equipment for installation.

6. Insert the cable through the conduit hole.



7. Connect the cable to the Ethernet port of the camera.

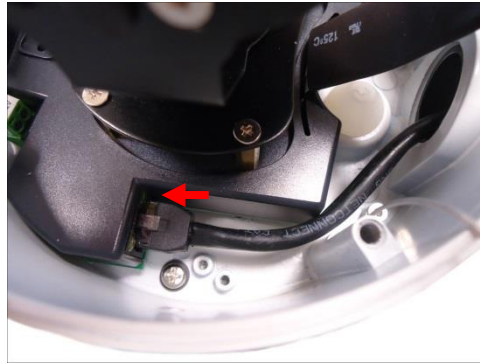

8. Insert the sealing insert with claw into the cable gland body and then attach the clamping nut to complete the cable solution.

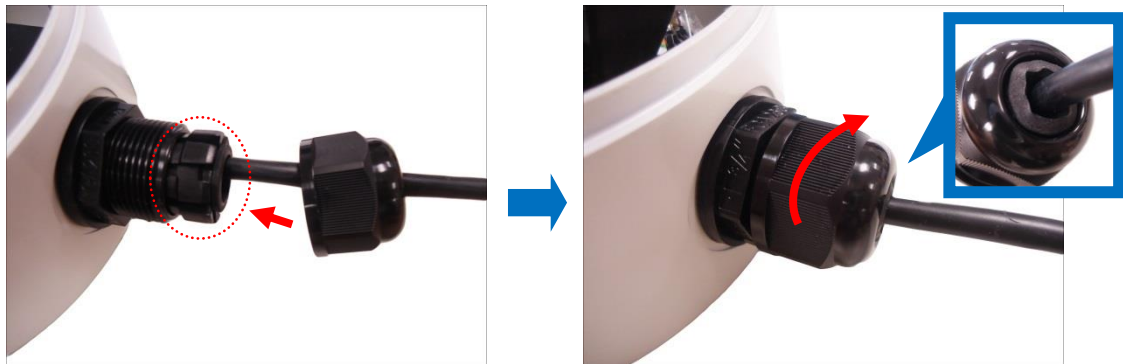



NOTE: Make sure the clamping nut is tightly attached to the cable gland body and the sealing insert is squeezed tightly.

Waterproof Solution with Conduit

This section describes the procedures to waterproof the cabling connections using the bundled conduit gland and flexible conduit. This is the recommended if other input/output devices or an external power adapter will be connected to the camera or when an exterior-grade Ethernet cable is not available.

1. Prepare the following materials for waterproof installation:

Conduit Gland (included in the camera package)	Flexible Conduit 1/2" Trade size (not included in the package)	Network Cable CAT 5 or CAT 6 (not included in the package)
		

2. Disassemble the bundled conduit gland as shown below:

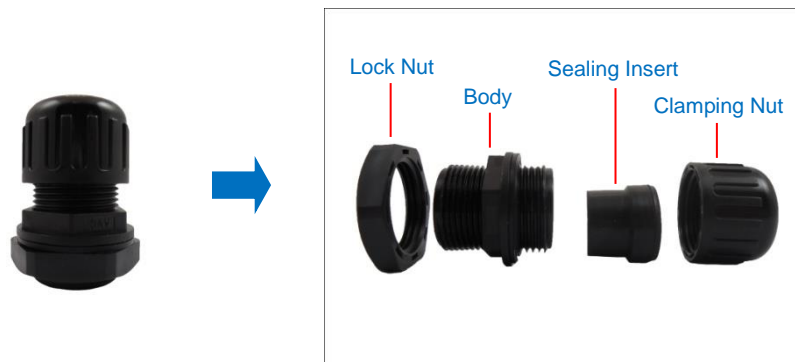

NOTE: In this installation, the conduit gland body can be securely attached to the mount kit; therefore the use of lock nut is not necessary. Please set the lock nut aside.

3. Screw the conduit gland body to the conduit hole of the camera.



9. Mount the camera onto the surface using the three (3) bundled screws with o-rings.

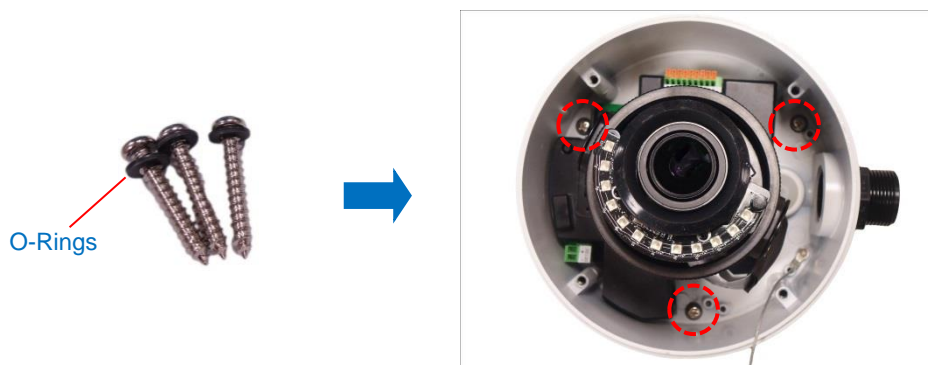

⚠ CAUTION: When using electric screwdrivers, be careful not to touch the internal camera components while attaching the screws. Since electric screwdrivers vary in sizes, speed, and force, they may bruise and damage the internal camera components.

DISCLAIMER: ACTi will not be responsible for camera damage caused by improper installations or the misuse of equipment for installation.

4. Pull the network cable through the flex conduit. If connecting other input/output devices or an external power adapter, pull the cables through the flex conduit without connectors. The terminal blocks will be attached once the cables pass through the camera hole later.



5. Insert the clamping nut through the flex conduit.



6. Insert the sealing insert and attach it at the end of the flex conduit.



7. Insert the network cable and other cables (if any) through the camera conduit hole; pull enough cable length to connect to the camera.



8. Insert the sealing insert to the gland body and then attach the clamping nut to complete the cable solution.

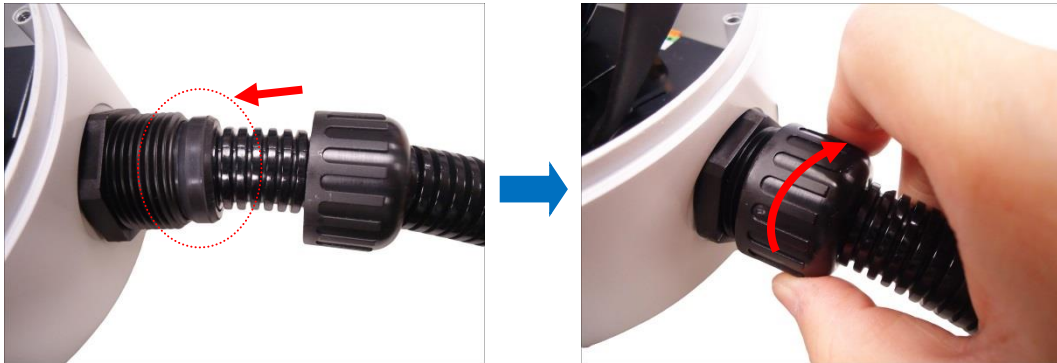

9. Connect the network cable to the Ethernet port of the camera.



10. Connect other cables (if any) to their respective connectors. See [Other Connections](#) on page 27 for detailed instructions.



Example of DC12V Connection



Example of Video-Out (VO) Connection

Step 4: Connect to Network

Connect the other end of the network cable to a switch or injector. Then, connect the switch or injector to a network or PC and a power source. See Power-over-Ethernet (PoE) example connection diagram below.

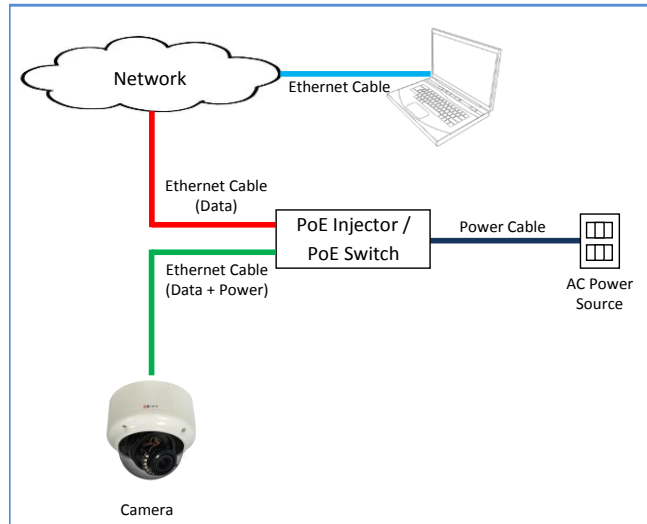

Step 5: Access the Camera Live View

See [Accessing the Camera](#) on page 35 for more information on how to access the Live View of the camera.

Step 6: Adjust the Viewing Angle

Based on the live view, adjust the viewing angle and orientation of the camera.

1. Turn the lens module to pan the camera.
2. Loosen the two (2) tilt adjustment screws and then tilt the camera to desired angle.
3. Tighten the tilt adjustment screws to fix the lens position.



Step 7: Close the Dome Cover

Tighten the four (4) screws to attach the dome cover to the camera body.



Other Connections

This section describes the procedures in preparing an external power adapter or other input and output devices, such as digital or alarm, audio and video that you can connect to the camera. The use of these devices, however, is optional.

Connecting a Power Adapter (Optional)

The camera can be powered by a Power over Ethernet (PoE) switch that is IEEE802.3af compliant. In case of using a non-PoE switch or your PoE switch has limited power supply, you can purchase a power adapter and directly connect the camera to a power outlet.

NOTE: The power adapter is not bundled in the package.

The DC12V terminal block connector is already attached to the camera.



1. Loosen the screws of the two (2) pins on the terminal block.
2. Take note that a standard power adapter cable has two (2) different wires. Connect the wire with the white stripe to the "+" (positive) pin and the other to the "-" (negative) pin.

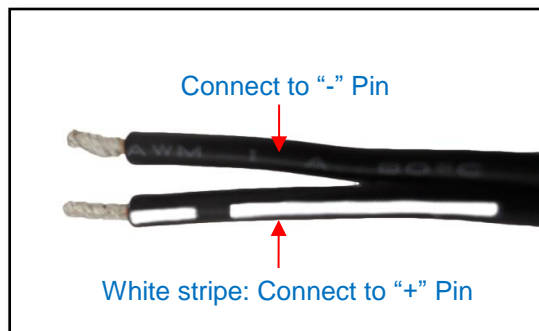

4. Tighten the screws of the pins to secure the wire connection.

Connecting Input / Output Devices (Optional)

Depending on your surveillance needs, you may connect digital input / output, audio input / output, and video output device to your camera.

How to Connect DI/DO Devices

Press and hold the orange tab as you insert the wire through the pin slot, then release the orange tab to secure the wire.

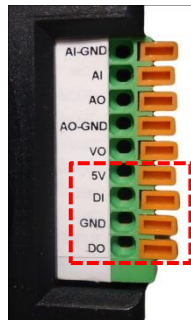

To connect digital input / output devices (DI/DO), map the pins to one of the pin combinations below:

Device	Mapping Instructions	
Digital Output (DO)	DO	Connect the wires of the output device to DO and 5V .
	5V	
Digital Input (DI)	DI	Connect the wires of the input device to DI and GND .
	GND	

The table below shows the DI/DO connection specifications:

Device			
DI	Connection design		TTL - compatible logic levels
	Voltage	To trigger (low)	Logic level 0: 0V ~ 0.4V
		Normal (high)	Logic level 1: 3.3V
DO	Connection design		Transistor (Open Collector)
	Voltage & Current		5V DC, < 50mA

Typical Connection

Based on these specifications, if the DI device has a voltage of 3.3V or the DO device has a voltage of 5V (< 50mA), then the camera can supply internal power to these devices and there is no need to connect the DI/DO device to an external power source.

In this case, wire connection to Pins 1 to 4. Use the **GND** and **DI** pins to connect a DI device and use the **5V** and **DO** pins to connect a DO device. See wiring scheme below:

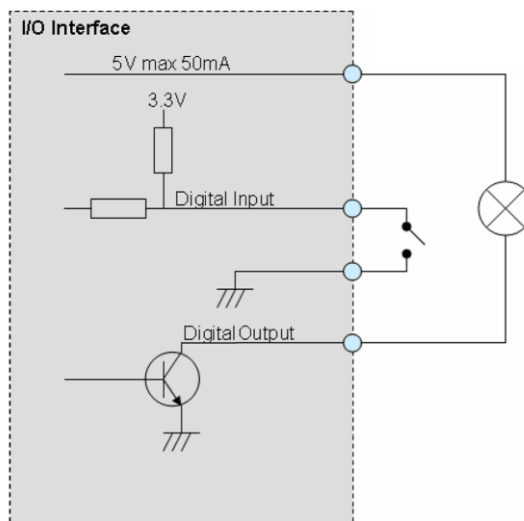

NOTE: For more information on DI/DO connections, please refer to the Knowledge Base article [All about Digital Input and Digital Output](#) downloadable from the link below (<http://Download.acti.com?id=516>).

How to Connect Audio Input / Output Devices

Audio input and output devices, such as a microphone and speaker, can be connected to the camera.

The camera supports microphone-in (mic-in) devices. Meaning, the audio signal from the microphone does not have an amplifier and the camera itself will amplify the signal.

Press and hold the orange tab as you insert the wire through the pin slot, then release the orange tab to secure the wire.

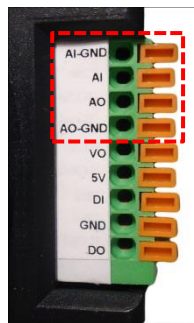

To connect audio devices, map the pins to one of the pin combinations below:

Device	Pin	Mapping Instructions
Audio Output (AO)	AO	Connect the wires of the audio output device to AO and AO-GND .
	AO-GND	NOTE: Must power up the audio output device with external power source, refer to the device documentation for details.
Audio Input (AI)	AI	Connect the wires of the audio input device to AI and AI-GND .
	AI-GND	

NOTE: For more information about AUDIO in connections, please refer to the Knowledge Base article [How to Use Audio-in of ACTi Cameras](http://Download.acti.com?id=534), downloadable from the link below (<http://Download.acti.com?id=534>).

How to Connect a Video Output Device

A video output device, such as the Camera Installation Kit, can be connected to the camera to see the live view during installation through the Camera Installation Kit BNC connection.

Press and hold the orange tab as you insert the wire through the pin slot, then release the orange tab to secure the wire.

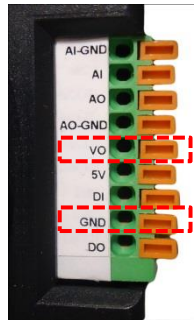

To connect the video output device, map the pins of the BNC cable as follows:

Device	Pin	Mapping Instructions
Video Output (VO)	VO	Connect the wires of the video output device to VO and GND . NOTE: Must power up the video output device with external power source, refer to the device documentation for details.
	GND	

Other Accessories

How to Install / Remove the Memory Card

The camera supports local video recording to a memory card.

NOTE: Supports microSDHC and microSDXC cards.

How to Insert the Memory Card

Insert a memory card into the card slot with the metallic contacts facing down the camera. Push the card until it clicks into place.

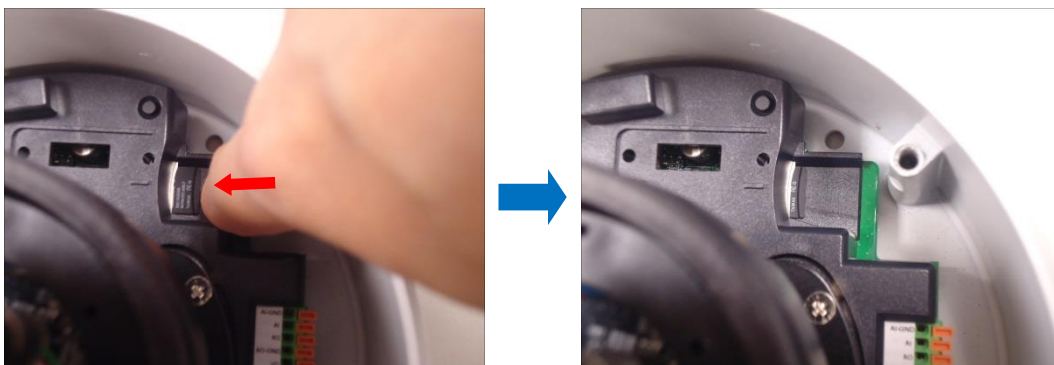

How to Remove the Memory Card

In case there is a need to remove the card, make sure to access the camera Web Configurator to safely “unmount” the card first (see the camera Firmware manual for more information). Once unmounted from the firmware, push the card to eject it from the slot.

How to Attach the RJ-45 Connector

1. Prepare the following tools:
 - a. RJ-45 connector
 - b. Crimping tool
 - c. Scissors
2. Cut about one (1) inch into the plastic sheath from the end of the cable.

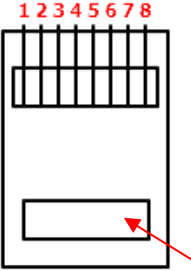

3. Unwind the wires and arrange them according to the color sequence below.

	1	Stripe Orange
	2	Orange
	3	Stripe Green
	4	Blue
	5	Stripe Blue
	6	Green
	7	Stripe Brown
	8	Brown

4. Straighten out the wires and use the scissors to make a straight cut ½ inch from the cut end.

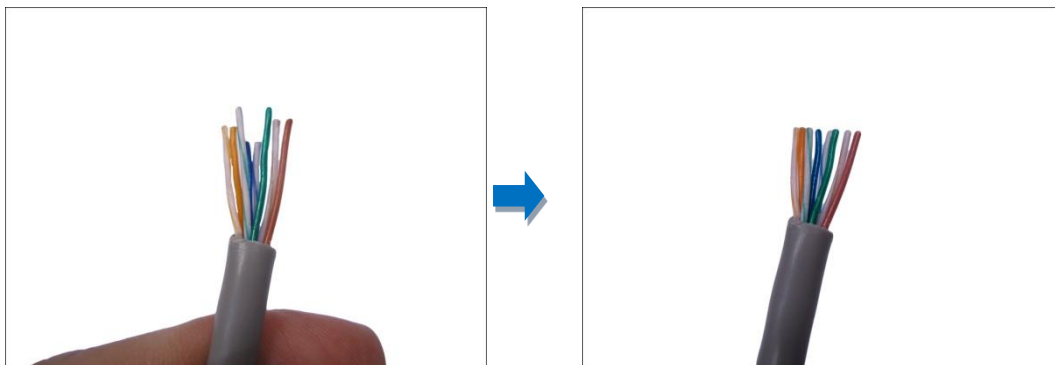

5. With the RJ-45 connector tab facing down, push down the wires into the connector all the way to the end.

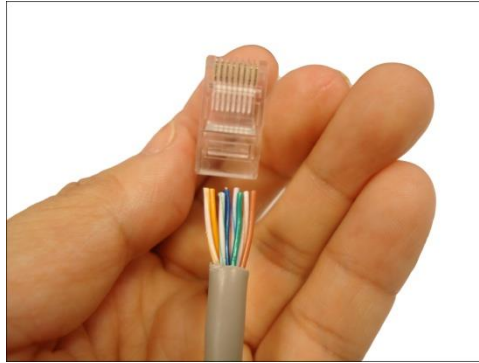

6. Place the connector into the crimping tool, and cinch down to secure the RJ-45 connector to the Ethernet cable.



Accessing the Camera

Configure the IP Addresses

In order to be able to communicate with the camera from your PC, both the camera and the PC have to be within the same network segment. In most cases, it means that they both should have very similar IP addresses, where only the last number of the IP address is different from each other. There are 2 different approaches to IP Address management in Local Area Networks – by DHCP Server or Manually.

Using DHCP server to assign IP addresses:

If you have connected the computer and the camera into the network that has a DHCP server running, then you do not need to configure the IP addresses at all – both the camera and the PC would request a unique IP address from DHCP server automatically. In such case, the camera will immediately be ready for the access from the PC. The user, however, might not know the IP address of the camera yet. It is necessary to know the IP address of the camera in order to be able to access it by using a Web browser.

The quickest way to discover the cameras in the network is to use the simplest network search, built in the Windows system – just by pressing the “Network” icon, all the cameras of the local area network will be discovered by Windows thanks to the UPnP function support of our cameras.

In the example below, we successfully found the camera model that had just connected to the network.

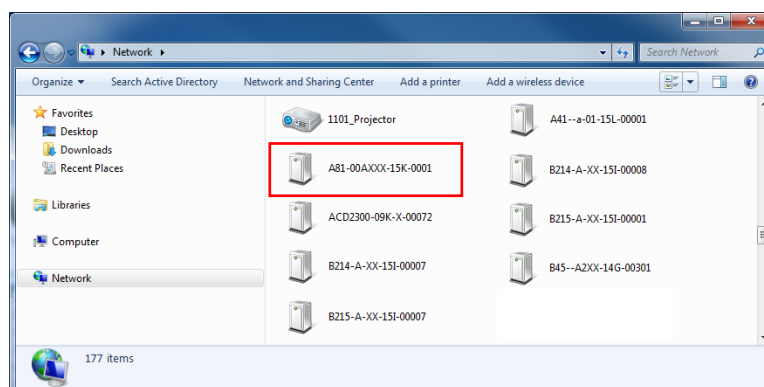

Double-click the mouse button on the camera model name, the default browser of the PC is automatically launched and the IP address of the target camera is already filled in the address bar of the browser.

If you work with our cameras regularly, then **there is even a better way to discover the cameras in the network** – by using **IP Utility**. The IP Utility is a light software tool that can not only discover the cameras, but also list lots of valuable information, such as IP and MAC addresses, serial numbers, firmware versions, etc, and allows quick configuration of multiple devices at the same time.

The latest IP Utility can be downloaded for free from http://www.acti.com/IP_Utility

When you launch IP Utility, the list of connected cameras in the network will be shown. See sample illustration below:

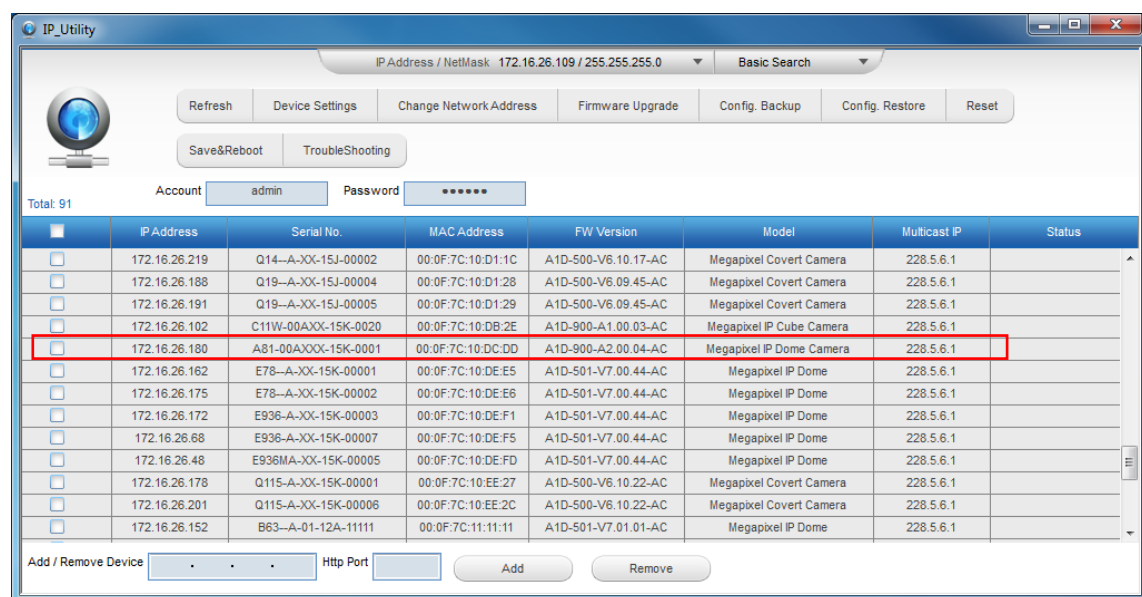

You can quickly notice the camera model in the list. Click on the IP address to automatically launch the default browser of the PC with the IP address of the target camera filled in the address bar of the browser already.

Use the default IP address of a camera:

If there is no DHCP server in the given network, the user may have to assign the IP addresses to both PC and camera manually to make sure they are in the same network segment.

When the camera is plugged into network and it does not detect any DHCP services, it will automatically assign itself a default IP:

192.168.0.100

Whereas the default port number would be **80**. In order to access that camera, the IP address of the PC has to be configured to match the network segment of the camera.

Manually adjust the IP address of the PC:

In the following example, based on Windows 7, we will configure the IP address to **192.168.0.99** and set Subnet Mask to **255.255.255.0** by using the steps below:

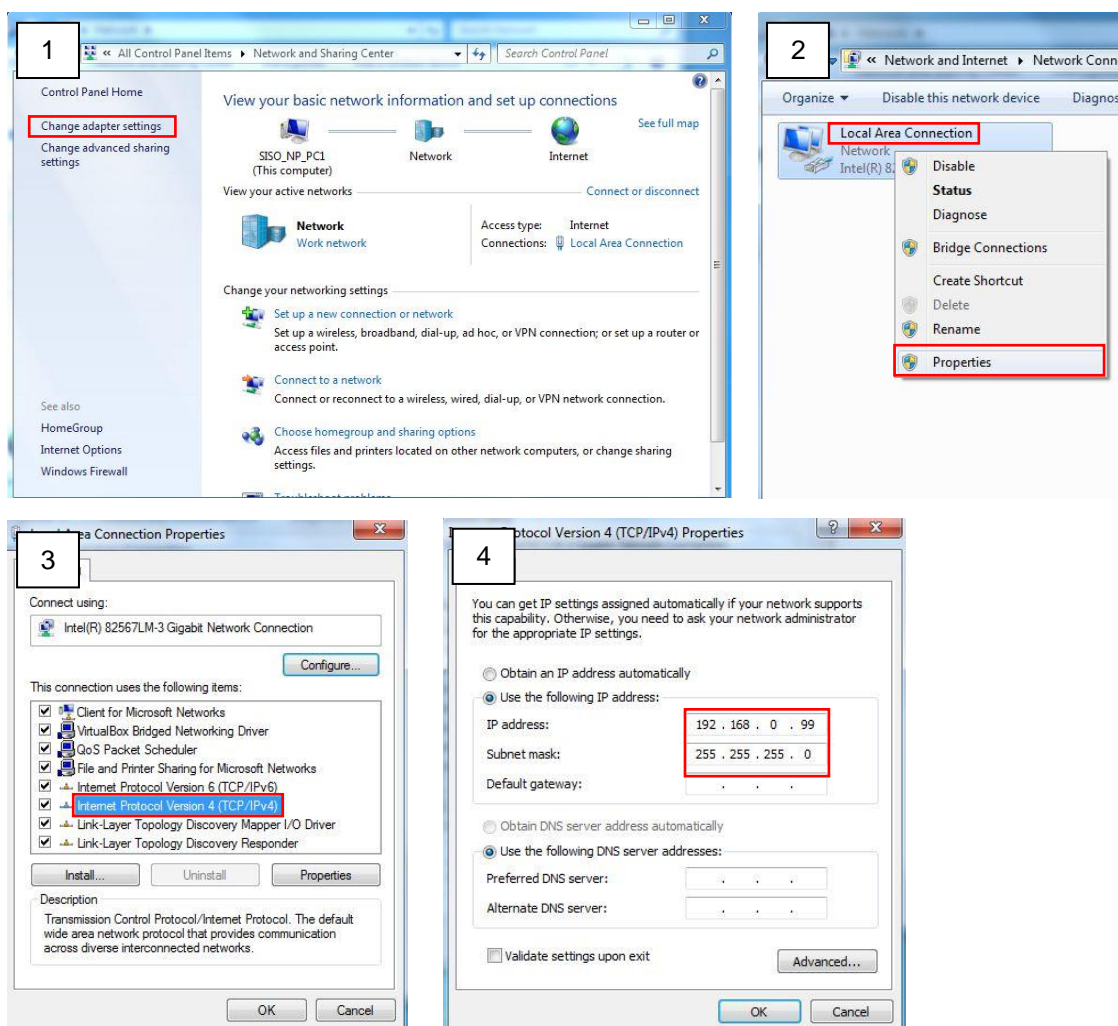

Manually adjust the IP addresses of multiple cameras:

If there are more than 1 camera to be used in the same local area network and there is no DHCP server to assign unique IP addresses to each of them, all of the cameras would then have the initial IP address of **192.168.0.100**, which is not a proper situation for network devices – all the IP addresses have to be different from each other. The easiest way to assign cameras the IP addresses is by using **IP Utility**:

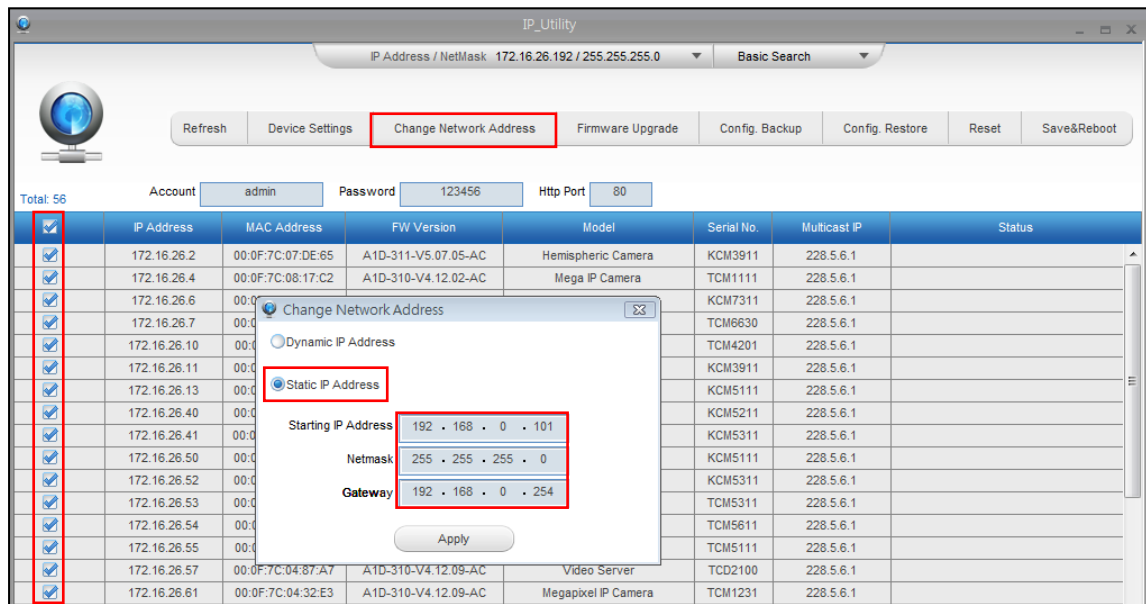

With the procedure shown above, all the cameras will have unique IP addresses, starting from 192.168.0.101. In case there are 20 cameras selected, the last one of the cameras would have the IP 192.168.0.120.

Later, by pressing the “Refresh” button of the IP Utility, you will be able to see the list of cameras with their new IP addresses.

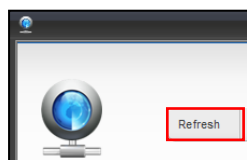

Please note that it is also possible to change the IP addresses manually by using the Web browser. In such case, please plug in only one camera at a time, and change its IP address by using the Web browser before plugging in the next one. This way, the Web browser will not be confused about two devices having the same IP address at the same time.

Access the Camera

Now that the camera and the PC are both having their unique IP addresses and are under the same network segment, it is possible to use the Web browser of the PC to access the camera.

Full functionality is provided only for **Microsoft Internet Explorer**.

The browser functionality comparison:

Functionality	Internet Explorer
Live Video	Yes
Live Video Area Resizable	Yes
PTZ Control	Yes
Capture the snapshot	Yes
Video overlay based configuration (Motion Detection regions, Privacy Mask regions)	Yes
All the other configurations	Yes

When using Internet Explorer browser, the ActiveX control for video stream management will be downloaded from the camera directly – the user just has to accept the use of such control when prompted so. No other third party utilities are required to be installed in such case.

The examples in this manual are based on Internet Explorer browser in order to cover all functions of the camera.

Assuming that the camera's IP address is **192.168.0.100**, you can access it by opening the Web browser and typing the following address into Web browser's address bar:

<http://192.168.0.100>

Upon successful connection to the camera, the user interface called **Web Configurator** would appear together with the login page. The HTTP port number was not added behind the IP address since the default HTTP port of the camera is 80, which can be omitted from the address for convenience.

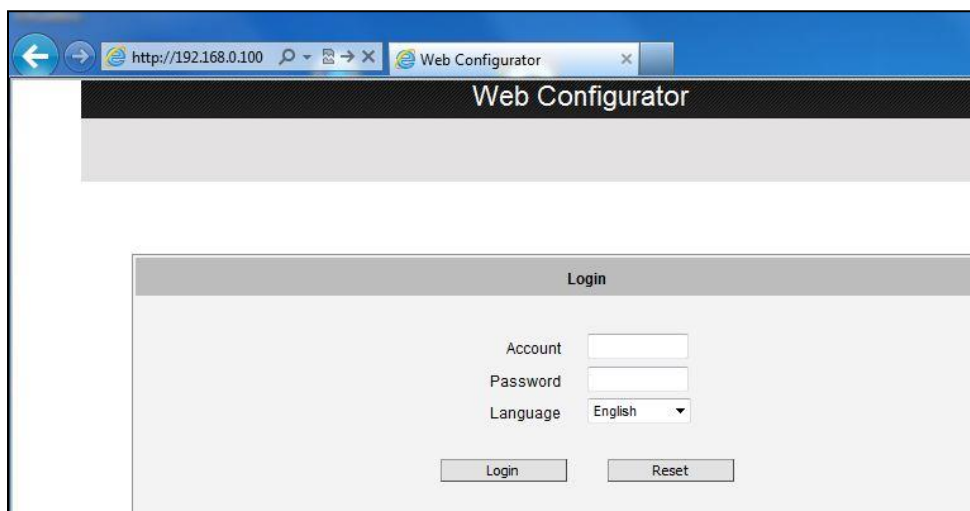

Before logging in, you need to know the factory default Account and Password of the camera.

Account: **Admin**

Password: **123456**

For further operations, please refer to the **Firmware User Manual**.



Copyright © 2015, ACTi Corporation All Rights Reserved

7F, No. 1, Alley 20, Lane 407, Sec. 2, Ti-Ding Blvd., Neihu District, Taipei, Taiwan 114, R.O.C.

TEL : +886-2-2656-2588 FAX : +886-2-2656-2599

Email: sales@acti.com